

1.0 Application

All LCI and RTC infrared closed atmosphere belt furnaces with source/multi-port OSS sampling system. Use this field modification on sample systems using the standard RTC manifold with common exhaust ports to isolate the source nitrogen gas from the chambers not being sampled.

2.0 Scope

To isolate source gas valve exhaust port from non-selected zone port valve exhaust.

3.0 Tools

The following tools are required:

- (1) Solenoid valve (Source Gas Isolation valve) with tube fittings and wire (kit).
- (2) Open-end wrenches
- (1) Tube cutter

4.0 Preparation

1. Disconnect power from furnace.
2. Close off facility Process gas supply valve(s).

5.0 Location

1. Open lower furnace panels and locate the OSS Sample System valve manifold and Source Gas Line (see Figure 7-2).
2. Reference Drawing: 801-090776-01 Rev. 1.

6.0 Valve Ports and Orientation

1. On the solenoid valve, locate the ports identified as "1" and "2".
2. Turn valve so ports are as indicated in Figure 6-1.
3. The valve should be positioned upright in a horizontal tubing run with the electric solenoid above the valve body. See Figure 6-1.

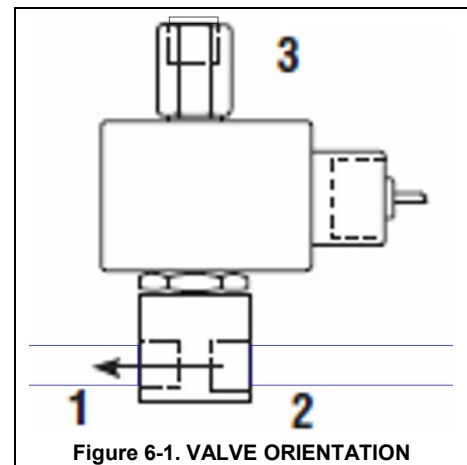

7.0 Procedure

1. Locate the Source Gas Line (see Figure 7-2).

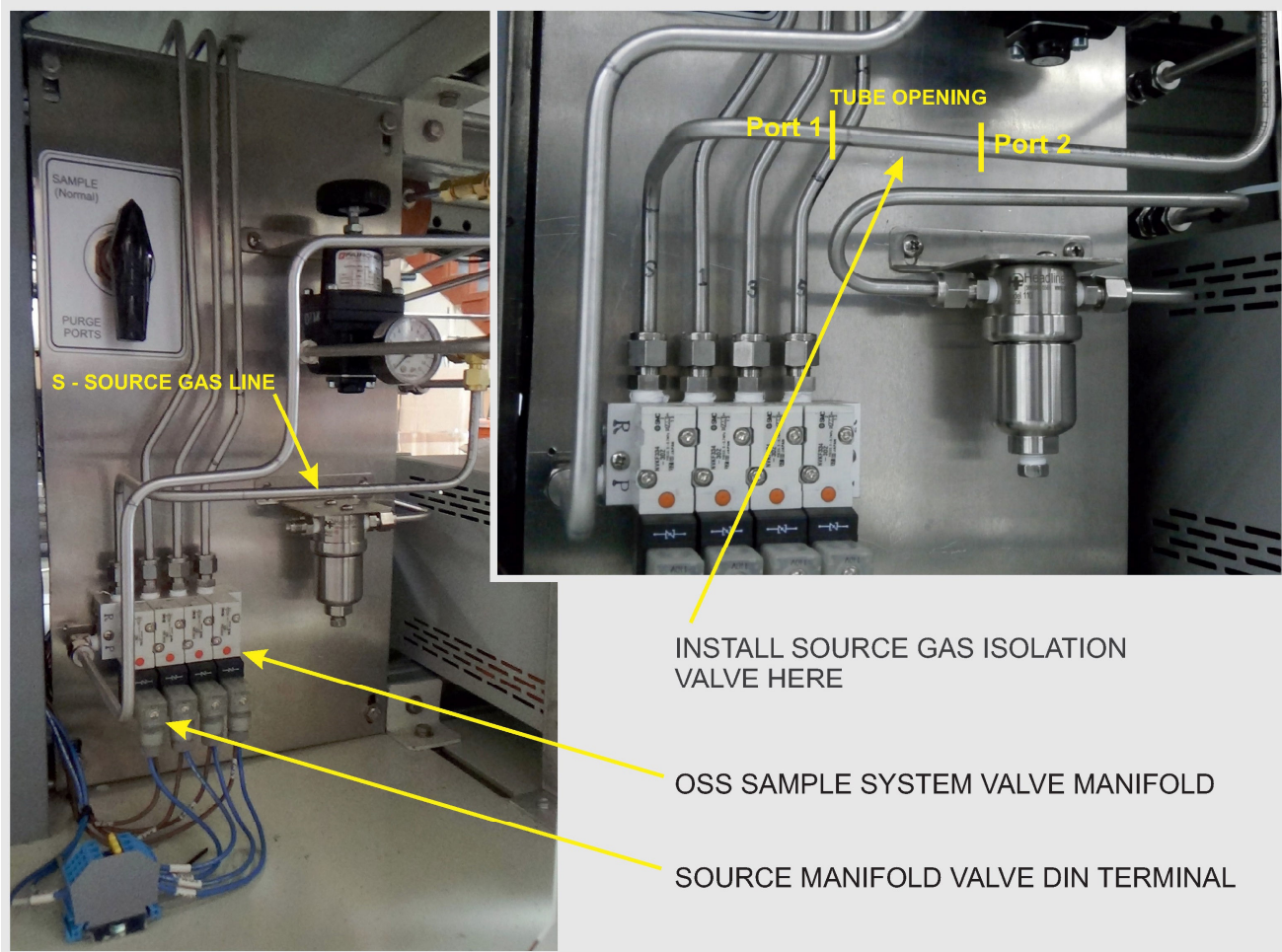

Figure 7-2. LOCATION OF ISOLATION VALVE & MANIFOLD

2. Mark tubing cut lines in two (2) places, 6.3 cm (2.5 inches) apart such that the Source Gas Isolation valve can be installed in a horizontal run with the solenoid vertically oriented above valve. (See Figures 6-1 and 7-2).
3. Cut tubing with a tube cutter on cut lines to create tube opening.
4. Gently spread apart tube opening and carefully insert Source Gas Isolation valve and slide tube fittings over tube ends. Position valve according to location of Ports 1 and 2 shown in Figure 6.1 and 8-7. Orient solenoid valve vertically.
5. Tighten nut on tube as shown in figure 7-3.

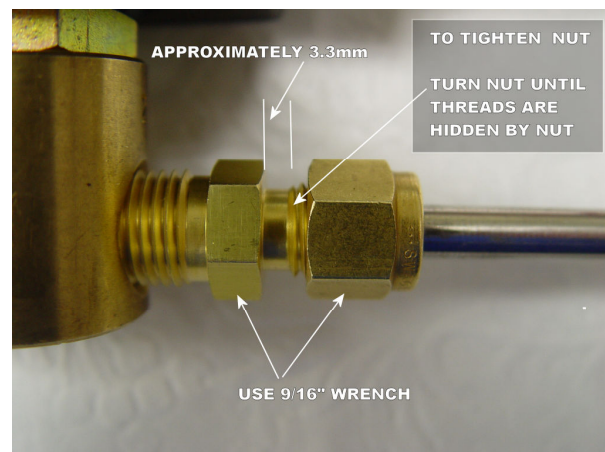

Figure 7-3. Tightening Tube Fitting

8.0 Electrical

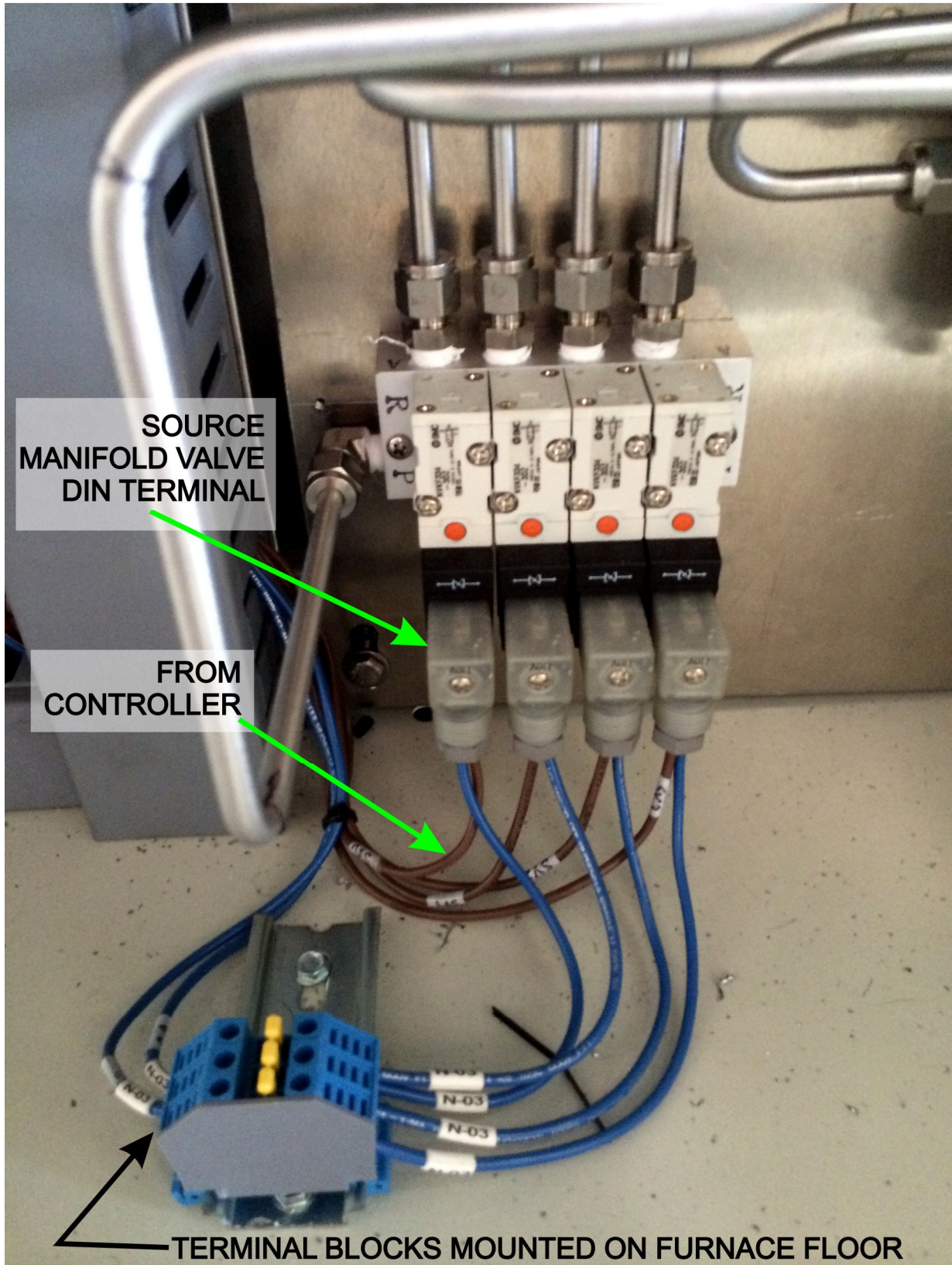
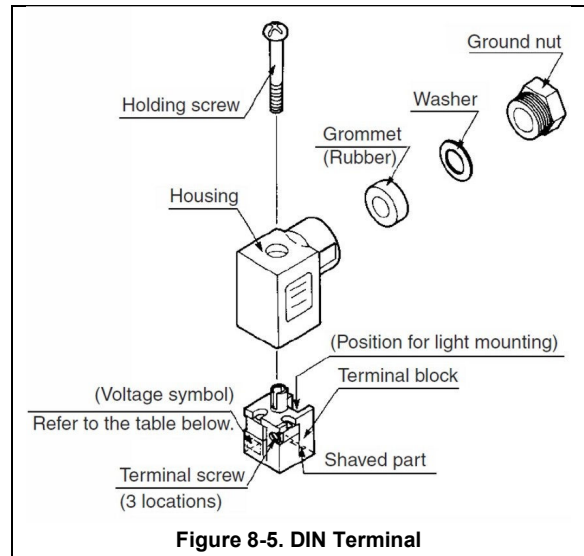

Figure 8-4. SOURCE MANIFOLD VALVE DIN TERMINAL

8.1 Electrical

1. Install the grey terminal block, green/yellow grounding terminal block and end cap next to the blue terminal blocks mounted on the furnace floor (Figure 8-4 and 8-7) on page 5.
2. Connect wires from the Source Manifold Valve DIN Terminal (Figures 8-4, 8-6 & 8-7) as follows:

- a. Remove DIN Terminal from Source Manifold Valve as follows (ref Figures 8-4 and 8-5).
- b. Remove the holding screw and separate the connector from the solenoid.
- c. Insert a flat head screwdriver into the notch on the bottom of the terminal block and pry it up, separating the terminal block from the housing,
- d. Remove brown wire by loosening screw on terminal #2, separate brown wire from the housing and connect this brown wire to grey terminal block.
- e. Connect short brown wire from kit to terminal #2.



- f. Feed other end of short brown wire from kit through housing opening and connect to grey terminal block (Figure 8-7).
3. Re-assemble DIN Terminal as follows (ref Figure 8-5):
 - a. Place housing over terminal block and press into place.
 - b. Firmly insert terminal block over Source Manifold Valve connections.
 - c. Insert and tighten holding screw into terminal block housing.
 4. Connect the brown wire from the Source Isolation Valve solenoid to the grey terminal block on the furnace floor (Figure 8-4 and 8-7).
 5. Connect the blue wire from the Source Isolation Valve solenoid to a blue terminal block on the furnace floor (Figure 8-7), any one will do.
 6. Connect the green (or yellow/green) wire from the Source Isolation Valve solenoid to the yellow/green terminal block on the furnace floor (see Figure 8-7).
 7. Completed wiring should now look similar to Figure 8-7. Note: in Figures 8-6 and 8-7 wires for other port solenoid valves not shown for clarity.

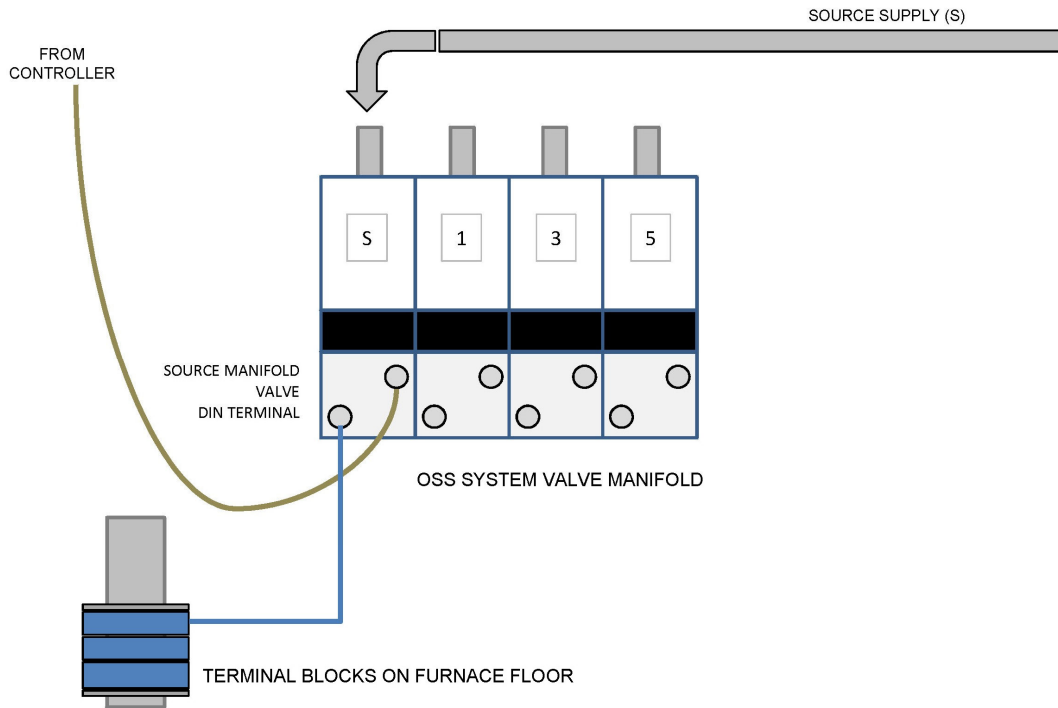

Figure 8-6. SOURCE MANIFOLD WIRING (EXISTING)

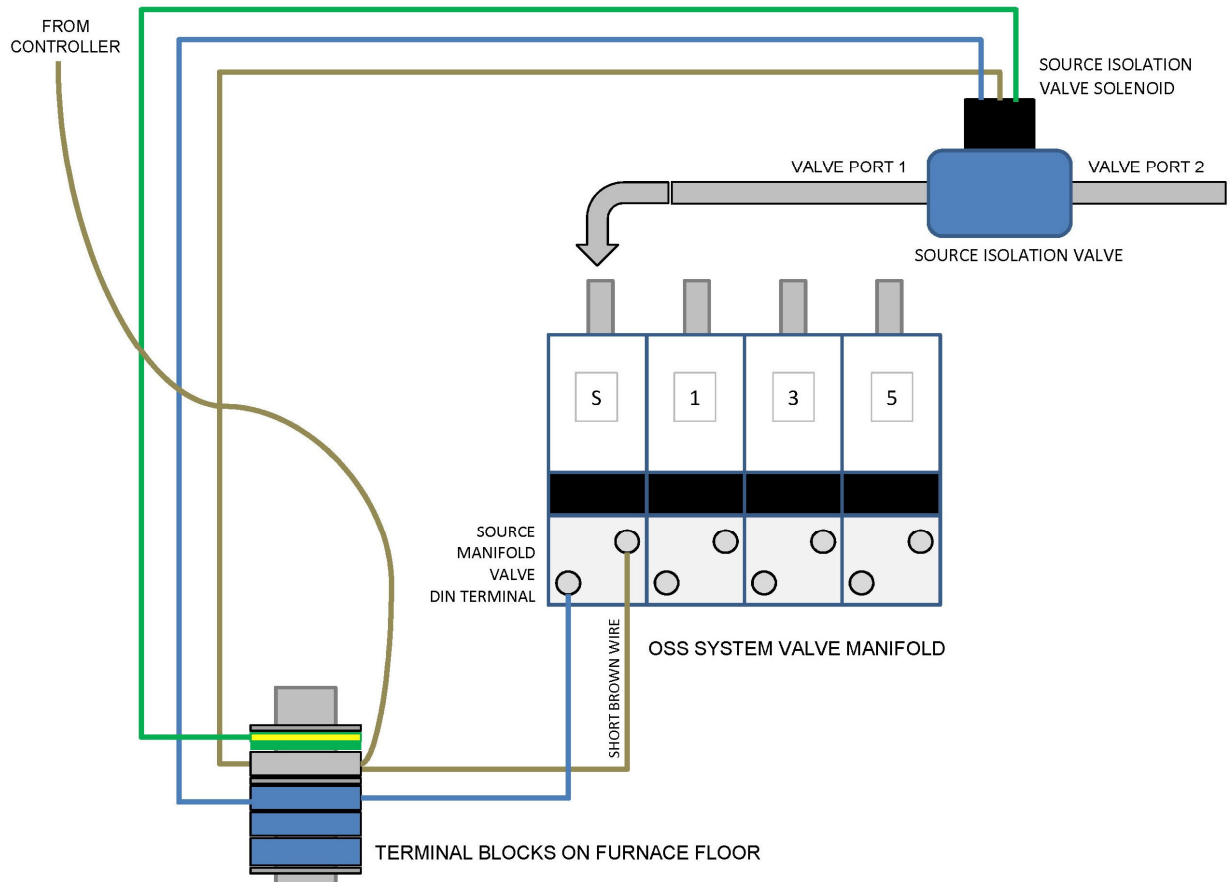

Figure 8-7. SOURCE MANIFOLD AND ISOLATION VALVE WIRING (AS-MODIFIED)

9.0 Test

1. Connect power to furnace.
2. Open facility Process gas supply valve(s).
3. Check Source Gas Isolation valve port 2 for leaks.
4. Using furnace software, enable O2 Sampling and select source. Check Source Gas Isolation valve port 1 for leaks.
5. Close up furnace and turn over to LCI for process QA testing.