

10.1 Oxygen Analyzer



Certificate of Calibration

Certificate Number: 19091951 *Date:* 19 September 2019

Approved Signatory: Joe Manic/Mike Zelent/Mick White

Customer: TP SOLAR INC.
(Illinois Instruments Inc.)

Customer Ref: 43423/24403 PO: PO04014-1

Systech Ref: SO/32547

Tag No./Part No. -

Instrument: MODEL EC913 O₂ RACE ANALYSER

Serial Number: 900G51346

Period of Calibration: 12 months

Next Calibration Due: September 2020

All measurements were performed in an environment with ambient temperature and humidity.

Signature:

A handwritten signature in black ink, appearing to read 'J Manic', is written over a horizontal line.

The analyser was tested in accordance with Systech procedures.
Results are within manufacture specifications.

The instrument was gas tested by passing air through the cell and setting the span so that the instrument reads 20.9%. The zero was checked by passing Nitrogen through the cell.

A calibrated sample of 80ppm Oxygen in Nitrogen was then passed through the cell and the reading noted.

Gas Specification:

<i>Manufacturer:</i>	Air Products Ltd
<i>Product:</i>	80ppm O ₂ in N ₂
<i>Certificate Ref:</i>	ISO 6141, ISO 6142 & ISO 6143
<i>Material Ref:</i>	299707
<i>Source Location:</i>	0234
<i>Inspection Lot:</i>	040007496356
<i>Date of Analysis:</i>	24/06/2019
<i>APL Analysis Result:</i>	Oxygen: 80.1 ppm \pm 0.4 ppm Nitrogen: Balance
<i>Systech Analysis Result:</i>	Oxygen: 80.1 ppm
<i>Date:</i>	19 September 2019
<i>Calibrated by:</i>	Joe Manic/Mike Zelent/Mick White
<i>Signature:</i>	



Test Certificate: 900 / 9500

Serial No: 900051346

Customer: TP SOLAR INC.

System Ref No: 32547

Customer Order No: 43423/24403 P004014-1

Software Version: EC900 02.21

Test Instrument: Fluke 800 Series m001

Main PCB No: P7541

Display PCB No: P7681

Cell Part No: 900057/900260

Cell Serial No: 390588/38878

Chassis Earth	Specified Value	Actual Value	Chassis Earth	Specified Value	Actual Value
TP 2	-15.0 ± 0.5V	-14.98V	TP 8	+3.0 ± 0.02 V	+2.995
TP3	+15.0 ± 0.5 V	+14.93V	TP 9	+5.0 + 0.2 V / -0.16V	+5.07V
TP 7	-5.0 ± 0.5 V	-5.00V			
SELECT?	0		T. Comp.	27.8°C @ 28°C	
DAMP 1 to 6	1		LIN Table	<input type="checkbox"/> % <input checked="" type="checkbox"/> H2 <input type="checkbox"/> STD	
POST DAMP <10.0ppm	60			Normal	Recorded
POST DAMP >10.0ppm	15		TP1 (Range 5)	0.27	+0.270V
POSTDAMP?1 0	15		TP1 (Range 6)	2.992	+2.995V
FDAMP	1		C Fact 1	27.77	28.57758
SPAN	① 1.225067 ② 0.339986		C Fact 2	6666.66	6578.329101
SAVESPANS	① 1.225067e0 ② 0.339986e-1				
ZERO	① 0.000 ② 0.000				
MINANHI	5ppm	ANOPTN	0	MFDAMP	20
	MFSPAN				1
Analogue output 1 - Y (N)		Analogue output 2 - Y (N)		Analogue output 3 - Y (N)	
4-20mA <input checked="" type="checkbox"/>	0-20mA <input checked="" type="checkbox"/>	0-10v <input checked="" type="checkbox"/>	4-20mA	0-20mA	0-10v
Alarms Y (N)	Alarm 1 N/A	Alarm 2 N/A	Fault	<input checked="" type="checkbox"/>	
Auto calibration Y (N)	Tested Y (N)	9500 Control Y (N)	Tested Y (N)	Invert Y (N)	
Race cell only:	Level: 2000ppm	Hyst: 1000ppm	Xdly:	60seconds	
Calibration Gas	Cylinder Actual		Instrument Reading		
Zero Gas			0.74 PPM		
N2			2.68 PPM		
80 ppm/2%	80.1 ± 0.4 PPM		80.1 PPM		
Seal off Value			OK.		
Pressure Test: - Pass (N/A)	Flow Alarm: - Y (N)	Flow Alarm: - Pass (N/A)			
P. A. TESTED	Response Time = 2mins 44secs	PASSWORD =	1234		

Modifications or Special Alterations:

Tested By: BSOPHAM Signature: BS Date: 19-9-19

EC900 Process Oxygen Analysers



The EC900 offers unsurpassed accuracy, reliability and flexibility under the most demanding on-line operating conditions



Features & Benefits

- Specific to oxygen
- Ambient air or traceable gas calibration
- Microprocessor controlled functions
- Long life, maintenance-free, disposable oxygen sensors
- Fast response. Ultra fast response version also available
- This instrument has a 36 month warranty which covers any faulty workmanship and normal component failure relating to electronic circuit cards
- Large, autoranging LED display
- Unaffected by vibration or position
- Sturdy, reliable construction with three sensor options
- Insensitive to sample flow rate - percentage through ppm
- Nitrosave flushing gas control option

Conforms to European Directives:

Electromagnetic Compatibility Directive 2004/108/EC Low Voltage Directive 73/23/EEC

Unmatched in High Performance

Applications

Chemical / Petrochemical

Chemical Production
High Purity Gas Production
Hydrocarbon Refining
Natural Gas Transmission

Curing

Electron Beam
Ultraviolet

Electronics

Reflow / Wave Soldering
Solder Powder Production
Semiconductor Furnaces
Gas Quality

Metals

Heat Treating / Annealing
Steel Production
Alloys and Powdered Metals

Pharmaceutical

Inert Packaging
Vessel Blanketing
Fermentation

Process

Ceramics
Combustion Analysis
Contact Lens Manufacturing
Food Packaging
Glass Fibre Optics
Inert Gas Welding
Lamp Manufacturing

General

Controlled Environments
R & D
Glove Boxes
Oxygen Deficiency

Unmatched Performance

Systech Illinois has long been recognised worldwide as a leader in oxygen analysis.

Utilising a variety of specially engineered electrochemical fuel cells, the EC900 Oxygen Analysers are designed to monitor oxygen within most industrial gases and atmospheres. These highly advanced instruments incorporate user-friendly software and the highest quality sensors to provide accurate, reliable results.

Whatever your measuring range, the EC900 series has an analyser to suit your needs.

Cabinetry & Mounting

Three different configurations to match your needs.

- NEMA 4X / IP66 waterproof and weatherproof
- 19 in. rack mount
- Panel or bench mount
- UL and CUL approved Ex-proof

Explosion Proof Version

- UL and CSA approved
- Split architecture version for:
Class I, Groups B, C & D; Class II and Class III
- Nema 4/7 rated

Operator Interface /Diagnostics

- User-friendly menu
- Read-only mode available
- Diagnostic capabilities
- Fault alarms

Optional Nitrosave Feature

- Control of Nitrogen or flushing gas
- Reduced gas consumption
- Improved productivity
- Reduced product wastage
- Better quality control
- Integrated electronics with analyser
- Control hardware available

Outputs & Alarm Options

For charting, process control, or remote monitoring.

- USB and RS485
- Analogue outputs (one or three channels)
- High / low alarms
- Fault alarms

Trace On-Line Oxygen Analysis

Sensor Selection

No need to compromise! Now you can match sensor to application for the best possible reliability and performance. All sensors are manufactured to rigid tolerances and exacting production specifications.

EC920



Principle of Operation

The EC900 Oxygen Analysers use a variety of electrochemical fuel cells for the detection of oxygen. When oxygen diffuses to the cathode of the cell, a current output is produced directly proportional to the concentration of oxygen in the sample gas.

Specialising in trace oxygen measurements, Systech Illinois' sensors are used in applications from ppb up to 100% oxygen. In addition, sensors can be used on gas streams such as hydrogen, combustibles, hydrocarbons and inert gases.

All Systech Illinois' sensors are easily calibrated to ambient air. For ISO purposes and in specific applications, traceable calibration gases can be used to meet the most demanding quality assurance programmes.

Trace (part per million) Sensor

The trace sensor is designed for measuring 0.1ppm – 1% oxygen in most industrial gas streams. Can be calibrated to air. This sensor when used in a normal operating range typically lasts 3 – 5 years.

Sensor RACE™

The RACE™ Sensor is a breakthrough in electrochemical technology. Our patented design* prevents the sensor from being saturated by high levels of oxygen. With TURBOPURGE™ levels as low as 20ppm can be reached from ambient air within 2 minutes. This sensor is unaffected by hydrocarbons or volatile atmospheres making it the ideal choice in applications such as wavesolder and reflow ovens.

The RACE™ Sensor is maintenance-free, requires only occasional calibration and has no caustic electrolyte to monitor or replace. The RACE™ Sensor carries a 3 year limited warranty.

Percent Sensor

The Systech Illinois percent sensor is capable of accurate measurements from 0 – 100% oxygen. Unlike most electrochemical sensors, this sensor is not affected by acid gases such as carbon dioxide.

EC930



EC910



Ex- Proof



Sampling Systems

- Bypass flowmeter
- Pressure regulator
- Sample pump
- Flow alarm

* UK Patent no. 2324870. USA Patent no. 5929318

EC900 Process Oxygen Analysers



EC910
Bench/Panel Mount
190H x 237W x 410D (mm)
7.9 kg



EC920
IP66/NEMA 4X
Wall Mount/Weatherproof
460H x 380W x 160D (mm)
15.5kg



EC930
Rack Mount 4U - 19 inch
Houses 1 or 2 Analysers
178H x 484W x 410D (mm)
9.7kg (single unit)

Technical Specifications

Sensor Type	Trace	Race	Percent
Ranges	0.1ppm - 1%	0.1ppm - 30%	0.3% - 100%
Accuracy: >10ppm	±2% of reading at 20°C ±5% of reading over temperature range	±2% of reading at 20°C ±5% of reading over temperature range	±0.2% of calibrated value at 20°C ±1% of calibrated value over temperature range
<10ppm	±2% of reading + 0.4ppm at 20°C ±5% of reading + 0.6ppm over temperature range	±2% over temperature + 0.4ppm at 20°C ±5% over temperature + 0.6ppm over temperature range	
Response Time	90% within 30sec	Air to 20ppm within 2min	90% within 30sec
Measuring Cell Type	Electrochemical, percentage, trace and RACE™ Cell (US & UK) patents		

Operating Conditions

Sample Inlet Pressure	0.25 - 2 Barg, 3-30psi
Sample Flow Rate	Approximately 140 cc/min
Sample Temperature	-5 to 50°C
Ambient Temperature	-5 to 50°C, RH 0-99% non-condensing
Sample Connections	1/8" OD compression fittings, as standard
Communications	USB and RS485
Unsuitable Gases	Acid gases, corrosives and solvents in significant concentration

Power Requirements

Power Supply	115/230VAC selectable
Display Type	4-digit high-visibility LED

Options

High/Low Alarms	2 Volt-free changeover contacts. Rated 240V 3A
Analogue Outputs	Analogue output channels: scaleable 0-10V, 4-20mA or 0-20mA all isolated. Option for one channel or three.
Autocalibrate	Provision for remote cal start and autocal in progress
Sample Stream Options	Bypass flowmeter, sample pump, flow alarm, stainless steel sample system in place of brass/copper. Sample conditioning advice available.
Nitrosave	O ₂ measurement and control system EC9500.
Ex Proof	Consult factory for various configurations.

Systech Illinois have over 30 years experience of providing analysis solutions for a wide range of industries. From our manufacturing plants in the UK and U.S. we produce gas analysers for industrial process industries, headspace analysers for monitoring gas flushing of food products and our range of permeation analysers.

Systech Instruments Ltd (UK)
17 Thame Park Business Centre,
Wenman Road,
Thame, Oxfordshire OX9 3XA
Tel: +44 (0)1844 216838
Fax: +44 (0)1844 217220
E-mail: sales.uk@systechillinois.com
www.systechillinois.com

Illinois Instruments, Inc (U.S.)
2401 Hiller Ridge Road
Johnsburg, Illinois 60051
U.S.A.
Tel: +1 815 344 6212
Fax: +1 815 344 6332
E-mail: sales.usa@systechillinois.com
www.systechillinois.com

Illinois Instruments (Thailand)
6th fl Nopnarong Bldg No7
Ladprao23, Jatujak, Bangkok
10900 Thailand
Tel: +66 (0)2938 0798
Fax: +66 (0)2938 1058
E-mail: sales.ap@systechillinois.com
www.systechillinois.com

Systech Illinois (China)
Room 1105 Forte Building
No. 910 Quyang Rd, Hongkou district,
Shanghai, China 200434
Tel: +86 21 65533022
Fax: +86 21 65539651
Email: info@systechillinois.cn
www.systechillinois.cn



SERIES EC900 OXYGEN ANALYZERS

(Covers MK3 USB models)

OPERATION MANUAL

Version 4.9

5th May 2016



Illinois Instruments, Inc. (U.S.)
2401 Hiller Ridge Road
Johnsburg
Illinois IL
60051

Systech Instruments Ltd
17 Thame Park Business Centre
Wenman Road
Thame
Oxfordshire
OX9 3XA

E: support.usa@systechillinois.com

E: support.uk@systechillinois.com

www.systechillinois.com

Table of Contents

1.0	PREFACE.....	1
1.1	Important.....	2
2.0	INTRODUCTION	3
3.0	WARRANTY	4
3.1	Instrument Warranty.....	4
3.2	Measuring Cells Warranty	4
4.0	ISOLATION VALVE OPERATING ORDER.....	5
5.0	PRINCIPLE OF OPERATION	5
6.0	TECHNICAL SPECIFICATIONS.....	6
7.0	INSTALLATION	9
7.1	Instrument Installation	9
7.2	Gas Installation	10
7.3	Electrical Installation	12
8.0	USING THE INSTRUMENT.....	12
9.0	INSTRUMENT OPERATION.....	13
10.0	CHANGING PROGRAMME CODES	14
10.1	Front Panel Guide	15
10.2	Data Table Programmable Functions.....	16
11.0	PROGRAMME CODES	19
12.0	CALIBRATION	22
12.1	Calibration with Atmospheric Air	22
12.2	Calibration with Certified Gas.....	23
12.3	Automatic Calibration option	24
13.0	USB and RS485 COMMUNICATIONS.....	26
13.1	Installing the USB Driver Software	26
13.2	Installing the COMMS UTILITY SOFTWARE	27
13.3	Determining the installed Comms Port	30
13.4	Running the COMMS Utility Software	32
13.5	Serial Commands For Use with the EC900.....	34
13.6	RS485.....	35
14.0	OPTIONAL FACILITIES.....	36
14.1	Analogue Outputs (Option).....	36
14.2	Alarm Trip (Option).....	36
14.3	Sample Pump (Option).....	37
14.4	Flow Alarm (Option)	37
14.5	Solenoid Shutoffs (Option)	37
14.6	Hydrogen Configuration (Option)	37
14.7	Autocalibration (Option).....	37
14.8	Explosion-Proof Enclosure (Option)	38
14.9	Other Options.....	38
15.0	FAULT MESSAGES/ALARMS	38
16.0	REPLACING THE MEASURING CELL.....	39

16.1	Model 910, 911 & 912	39
16.2	Model 920, 921 & 922	40
16.3	Model 9X3	40
16.4	Resetting the Calibration Range and Life Counter	43
17.0	SPARE PARTS	44
18.0	SERIAL NUMBER SUFFIX DETAILS	46
Appendix 1	Drawing Number 900 176_B	47
Appendix 2	Drawing Number 920 043_B	48
Appendix 3	Drawing Number 900 180_B	49
Appendix 4	Drawing Number ACB-299900	50

Revision History

Issue	Issue Date	Changes	By
1.1	09-05-2008	Current Release Version	Jon Dawson
2.0	18-08-2009	Format changes, updated some drawings	Nick Stuart
4.0	09-08-2010	Updated to the USB comms model	Nick Stuart
4.1	19-08-2010	Added 0-10V output details.	Nick Stuart
4.2	02-06-2011	Added details for mk 6 PCB, also corrected p16.	Nick Stuart
4.3	20-12-2011	Added info regarding Auto Cal initiation. Re: CI 4162 and SPn2# value.	Nick Stuart
4.4	25-04-2012	Clarified "Delay" for alarm settings. Ref CI 4176	Nick Stuart
4.5	24-08-2012	Amended the flowmeter part numbers	Nick Stuart
4.6	15-11-2013	Added Warranty and other information regarding cells. Updated Wall mount dimensions 920 043.	Bryan Cummings
4.7	5-02-2014	ECN 1404s, All RACE™ cell instruments now have dual life displays.	Bryan Cummings
4.8	5-10-2014	Added information for EExd sensor housing	Bryan Cummings
4.9	5-5-2016	Editorial, AR0213	Bryan Cummings

1.0 PREFACE

The EC900 series of oxygen analyzers exist with a number of variations, with different cabinet types and different measuring cells, these variations are covered in this manual.

We are always trying to improve our product, of which this manual is part, so we would greatly appreciate any information you can give us of any difficulties you may encounter with the analyzer or the manual.

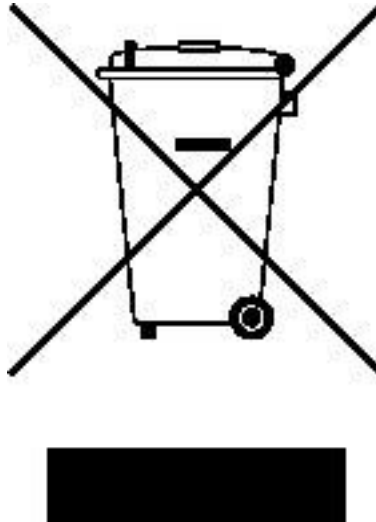

This symbol is known as the 'Crossed-out Wheelie Bin Symbol'. When this symbol is marked on a product it means that consideration should be given to the disposal of the product, parts or accessories. Only discard electrical/electronic items in separate collection schemes which cater for the recovery and recycling of the materials contained within. Your co-operation is vital to ensure the success of these schemes and for the protection of the environment.

1.1 Important

Please read this manual before attempting to install or operate the equipment.

The equipment should be electrically connected and grounded in accordance with good standard practice.

**No responsibility is accepted by Systech Illinois
for accidents resulting from improper use of this equipment.**

All service and technical enquiries are covered from our factories in Thame, Oxfordshire, and Johnsbury, Illinois where we will endeavour to give a quick and helpful response to all queries.

The factory addresses are:

Illinois Instruments, Inc (U.S.)
2401 Hiller Ridge Road,
Johnsbury, IL 60051
Tel: +1 815 344 6212

Systech Instruments Ltd
17 Thame Park Business Centre
Wenman Road
Thame
Oxfordshire
OX9 3XA Tel: +44 (0) 1844 216838

For customers outside UK or USA, please contact us for details of your local representative. Alternatively check out our website:

www.systechillinois.com

2.0 INTRODUCTION

The EC900 Series of instruments may be supplied in three types of cabinet/housing and may use any one of four measuring cells, suitable for different applications.

The instrument may also be fitted with other customer specified options.

Please refer to Table 1 below, for the configuration code and an explanation of the instrument numbering system.

When particular attention should be given in this manual to a particular configuration the paragraph will be preceded with a configuration specification i.e.

EC91x = Panel/Bench mounting

EC92x = Wall mounting

EC9x1 = Trace analysis

Series EC900 Oxygen Analyzers

Cabinet - Mounting	EC9		
Panel or bench mounting		1	
Wall mounting IP66		2	
Rack mounting (*Note 1)		3	
Cell type / range			
% analysis			0
Trace analysis			1
Ultra low trace analysis			2
RACE™			3
Configuration code =	EC9	x	x

Table 1 Configuration codes

* **Note: 1** A rack mounting case is 19" wide, 4U high. This provides a housing suitable for 1 or 2 analyzers.

3.0 WARRANTY

3.1 Instrument Warranty

This Instrument is guaranteed for a period of one year from its delivery to the purchaser covering faulty workmanship and replacement of defective parts. This assumes fair wear and tear and usage specified on the data sheet. It does not cover routine calibration and housekeeping.

Warranty covers parts and labour on a “return to base” basis. Any on-site warranty visits may be chargeable in terms of travel and expenses.

We maintain comprehensive after sales facilities and the instrument should be returned to our factory for repair, servicing or routine calibration if this is necessary. Service agreements are available and can include routine maintenance at the customers site, please contact Systech / Illinois Instruments for more details (support.uk@systechillinois.com or support.usa@systechillinois.com).

The warranty does not extend to sensors overexposed to oxygen during the warranty period, or to those whose elements have been damaged by surges of undue pressure.

The type and serial number of the instrument should always be quoted, together with full details of any fault.

3.2 Measuring Cells Warranty

Please note the Warranty code against the part number of the measuring cell installed by referring to the Spare Parts section.

Code	Warranty	Typical Life and Notes
A	6 Months from the date of supply.	The measuring cell should have a life of 4+ years. The life is very much dependent on the moisture in the gas stream. The more humid the gas (as long as it is non-condensing) the longer the life. The primary reason for premature failure is exposing the cell to air, or to subject the cell to high pressure.
B	12 months from the date of supply.	The measuring cell should have a life of 3+ years. Cells measuring Oxygen concentrations of less than 10% should have a lifetime of 5+ years. The life is very much dependent on the moisture in the gas stream. The more humid the gas (as long as it is non-condensing) the longer the life. The primary reason for premature failure is exposing the cell to high pressure.
C	36 months from the date of supply	The measuring cell should have a life of 5+ years.
D	Cells have a full warranty of 6 months from the date of supply. Between 6 months and 36 months a partial warranty applies.	A credit will be given for complete calendar months remaining up to 36 months. The credit is calculated from $(36 - \text{months in use})/30$. A cell for instance that has failed after 25 months will be credited $(36-25)/30 = 0.366$ * the current list price. The measuring cell should have a life of 4+ years. The life is very much dependent on the moisture in the gas stream. The more humid the gas (as long as it is non-condensing) the longer the life. The primary reason for premature failure is exposing the cell to air, or to subject the cell to high pressure.

WARRANTY EXCLUSION

In some instances cells do not achieve their expected lifetime, failing early due to misuse: isolation valves on the analyser left open causing ingress of high oxygen levels, or cell rupture caused high pressure being applied across the cell. Misuse of the measuring cell in this way is not covered by the warranty.

3.2 Measuring Cells Warranty - continued

NOTE

Most cells that do not last their expected lifetime fail because:-

1. The isolation valves on the analyzer are left open, causing ingress of high ambient oxygen levels.
2. The cell has been ruptured caused by high pressure, usually caused by the isolation valves being operated in the wrong order. Ruptured cells can be confirmed by electrolyte solution seeping from the inlet/outlet pipes or by blackening of the same pipes.

4.0 ISOLATION VALVE OPERATING ORDER.

For analyzers sampling from pressurised supplies:

When opening the cell, open the OUT valve first, followed by the IN valve
When closing, close the IN valve first, followed by the OUT valve.

For analyzer fitted with a pump:

When opening the cell, open the IN valve first, followed by the OUT valve
When closing, close the OUT valve first, followed by the IN valve.

For EC9x3 units which only have one valve on the rear panel:

For analyzers sampling from pressurised supplies:

Ensure the valve is closed. Open the valve sufficiently to have a flow of approximately 50-200 cc/min. Ensure the sample outlet is at atmospheric pressure.

For analyzers fitted with a pump:

Do not connect the sample inlet or outlet to any source of pressure greater than 0.5 BarG. The sample inlet should be connected to an atmospheric pressure source or no less than 0.3BarA. Open the flow valve sufficient to obtain a flow of 50-200 cc/min. Note that the higher the vacuum of the sample inlet pressure it will be more difficult to obtain a high flow.

MISUSE OF THE CELL IS NOT COVERED BY WARRANTY

5.0 PRINCIPLE OF OPERATION

The detector contains an anode, electrolyte and an air cathode to which the diffusion of Oxygen is limited by a diffusion barrier. At the air cathode Oxygen is reduced to Hydroxyl ions which in turn oxidise the metal anode.

The following reaction takes place at the cathode:

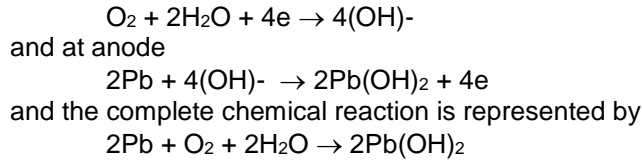

6.0 TECHNICAL SPECIFICATIONS

Measuring Ranges:
(All Auto-ranging)

EC9x0 0.3% - 100%

EC9x1 **EC9x3** 0.1ppm - 30%

EC9x2 0.01ppm - 1%

Calibration Ranges:

EC9x0 0.3% - 100%

EC9x1 **EC9x3** 0.1ppm - 30%

EC9x2 0.01ppm - 1%

Response Time:

EC9x0 **EC9x1** 90% indication in less than 30 seconds

EC9x2 90% indication in less than 30 seconds

EC9x3 Air to less than 20ppm in 2 minutes

Accuracy:

EC9x0 ± 0.2% of calibrated value at 20° C
± 1% of calibrated value over temperature range

EC9x1 **EC9x3** >10ppm
± 2% of reading at 20° C
± 5% of reading over temperature range
<10ppm
± 2% of reading +0.4ppm at 20° C
± 5% of reading + 0.6ppm over temperature range

EC9x2 >10ppm
± 2% of reading at 20° C
± 5% of reading over temperature range
<10ppm
± 2% of reading +0.4ppm at 20° C
± 5% of reading + 0.6ppm over temperature range

Technical Specification contd.

Suitable Gases:

EC9x0	All gases except corrosive gases
EC9x1	All gases except corrosive and/or acidic gases
EC9x2	
EC9x3	

Display:	4 Digit high visibility LED
Sample connections:	1/8" OD compression (Swagelok)
Ambient Temperature:	-5°C to 50°C (Instrument and sample gas)
Sample Gas Inlet Pressure:	3.5 – 29 PSI (0.25 Bar - 2 Bar) Ambient (for pump equipped systems)
Power:	90-260 VAC, 40VA
Area Classification:	General Purpose, except for explosion-proof sensor housing option, see drawing in the rear of the manual.
Communications:	USB 1.0 / 2.0 and RS485
Dimensions:	Refer to the drawing B900 176 at the rear of the manual Appendix 1.

OPTIONS

High / Low Alarms:	Two with volt free c/o contacts fully configurable over the complete oxygen range, one fault alarm. Contact rating 3A @ 250VAC/30VDC
Analogue outputs:	Software configurable over the entire oxygen range for either : Voltage: 0-10VDC isolated Current: 4-20mA isolated Current 0-20mA isolated Option to have three separate channels.
Flow Alarm:	Thermal Mass Flow sensor
Auto Calibration:	Allows connection to a cylinder of gas with a certified level of oxygen. Analyzer will correct to recorded level at programmed intervals.
Bypass Flowmeter:	Improves the response time of the analyzer due to sample transport lag by adding a fast side stream.
Sample Pump	Allows the instrument to be used in situations where there is no pressure to the sample gas.

Stainless Steel Plumbing	Allows the instrument to be used in situations where the sample gas will react with either brass or copper fittings and pipes. Note: stainless steel flowmeter and regulator will also be required.
Explosion-proof (sensor housing)	Allows the mounting of the sensor parts in a certified housing in a hazardous area while the control unit of any type must be mounted in a safe area (can be set up for both pressurized and ambient pressure applications).
Pressure Regulator	For use in applications where the inlet pressure is above 2 bar or there are fluctuations in pressure.
Solenoid Shutoffs	Isolates the analyser at power down.
Hydrogen Configuration	For use in applications where any concentration of hydrogen is present in the sample stream.
Other Options	Particulate filters, Panel Mount brackets, Optional fittings. Please contact Systech / Illinois Instruments for more details.

7.0 INSTALLATION

7.1 Instrument Installation

The instrument is offered in bench/panel mount, IP66 wall mounting or rack mount. Dimensional drawings should be referred to at the rear of the manual.

Please read this manual thoroughly before connecting or applying power to the unit. Systech / Illinois Instruments cannot be responsible for problems arising from improper connection or operation.

Panel mount brackets may be ordered with the bench/panel mount analyzer.

A general view of the Model EC920 weatherproof instrument follows:

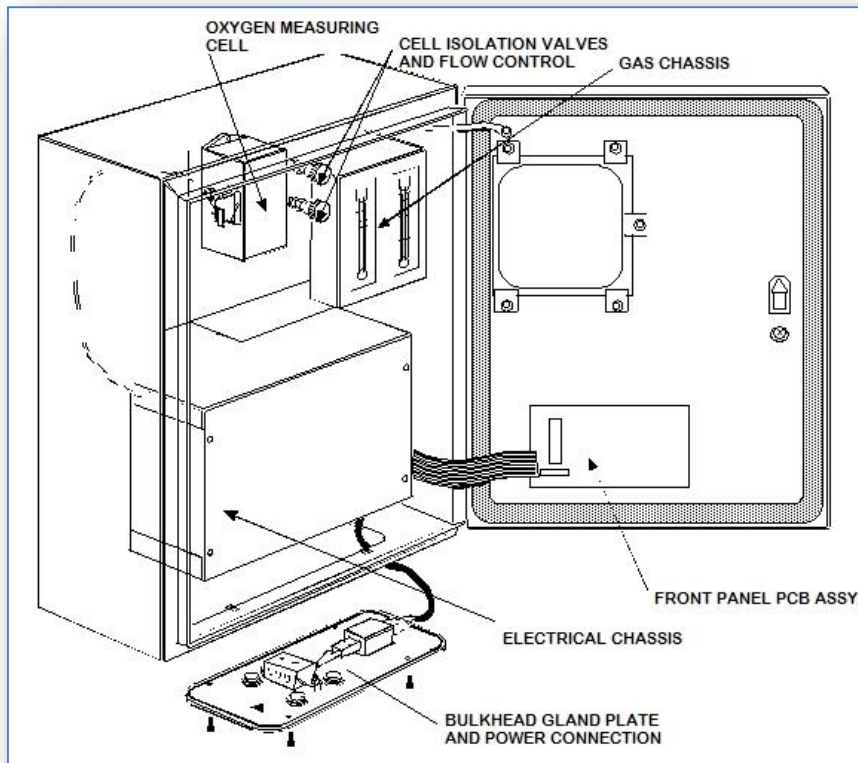

7.2 Gas Installation

The instrument can be used to measure different oxygen concentrations. If the application is the measurement of percent oxygen, then the instrument may be connected with plastic/nylon/ptfe tubing otherwise all fittings and sample lines to the instrument should be high integrity so ensuring no ambient air is allowed to leak into the system.

It is recommended that stainless steel or copper lines be used for the sample inlet.

If a vent line (sample outlet) is fitted then this may be of nylon tubing or similar, but should be installed so that no back pressure may build up due to a restricted outlet.

The inlet and outlet pipe size is 1/8 inch compression (standard).

The two valves on the gas chassis serve to seal off the instrument from the sample and the sample inlet valve will also serve as a flow regulator valve.

Note: Instruments of type 9X3 are fitted with one valve only, see Section 4.0 Isolation Valve Operating Order.

When a pressurised supply of sample gas has been connected to the instrument, the cell outlet valve should be opened fully, and then the sample inlet valve should be opened sufficiently to obtain a desirable flow: approximately 100 - 150ml/min will be adequate.

For analyzers fitted with the pump option, the cell inlet valve should be opened fully and the cell outlet valve opened sufficiently to obtain 100 - 150 ml/min.

Too high a flow rate will pressurise the measuring cell and cause an error in the reading for some time.

Conversely, the instrument should be disconnected from the sample by reversing the above procedures. In other words at no time should the cell be pressurised with the sample inlet pressure, or by the pump. Failure to follow this procedure may result in irreparable damage to the cell.

Important

EC9x1

EC9x2

Sample lines and upstream pressure regulators should be thoroughly purged before connecting to the analyzer. If a bypass flowmeter and adjustment valve has been fitted to the instrument, then the purging can be achieved easily before the isolation valves are opened

EC9x3

This instrument has one valve on the rear panel:

For analyzers sampling from pressurised supplies:

Ensure the valve is closed. Open the valve sufficiently to have a flow of approximately 50-200 cc/min. Ensure the sample outlet is at atmospheric pressure.

For analyzers fitted with a pump:

Do not connect the sample inlet or outlet to any source of pressure greater than 0.5 BarG. The sample inlet should be connected to an atmospheric pressure source or no less than 0.3BarA. Open the flow valve sufficient to obtain a flow of 50-200 cc/min. Note that the higher the vacuum of the sample inlet pressure it will be more difficult to obtain a high flow.

Pressure Regulation

There is no need to regulate the pressure upstream from the analyzer unless it is either above 29psi (2 Bar) or can fluctuate wildly, thereby changing the flow through the instrument. If one is measuring low ppm oxygen and a pressure regulator is necessary, then only a high quality regulator will suffice (see spare parts.)

If however, the pressure of the sample gas is below 3.5psi (0.25 Bar) and is not enough to pass a sample through the analyzer, then a pump will be required and the same comments are applicable as above. Consult Systech / Illinois Instruments for advice.

7.3 Electrical Installation

EC91x

EC93x

The instrument is operated from AC line power, voltage of between 90 and 260 VAC, 50 – 60 Hz. Automatically sensed by the analyzer.

The IEC standard cable supplied should be connected to a captive plug with an integral earth connection and wired to a fused supply, as follows:

Brown to Live
Blue to Neutral
Green/Yellow to Earth

Note that the cartridge also contains a fuse. This fuse must be installed to ensure proper operation of the instrument. It is rated 2A @ 250V, slow-blow type. Replace only with fuses of equivalent ratings.

EC92x

Connect power in accordance with the label on the chassis.

Explosion-proof housing option: make the connections to the control unit using the connector supplied to the back panel. The cable is normally pre-connected to the hazardous area housing and after the conduit is fitted the cable gland should be filled with sealing cement and fibre supplied with the instructions supplied,

DO NOT SWITCH ON UNTIL YOU READ THE NEXT SECTION – USING THE INSTRUMENT

8.0 USING THE INSTRUMENT

Start-Up

1. Ensure the sample gas lines have been connected and purged with the advice given in section 7, Installation.
2. Ensure that the sample pressure is within the specification limits.
3. Ensure the power supplied is correct to the configuration.
4. Apply power. All segments of the LED's on the display will light and then read the software version i.e. C2.18. If there are any faults the display will alternate between a display of oxygen and the fault message. Refer to the Section 15 for explanation of fault messages.

9.0 INSTRUMENT OPERATION



The instrument is controlled through the four digit keypad and the LED display. Control is also possible via the USB communication port. Some parameters can only be set using the USB connection. See the section on Software and the USB port

In measurement mode the instrument displays the oxygen concentration of the sample gas. The display will auto range dependent upon the measured gas with ppm or % indicated by the LED's to the right of the digital display

To access programming mode press the menu button on the 4 digit keypad



The LED above the button will switch on to indicate programming mode and the digital display will indicate the selected function. The menu button is used to scroll through the available parameters. When selected the display briefly shows the parameter name and then displays the current value. If no button is pressed for 5 minutes, the instrument will return to measurement mode.

10.0 CHANGING PROGRAMME CODES

Changing the programme codes in order to set up alarms, analogue outputs or other functions is simple. There are two 'pages' of information.

Page 0 contains all the functions that the user may want to change frequently, such as setting Channel 1 analogue output from 0-100ppm to say 0-10ppm.

Page 1 functions are those which will only need to be set up once on commissioning, such as setting whether the type of analogue output for Channel 1 is 4-20mA or 0-20mA.

Page 1 functions are password protected. The factory default password is 1234.

To enter page 0 functions, as displayed in 'Data Table Programmable Functions',

Press the 'programme' button



The led above it will light and the display will briefly read PAGE, then 0 (to indicate you are in page 0). Press the 'programme' button again and the display will read AL1 briefly then the value. As you can see from the data table what functions are available depend on the type of instrument and the configuration.

Every time the 'programme' button is pressed a new function will be displayed briefly and then the value for that function. Note - some functions are 'read only'.

Continual pressing of the 'programme' button will eventually show -O2- and this signals the end of the Programming mode and the instrument is returned to measurement mode.

To enter page 1 functions,
press the 'programme' button



The display will briefly read PAGE then 0 (to indicate you are in page 0).

Now press



Which is the 'digit select' button, and the display will flash.

Now press the

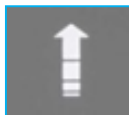

Which is the 'digit Increment' button to change the display from 0 to 1.



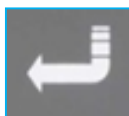

Now press the 'enter' button,

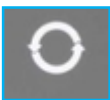

The display will briefly read PAS? And then 4 digits. To access page 1 you must enter a correct password. At this point the display will read 0000 or the last 4 digits entered by another user. The factory set password is 1234 so press the 'enter' button to acknowledge this number. The display will show YES, for a correct password or NO if incorrect. If you have the correct password then you will see functions of the page 1.

Note, to get out of page 1, back to page 0 and then to return to the measurement mode you must keep pressing the programme key until you get to the PAGE function and change the code from 1 to 0 using the method shown above.

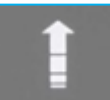
10.1 Front Panel Guide

COMPONENT	FUNCTION	OPERATION
 Program Scroll	Used to scroll through the front panel menu functions.	Press to select the required data. First press displays the function code. After 1 second the data relating to the code is displayed. If the key is pressed before 1 second then the next function code is shown. Continue to press the button until all programme values have been accessed and -O2- is shown when the display will revert to the measurement of oxygen.
 Digit Select	Selects display digit to be changed.	Selection is indicated by flashing digit, first press selects D1 and successive presses select remaining digits, decimal point and % and ppm LED's.
 Digit Increment	Increments selected display digit.	Each press steps selected digit through complete numerical range. Cycles decimal point position. Toggles ppm and % LED's
 Enter/Reset	Enters new data into memory for that function.	Press once to reset the display, after 1 second the display shows STORE to indicate it has accepted the entry (otherwise it will show ERR) or other fault message.
D1 to D4	Displays 0 to 9 and/or decimal point.	Display set by selecting appropriate digit, then digit increment.
PGM LED	When on, indicates instrument in program mode.	
ALARM 1 LED	Indicates Alarm 1 status.	Illuminated indicates Relay 1 de-energised and in alarm condition.
ALARM 2 LED	Indicates Alarm 2 status.	Illuminated indicates Relay 2 de-energised and in alarm condition.
FAULT LED	Indicates fault alarm status.	Illuminated indicates fault relay energised and in alarm condition.
%	Displayed measured value is % oxygen by volume.	
ppm	Displayed measured value is parts per million by volume.	

10.2 Data Table Programmable Functions

There are two pages of programme functions. Page 0 are functions that the operator may want to change frequently, for example alarm trip levels and analogue output scales. Page 1 functions require a password to enter and have been arranged so that they will normally only require to be set up on commissioning.

A full description of the Programme Codes can be found in Section 11.

10.2.1 PAGE 0 Functions

DISPLAY	FUNCTION
PAGE	Can be 0 or 1 indicating which page to move to.
AL1*	Sets the numerical value for the first alarm point and % or ppm.
AL2*	Sets the numerical value for the second alarm point and % or ppm.
OPH1*	Sets the analogue output high value for ch. 1
OPL1*	Sets the analogue output low value for ch.1
OPH2*	Sets the analogue output high value for ch. 2
OPL2*	Sets the analogue output low value for ch.2
OPH3*	Sets the analogue output high value for ch. 3
OPL3*	Sets the analogue output low value for ch.3
SPn1 #	Shows read only value of span for cell 1 (ppm) normal value is approximately 0.280
SPn2 #	Shows read only value of span for cell 2 (%) normal value is approximately 0.3
SPHi EC9x3	Adjusts the calibration high point to the correct value to agree with the plant gas, air or certification cylinder. The gas should be in the range 1%-25%.
SPLo EC9x3	Adjusts the calibration low point to the correct value to agree with the plant gas, air or certification cylinder. The gas should be in the range of 10-1000ppm.
CAL EC9x0 EC9x1 EC9x2	Sets the calibration of the analyzer to the correct value for a known sample gas, plant gas, air or certified cylinder.
ACAL*	Sets the O ₂ value for the autocalibrate function.
LIFEL	For all RACE™ cells, this shows the remaining PPM cell lifetime as a percentage.
LIFEH	For all RACE™ cells this shows the remaining % cell lifetime as a percentage.
-O2-	Final message before the instrument reverts back to oxygen measurement.

* These functions will only be displayed and operable if the option has been purchased.

should you require assistance from a Systech / Illinois Engineer, please note these values for diagnostic purposes.

10.2.2 PAGE 1 Functions

DISPLAY	FUNCTION
OL*	Sets the configuration of alarm 1 and alarm 2, i.e. high/low, low/high, low/low or high/high. Also sets whether the alarms are latched or unlatched.
ALHLD*	Should the instrument be configured with alarms and automatic calibration then with this function a hold can be set on the alarms for the duration of the autocal and for a further five minutes until the process settles down to equilibrium.
ANHLD*	Should the instrument be configured with analogue outputs and automatic calibration then with this function a hold can be set on the analogue outputs for the duration of the autocal and for a further five minutes until the process settles down to equilibrium.
ANCH1*	Sets the configuration of the Analogue output for channel 1. Can be 0 = 4-20mA, 1= 0-20mA or 2=0-10V.
ANCH2*	Sets the configuration of the Analogue output for channel 2. Can be 0 = 4-20mA, 1= 0-20mA or 2=0-10V.
ANCH3*	Sets the configuration of the Analogue output for channel 3. Can be 0 = 4-20mA, 1= 0-20mA or 2=0-10V.
GAS	Sets the molecular weight of the carrier (background) gas.
FLOAL*	Sets the flow in cc/min below which the instrument will trigger a fault alarm.
Acd*	Sets the automatic unattended delay time for the autocalibrate function. A display of 0 shows the feature is switched off. Units are hours.
PASS	Sets the password to enter Page1 of the menu. Factory delivered 1234. It is recommended that if changed a note is made.
PAGE	Can be 0 or 1 indicating which page to move to.
PUnP	Switches on or off the internal pump. 0 = OFF, 1 = ON

* These functions will only be displayed and operable if the option has been purchased.

11.0 PROGRAMME CODES

OL This function returns a two digit code to read and set up the alarm configuration.

The left-hand digit sets whether alarms are high or low. See table below.

DIGIT 1	FUNCTION	
	ALARM 1	ALARM 2
0	Low	Low
1	High	Low
2	Low	High
3	High	High

The right hand digit sets up whether the alarms are latched or unlatched.

DIGIT 2	FUNCTION	
	ALARM 1	ALARM 2
0	Unlatched	Unlatched
1	Latched	Unlatched
2	Unlatched	Latched
3	Latched	Latched

With unlatched alarms, the relay and LED will only change over for the duration of the alarm condition. For unattended operation it may be required for the operator to know that the analyzer had seen an alarm condition, even though the measured value was now normal. Latched alarms remain on until manually or remotely reset. When an alarm is set to Latched the LED will be on when in alarm condition, should the measured value go into a non-alarm condition, then the LED will flash to show that it had been in an alarm condition. (Note: the contacts on the relay will remain switched). Simply pressing the ENTER button will reset the alarm assuming the oxygen concentration has returned to a non-alarm condition. Also can be remotely reset using a USB Comms command.

Alarm relays are energized in the normal (non-alarm) condition and will change state upon the alarms condition being met or by removing power from the analyzer.

OPHx Where x=1, 2, or 3. The level of oxygen corresponding to the maximum level of the analogue output may be set in this mode. However, certain restrictions apply to different configurations.

EC9x0	not less than 1%
EC9x1	EC9x3
EC9x2	not less than 10ppm.
EC9x2	not less than 1ppm.

ACD If the auto-calibrate option is fitted, every x hours the calibration gas will automatically be fed to the measuring cell and after a few minutes the analyzer will self calibrate. ACD is set in hours. Auto calibrating on a weekly basis would mean an Acd of 168 hours. A setting of 0 turns the feature off.

LIFE The value shown is an approximation of the operational lifetime left in the cell in percent. A figure of 50 would mean that half of the life of the cell had been used. If the instrument was in service for 2 years, then the cell would last for approximately another 2 years. For RACE™ type instruments which utilise two measuring cells LIFE_L shows the remaining life of the ppm cell and LIFE_H shows the life of the % cell.

GAS With some configurations the balance/background gas will have an effect on the calibration of the analyzer. An instrument set up correctly to measure oxygen in nitrogen will not read correctly on oxygen in argon. This calibration factor is due to the molecular weight of the background gas. Setting and changing the gas factor to the correct molecular weight for the background gas will always make the analyzer read correctly. The table below gives some common molecular weights; other gas molecular weights can be found from reference books.

GAS	MOLECULAR WEIGHT
Nitrogen	28.02
Argon	39.91
Helium	4.0
Hydrogen	2.02
Sulphur Hexafluoride	146.0
Ethane	30.07
Ethylene	28.05
Propane	44.0
Methane	16.04

Gas mixture molecular weights can be ascertained by a direct relationship, i.e. a gas background of 60% helium and 40% argon will be $(0.6 \times 4.0) + (0.4 \times 39.91) = 2.4 + 15.96 = 18.36$

ANCHx The analogue outputs are software configurable and the can be set for Voltage 0-10Volts, Current loop, 4-20mA or 0-20mA.

Set the output to the table below:

Note that each output is independent and can be set for any output type.

DIGIT	OUTPUT TYPE
0	4-20mA
1	0-20mA
2	0-10 Volts

PASS Used to enter into Page 1 of the programme menu. Here is where all the parameters for commissioning will be set.

The factory configuration password is 1234. Be sure to make a note should you want to change the password.

Should the password be lost then the password 1111 will always gain entry.

ALHLD Should the instrument be configured with alarms and automatic calibration then with this function the alarms can be suppressed for the duration of the autocal and for a further five minutes until the process settles down to equilibrium.

To turn the feature on change the code from 0 to 1. Factory configuration is 0 (off).

ANHLD Should the instrument be configured with analogue outputs and automatic calibration then with this function the analogue outputs can be suppressed for the duration of the autocal and for a further five minutes until the process settles down to equilibrium.

To turn the feature on change the code from 0 to 1. Factory configuration is 0 (off).

12.0 CALIBRATION



Calibration should be carried out using a gas which is in the same range as the gas that is being analysed.

For applications in the percentage range, the calibration may be carried out using atmospheric air.



12.1 Calibration with Atmospheric Air

EC9x0

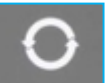
EC9x1

1. Set up the instrument such that atmospheric air is circulating through the instrument, either with a pump or compressed air. Make sure the pressure is the same as the sample gas.
2. Enter the set-up mode by pressing  on the front panel of the instrument.
3. Once in the CAL mode the default value is 20.9%
4. Enter the CAL mode by pressing 
5. By pressing the ENTER button the instrument will automatically reset itself to 20.9% and continue to measure the oxygen content of the air
6. Continue pressing  to return to oxygen measurement. See Front Panel Guide

EC9x3

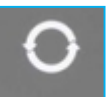
1. Set up the instrument such that atmospheric air is circulating through the instrument, either with a pump or compressed air. Make sure the pressure is the same as the sample gas
2. Enter the set-up mode by pressing  on the front panel of the instrument
3. Once in the SPH1 mode the default value is 20.9%
4. Enter the CAL mode by pressing 
5. By pressing ENTER the instrument will automatically reset itself to 20.9% and continue to measure the oxygen content of the air
6. Continue pressing  to return to oxygen measurement. See Front Panel Guide

12.2 Calibration with Certified Gas

EC9x0

EC9x1

EC9x2

1 Connect the certified gas to the sample port ensuring the same pressure as the sample gas, in order to obtain the same flow rate as the sample gas, allow the reading to stabilise.

2 Enter the SET-UP mode by pressing



3 Change the CAL value from the default to the value printed on the certification label on the cylinder, making sure you have changed the %/ppm LED, if appropriate

4 Pressing the ENTER button



will force the display to the value set for the certified bottle.

5 Continue pressing



To return to oxygen measurement. See Front Panel Guide.

Note:- If the CAL value is correct press



then press



to calibrate at that level

EC9x3

1 Connect the certified gas to the sample port ensuring the same pressure as the sample gas, in order to obtain the same flow rate as the sample gas, allow the reading to stabilise

2 Enter the SET-UP mode by pressing the programme button



on the front panel of the instrument

3 If the certified gas is above 2,000ppm enter the value in SPHi. If it is below 2,000ppm enter the value in SPLo, making sure you have changed the %/ppm LED, if appropriate

4 Pressing the ENTER button



will force the display to the value set for the certified bottle

5 Continue pressing the

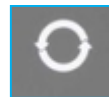

button to return to oxygen measurement. See Front Panel Guide

Note:- If the CAL value is correct press



then press



to calibrate at that level.

12.3 Automatic Calibration option

Automatic calibration can be initiated in two different ways. Either automatically after a pre-determined interval, or initiated by a control signal.

1. Connect the certified gas to the 'cal gas' connection on the rear panel of the analyzer or appropriate valve connection if using remote Autocal. Ensure the pressure is set to the same pressure as the sample gas to obtain the same flow rate.
2. Set ACAL in the main menu to the oxygen value of the certified gas.
3. Set Acd in the main menu to the desired interval, in hours, for Auto-calibration. If Auto-calibration is to be initiated via a control signal then Acd should be set to zero.
4. To initiate Auto-calibration from a control signal. Referring to the diagram below, the connection on pin 17 should be shorted to ground momentarily.

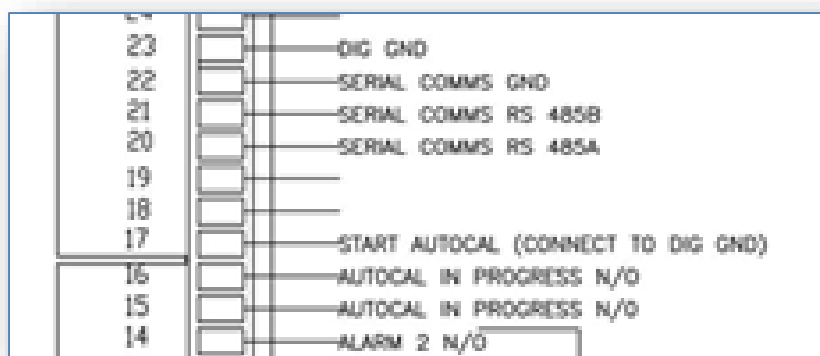

A control signal provided by two volt free relay contacts on the rear of the instrument is available to indicate that there is an Auto-calibration in progress. This is between connections on 15 and 16. These will be a short circuit while Cal is in progress.

When automatic calibration is activated the instrument will sample the certified gas for 30 minutes before performing the calibration. During this time the display will read the currently measured value of the certified gas.

The settling time can be modified via the USB connection using the command CALTIM= (See section 13.5, USB Comms Port).

Following auto-calibration a fault alarm will appear if the measured value of oxygen does not achieve a certain band around the ACAL value within the settling time allowed. The acceptable band can also be modified using USB comms with the command CALBAND=x, where x=0 to 999 (default 100) expressed as a percentage of the ACAL value.

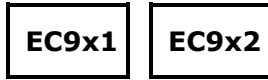
NOTE

Great care should be taken not to allow air to enter the analyzer. If the certified gas contains low ppm levels and air has entered the system, it could take several hours for the oxygen value to equilibrate.

The instrument will only tolerate a certain level of adjustment. If the analyzer reads 49ppm and the certified bottle is 12.6ppm, the analyzer will reject the input of a value of 12.6ppm because it considers the error to be too large. Something else is almost certain to be incorrect. Ensure the sample from the bottle is at equilibrium and there are no leaks in the connection from the certified gas cylinder to the instrument. It will take many minutes, even hours, to sweep all the air out of the pressure regulator and sample lines connected to a cylinder of a few ppm oxygen.

13.0 USB and RS485 COMMUNICATIONS

The USB port is a bi-directional high speed communications port which allows operator intervention via a communication utility called Systech_Illinois_Client Utility. This communication utility is included on the Memory Stick supplied with the analyzer. Also supplied is a USB data connection cable.

If you do not have the Memory stick, the software can be downloaded from our website, please contact Systech / Illinois Instruments at support.UK@systechillinois.com or support.USA@systechillinois.com to obtain the required customer log in details. The USB data communication cable is standard USB A to USB B cable.

However before the USB cable is plugged into your PC you **MUST** install the necessary driver software. This is again available on the Memory Stick supplied and is called CDM20600.exe

13.1 Installing the USB Driver Software

Open Memory stick using your computers explorer and double click on autorun.exe. From the memory Stick distribution screen (below); click on USB Driver Software as shown below:-

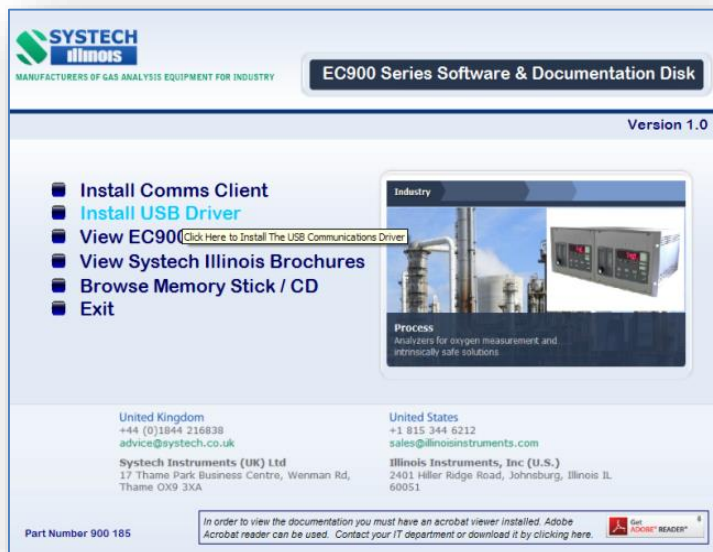

You will then be presented with the following screen. Click on the “USB Driver Software Button” and you will be presented with a window similar to the one shown here.

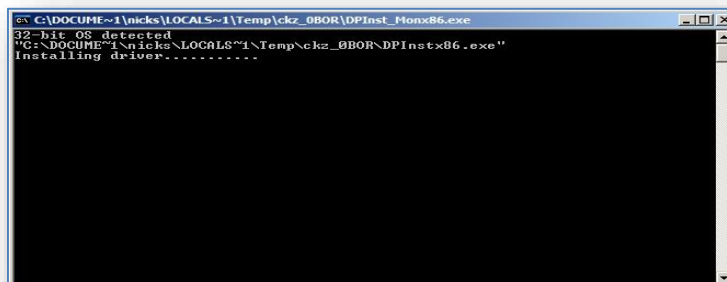

When the driver software has installed the above window will close and you will be back at the driver installation screen. Click on “Return” and continue with the next section.

13.2 Installing the COMMS UTILITY SOFTWARE

From the memory Stick distribution screen (below); click on Install Comms Client as shown below:-



The installation program then starts with the following screen:-

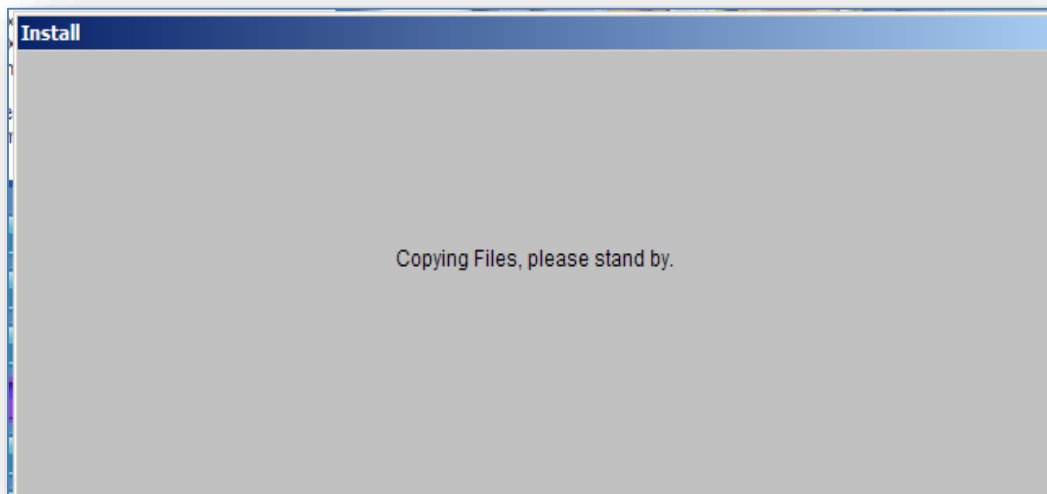

After a short amount of time the following screen is displayed:-

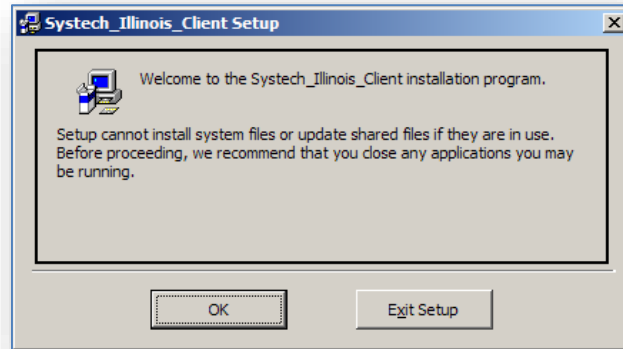

Click on OK, then the screen will change to this:-

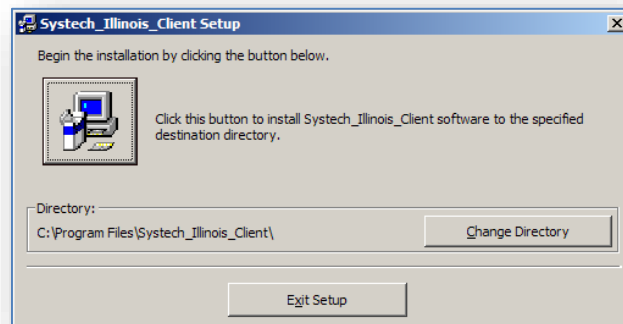

Click on the button shown above to install the Comms Utility software to the specified destination directory. You can at this point select a different folder; however Systech Illinois do not recommend this. You will then be presented with the following screen:-

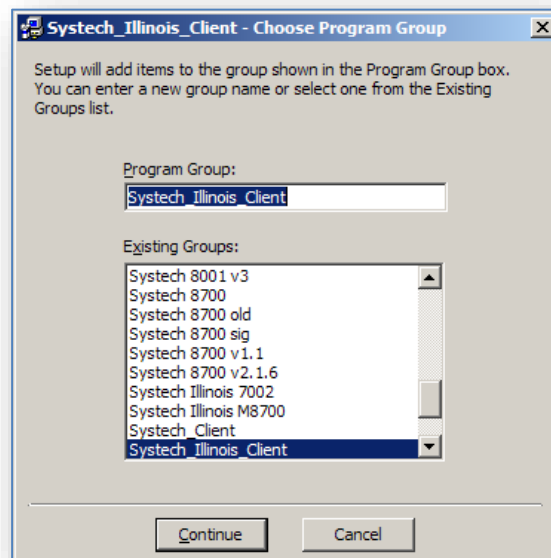

This screen allows you to select or change the program group, Systech Illinois recommends that at this point you accept the default setting and click on Continue.

Now the software will commence its installation process with the following screen:-

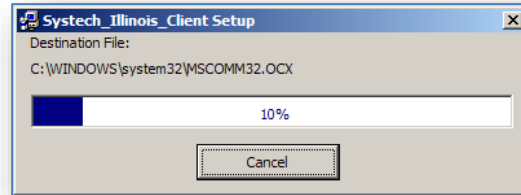

The blue bar shown indicates the installation progress. When it has reached 100% (which only takes a few minutes) you will be presented with this screen, which indicates that the software has been installed satisfactorily.

If during the installation phase you are presented with a screen that informs you that you are trying to replace a file on your computer with one that is an older version than the one you have, always keep the newer file.

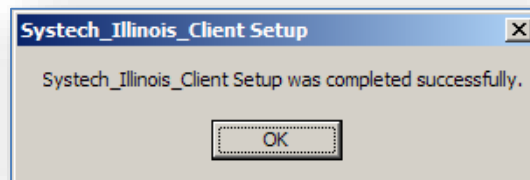

Creating a Desktop Icon

If you wish to have an icon on the desktop to click in order to start the Systech_Illinois_Client follow the following steps:-

Go to "Start", "All Programs", "Systech_Illinois_Client", and right click on Systech_Illinois_Client. Next click on "Send to" and then click on "Desktop (create shortcut)" as shown below. There will then be an icon placed on your desktop to invoke the Systech_Illinois_Client program

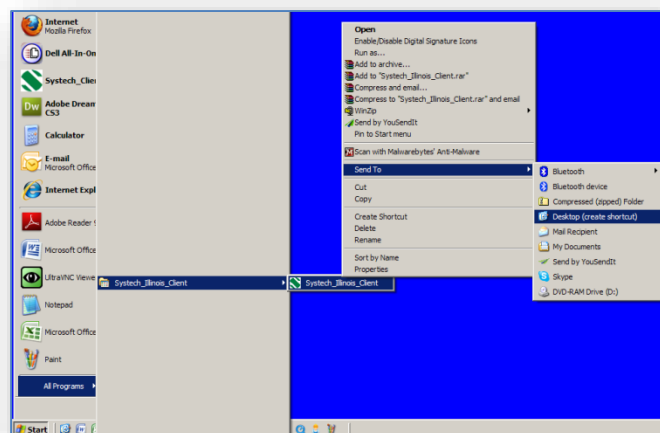

13.3 Determining the installed Comms Port.

When running the software for the first time you need to determine what the comms port is that has been assigned to the instrument. Note for multiple instruments connected simultaneously each will have a different comms port allocation. In addition to this you should bear in mind that Comms Utility can only access up to Com 6.

Ensure that the supplied or similar USB Cable is connected between the Computer and the analyzer.

1. Click on “Start”, “Control Panel” and “System” you should be presented with the following screen.

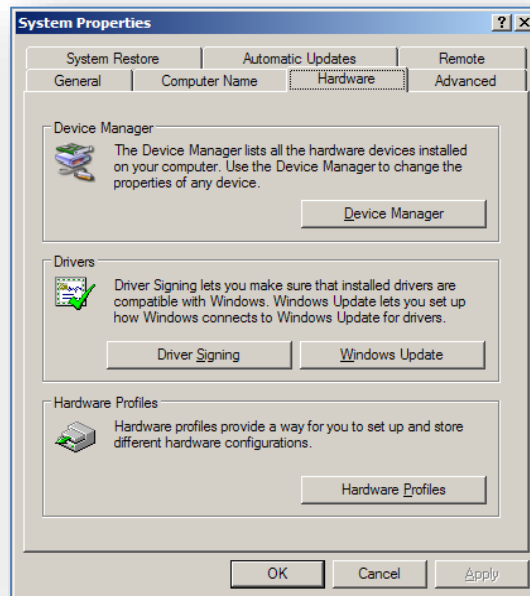

2. Click on “Hardware” and “Device Manager” again you should see a screen similar to this.

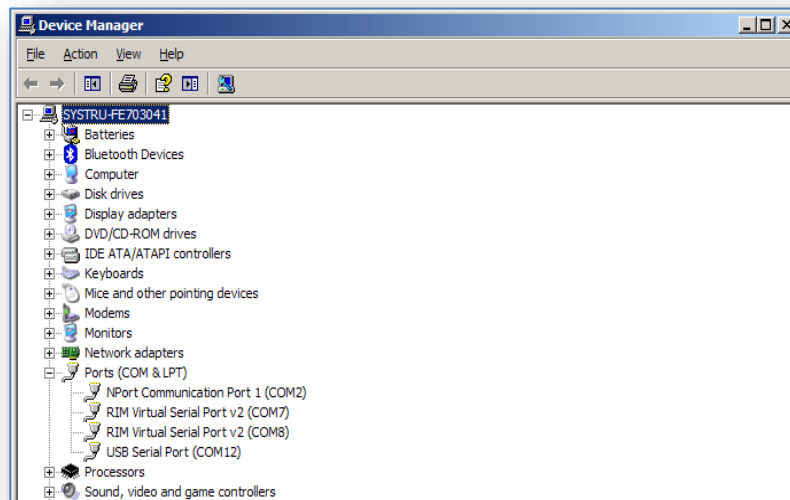

Expand out the “Ports” section and you will see an entry for “USB Serial Port” this is the 900 Series analyzer. You will note that in the illustration above it has been installed as Com12. This is not suitable for Systech_Illinois_Client as it is above Com6.

To change this Port number, Double click on “USB Serial Port”, you should be presented with the following screen.

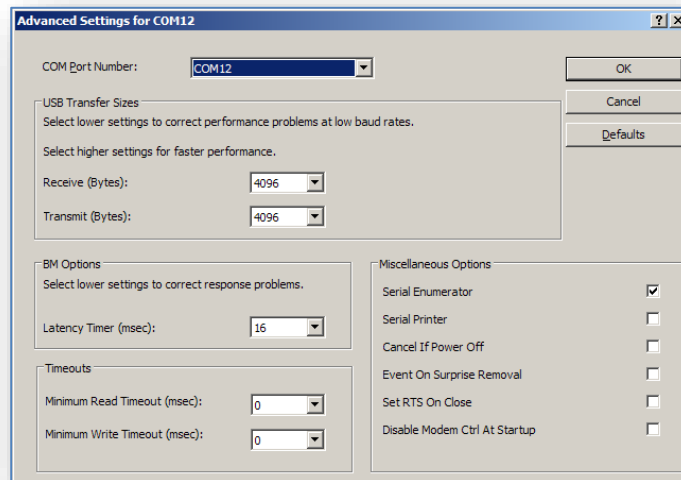

Click on the downward arrow next to COM12, and you will get a drop down list of all in-use and available ports. As shown here.

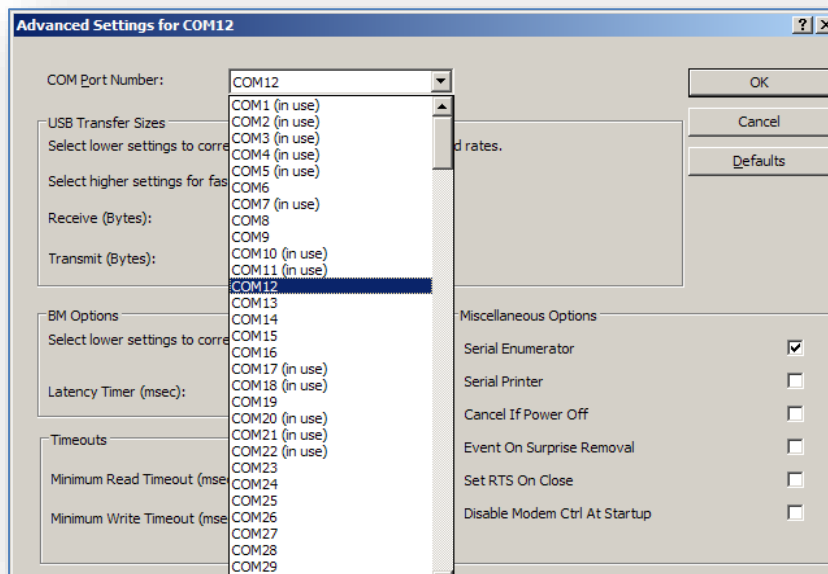

In this instance I know that Com1 is the only physical port installed and in use on the test PC. I will move the USB Serial Port to Com2; this will be achieved by clicking on the list above on Com2. Then Click on OK. You should (if the port is in use) get the following message.

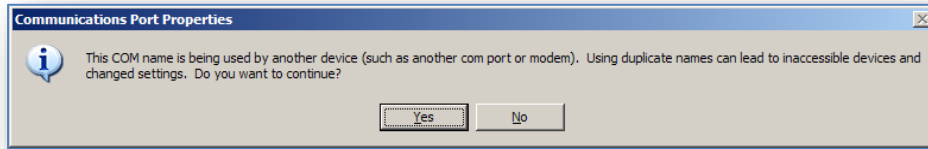

Click on “Yes”, and then OK, then OK again, finally close the “Device Manager” and “Control Panel”. The comms port used by the 900 series Instrument will now be set to Com2.

If multiple Instruments are to be connected simultaneously then you will have to assign a comm. Port in range Com 1 to 8 for each unit. NOTE: you can only attach 8 instruments simultaneously to the PC, and operate / interrogate them with Systech_Illinois_Client.

13.4 Running the COMMS Utility Software.

Ensure that the supplied or similar USB Cable is connected between the Computer and the Systech Illinois Analyzer. Using the computers Device manager, note which COMMS port is being used for the USB connection, Note it MUST be between Com1 and Com8, if it is not within this range please contact Systech / Illinois for details on how to change the com port.

To Run Systech_Illinois_Client either use the SHORTCUT on the desktop or run from the START\PROGRAMS\Systech_Illinois_Client Menu.

When the Systech Illinois Comms Utility window is open you should see the following box.

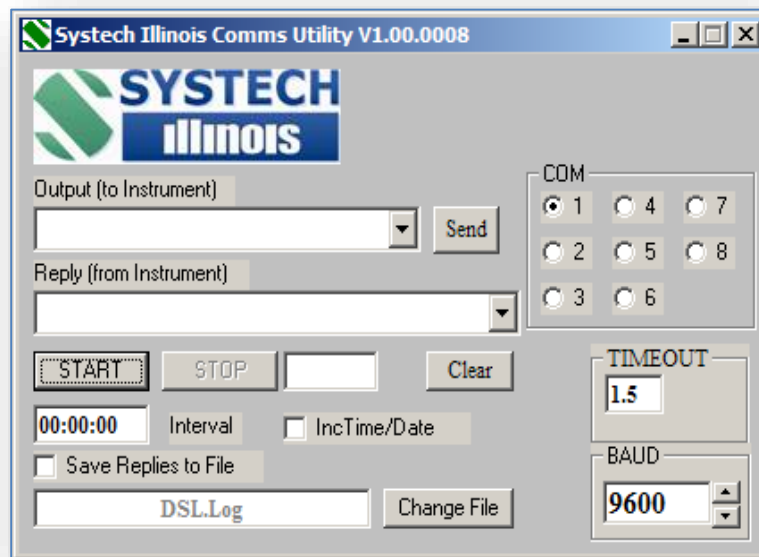

First select to which port the analyzer is connected; e.g. COM 1

Type in the correct command from the analyser commands list in the **OUTPUT (to instrument)** window; and hit return or click on Send. If communications is OK then an answer is shown as a **REPLY (from instrument)** otherwise “TIMEOUT” or a “?” is shown.

Should “?” be shown in the reply window it means that the instrument does not understand the question. Should a “TIMEOUT” be shown in the reply it means that communications are not

established between the PC and the instrument, perhaps due to an incorrect Comms port selection, a faulty Comms cable or some other fault.

To repeat the same command at regular intervals enter frequency of repeat interrogations in the **Interval** window. Note the format is hh:mm:ss

If required, check the **SAVE REPLIES TO FILE** box; enter a filename by either typing over DSL.Log or click on **CHANGE FILE** to select another.

Check the **INC TIME/DATE** box if you wish to save the time and date with each REPLY in the file to be saved.

Click on Start to begin interrogation of the instrument; click on Stop to end the interrogation.

Remember: - Only use the Commands on the analyzer that are listed. Other commands not listed may make changes to the analyzer that may necessitate return for non-warranty corrections or repair.

13.5 Serial Commands For Use with the EC900

COMMAND		DESCRIPTION
?		Reads measured O ₂ value
VER?		Reads Version no.
TEMP?		Reads cell temperature
SERNO?		Reads instrument serial no.
LIFE?X		Reads cell life, X=1 for ppm cell, X=2 for % cell
CELL?		Reads cell type (0= RACE cell, 1 = ppm cell, 2 = % cell)
SAVESPAN=X		Saves SPAN values and resets LIFE to 100%, X= 1 for the ppm cell, X=2 for the % cell.
UNLATCH		Resets the alarm latch.
AL1?	AL1=	Reads/Sets Alarm1 set point
AL2?	AL2=	Reads/Sets Alarm2 set point
ID?	ID=	Reads/Sets instrument ID no. (0 to 9)
ANHI?1	ANHI=1_	Reads/Sets oxygen level for high analogue output 1 (20mA)
ANLO?1	ANLO=1_	Reads/Sets oxygen level for low analogue output 1 (4mA)
OL?	OL=	Sets OL parameter
ACAL?	ACAL=	Reads/Sets O ₂ value of calibration gas
ACD?	ACD=	Reads/Sets interval for Autocalibration (hours)
GAS?	GAS=	Reads/Sets carrier gas molecular weight
CALTIM?	CALTIM=	Reads/Sets settling time
CALBAND?	CALBAND=	Reads/Sets the band around the ACAL value
MFLO?		Reads the flow through the sample line when Flow Alarm option has been purchased

Note: For commands which return or require an oxygen value then scientific notation, with 1 = 100% should be used. For example:

100% would be 1E-00
 20.9% would be 2.09E-01
 0.1% (1000 ppm) would be 1.0E-03
 35 ppm would be 3.5E-05
 2 ppm would be 2.0E-06

13.6 RS485

RS485 communications is available simultaneously with the USB connection. There are no user selectable links that need to be changed within the instrument, all that needs to be done is to allocate an address and connect the RS485 to the instrument. The connection details are below.

Data cables should be connected to the terminal strip on the rear panel refer to drawing no. B900 076 at the end of this manual:

Terminal	Signal
A	Data +
B	Data -

To communicate with the instrument an instrument address should precede the normal USB command. Default address is 9 so sending #9'command' and the instrument will return the data, i.e. #9? carriage return will return the oxygen reading.

If there is more than one instrument connected, the instrument ID should be different for each. To set the address connect only one instrument to the RS485 and send "#9ID=x" where x = 0 to 9. It is also possible to set the instrument address using USB.

14.0 OPTIONAL FACILITIES

Series EC910 & EC930 Connections

See Drawings B 900 150A
B 900 162A.

Series EC920 Connections

See Drawing B 920 037 A

14.1 Analogue Outputs (Option)

The analogue output option provides one or three outputs, each configurable for 0-10V, 4-20mA or 0-20mA (isolated) for connection to a chart recorder, computer or other device for tracking the response of the analyzer. These signals are available at the connector on the rear panel, as labelled.

The current output (4-20mA) can drive a load of up to 500 Ohms. The voltage and current outputs may also be used simultaneously if the three channel option has been purchased so that more than one device may be driven by the analyzer.

The user may set the analogue output high and low values according to their needs by modifying OPH (output high) and OPL (output low). See section 10.2.1 Page 0 Functions for more information.

For example:

By setting OPH to 2.5% and OPL to 1%, the 10V signal is assigned to 2.5% oxygen and 0V to 1% oxygen. Likewise, the 20mA signal indicates 2.5% and 4mA is 1%. As the oxygen varies between 1 and 2.5%, the voltage and current signals will also vary. If connected to a computer then these signals can be used to trigger an alarm message based on the voltage or current level (which corresponds directly to the oxygen level).

NOTE Analogue outputs are an option which must be ordered at the time of initial purchase. If they need to be retrofitted to an existing EC900 series instrument, it must be returned to Systech / Illinois for processing.

14.2 Alarm Trip (Option)

There are two volt free alarm contacts, rated 5A/240V. Both have normally open and normally closed contacts and reference should be made to the connection diagram at the rear of this manual. The contacts are designated normally open and normally closed under normal alarm free operation, power on.

Please note that should a latched alarm position be set, the relay will not change back until it is reset, assuming the measured value has reverted back to a non-alarm value.

Alarm relays are energized in the non-alarm condition and will change state upon the alarm condition being met or by removing power to the analyzer.

14.3 Sample Pump (Option)

Please note that the optional sample pump allows ambient oxygen to permeate through the pump diaphragm thereby contaminating a closed loop system with ambient concentrations of oxygen. To avoid this situation, it is best to route the exhaust to a vent or to atmosphere rather than back into the system from which the analyzer is drawing. In non-closed loop systems this is not a problem as the pump is located downstream of the sensor.

Pumps are left in the off position by default when they leave the factory and will need to be turned on after installation. Please refer to section 10.2.2 Page 1 Functions for information about turning the pump on or off.

Please refer to section 4.0 Isolation Valve Operating Order for guidance on how to open or close valves properly to prevent damage to the sensor(s) when turning on the pump.

14.4 Flow Alarm (Option)

This option incorporates a mass flow sensor in the Sample System which triggers a fault condition whenever flow drops below the set point. This set point can be changed in the menu system or through the Client software provided with the instrument. Please see section 10.2.2 Page 1 Functions or section 13.5 Serial Commands for Use with the EC900 for more information.

14.5 Solenoid Shutoffs (Option)

This option isolates the sensor(s) in the event of a loss of power. It places two shutoff solenoids in the sample pathway, one before the sensor(s) and one after the sensor(s).

14.6 Hydrogen Configuration (Option)

If your application contains the presence of hydrogen in the sample stream, then this option should be requested to ensure accurate readings.

Using this option in the absence of hydrogen will not present any problems and there is no charge for the hydrogen configuration option initially. But the replacement sensors are about 1.5% more than the standard sensors.

14.7 Autocalibration (Option)

Allows connection to a cylinder of gas with a certified level of oxygen. Analyzer will correct to recorded level at programmed intervals. See sections 10.2.1 and 10.2.2 for menu information, section 11 for Programme codes, and section 13.5 for serial command information.

14.8 Explosion-Proof Enclosure (Option)

Allows the mounting of the sensor parts in a certified housing in a hazardous area while the control unit of any type must be mounted in a safe area (can be set up for both pressurized and ambient pressure applications).

14.9 Other Options

There are many other options for customizing your EC900 such as adding a bypass to improve response time, a pressure regulator for applications above 2 bar or for fluctuating sample pressures as well as a number of other plumbing options including stainless steel plumbing or various different fittings for connection to sample lines. Particulate filters and Panel Mount brackets may be purchased as well. Please contact your sales representative or email sales.UK@systechillinois.com or sales.USA@systechillinois.com for more information.

15.0 FAULT MESSAGES/ALARMS

Certain messages may appear on the LED display of the analyzer, either in operation of the analyzer or during programming.

Code	Description
'F-th'	Thermistor open circuit, most likely cause may be the cell at the rear of the instrument has become disconnected.
'FLO'	If a flow alarm has been fitted, then a FLO error indicates a flow failure.
'Err'	When programming new values this display may appear. It indicates the user is attempting to program a number or value outside a permitted range.
'Cant'	When programming new values this display may appear. It indicates the user is attempting to program a number or value outside a permitted range.
'ACAL'	Automatic calibration fault – indicates an oxygen value outside limits (set under USB) when Autocal attempted. Requires successful calibration to clear
'CELL'	Indicates cell life below 20% and the need to replace the sensor. Note: Life indicator LIFEL and or LIFEH updates during calibration.

It is possible to delay the operation of the fault relay contacts following detection of an alarm condition. The LED display will indicate the fault but the fault relay contacts will only operate following the selected delay time. This feature can prevent spurious machine stoppages by confirming the fault exists before operating the relay.

The USB comms command DELAY = x (where x=0 to 255 in seconds), sets the delay time. NB Default value is 0.

16.0 REPLACING THE MEASURING CELL

16.1 Model 910, 911 & 912

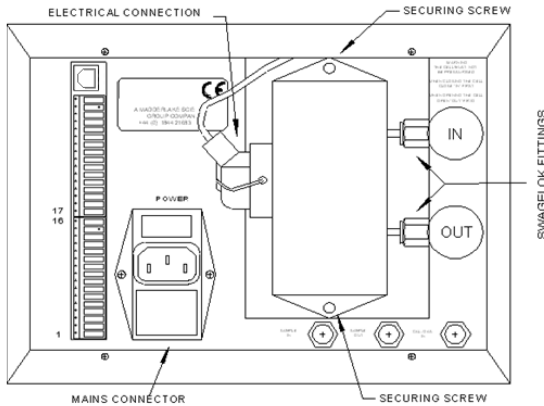

- 1) Switch off the analyzer at the rear panel switch and remove the mains connector.
- 2) Fully close the sample IN valve on the rear panel, and then fully close the sample OUT valve. (N.B. This sequence is required in order to avoid pressurising the cell. When recommissioning; fully open the OUT valve before opening the IN valve to obtain the desired flow). See section 4.0 Isolation Valve Operating Order.
- 3) Remove the 'd' type electrical connection from the cell body.
- 4) Using a 7/16" spanner slacken the Swagelok fittings connecting the cell's sample lines to the flow control valves.
- 5) Remove the two Posidrive screws from the top and bottom of the cell.
- 6) Slide the cell assembly to the left (seen from the rear of the instrument) to disconnect the sample lines, and withdraw the cell from the instrument.
- 7) Position the replacement cell in the instrument and loosely locate the two mounting screws. Do not tighten the mounting screws.
- 8) Slide the cell to the right ensuring the sample lines locate with the Swagelok fittings. Tighten the Swagelok fittings to finger tight and then tighten slightly with a spanner.
- 9) Fully tighten the two mounting screws.
- 10) Reconnect the 'd' type electrical connection to the cell body.
- 11) (A) For pressurised systems fully open the OUT valve, then open the IN valve to set the required flow rate. (B) For systems with supplied with a pump fully open the IN valve and then open the OUT valve to set the desired flow.
- 12) Reconnect the power supply. You will need to recalibrate the instrument after each sensor replacement. See section 12.0 Calibration.

16.2 Model 920, 921 & 922

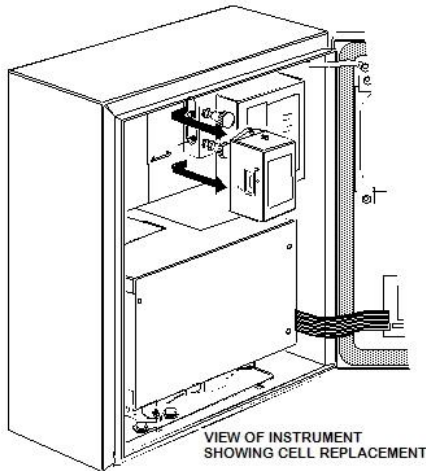

Follow the same procedure as in 16.1 above. The only difference is the mechanical construction of the Wall mount case compared to the panel/bench mount case.

16.3 Model 9X3

RACE™ cell instruments are patented measuring cells that can exist in two constructions:

- Single RACE™ cell where the one enclosure contains two measuring cells (ppm and the % cell). Single RACE™ cell instruments can be identified by virtue that they are marked with Part Numbers 900 055 or 900 059. Replacement of these cells may be the same procedure as in 16.1 above or 16.2 above depending on the housing style.
- Dual RACE™ cell instruments where each cell is an individual cell. These type of instruments can be identified by the fact that they have just one flow valve on the rear panel instead of two, as can be shown in the picture below.



Dual RACE™ cell instruments have the ppm measuring cell on the rear of the back panel and the % cell is mounted inside the instrument.

How do I know which cell has failed?

LIFEL shows the remaining life of the ppm cell and LIFEH will show the remaining life of the % cell. Failure to calibrate the instrument on a ppm certified gas AND a LIFEL figure lower than 40% indicates that the ppm cell has failed. Failure to calibrate the instrument on air AND a LIFEH figure lower than 40% indicates that the % cell has failed. LIFEL and LIFEH readings can be obtained by referring to section 10.2.1

Note that LIFEL and LIFEH will only show correct values if the instrument has been calibrated during its use.

There are many reasons for cell failure whether premature or not so the LIFE values may not always show a true value as to how long the cell may be used..

Replacing the ppm cell:

Use the same procedure as in 16.1 or 16.2 above depending on the housing.

Replacing the % cell:

Remove the chassis from the instrument.

Pull out the customer terminal strips from their receptacles. Disconnect tubing and the power socket. Unscrew the four screws holding the rear panel to the chassis.

Unscrew the four front panel screws holding the front panel to the chassis.

Carefully withdraw the chassis from its housing .

Locate the % measuring cell towards the rear of the chassis as shown in the picture:



Disconnect the cell from its mounting and tube connection and reconnect the new cell bending the connecting pipes to suit.

Note: Ensure all replacement cells are exchanged like for like part numbers, otherwise it may be impossible to recalibrate the instrument and make sure that the following section is completed.

Note: Following a cell change it is recommended that the instrument be allowed to warm up, and the sample lines purged before a calibration is performed.

If you are in any doubt as to how to proceed, please contact Systech / Illinois for information.

16.4 Resetting the Calibration Range and Life Counter

After replacing a cell, the instrument must be calibrated to re-establish the calibration values (Span1 & Span2), which in turn will re-set the life values back to approximately 100%.

The instrument will only tolerate a certain level of adjustment during calibration.

Under normal circumstances the signal from the old cell would have reduced slowly and the relevant SPAN value would have increased during any calibration procedures, which in turn would have reduced the life value. On replacement of the cell, the strong signal from the cell will be re-established and on the first calibration attempt the value displayed could be very high and adjustment of it to the certified gas value could be rejected with "Cant" message. This is normally displayed when the value is outside 20% adjustment allowed, this however can be circumvented by making small adjustments until the required value is achieved.

Care must be taken that the high value indicated is not due to any leaks in the pipework or the fact that not enough time has been allowed for the certified gas bottle pressure regulator to purge out. It can take several minutes or even hours to sweep all of the air out of the pressure regulator and sample lines connected to a cylinder of a few ppm oxygen.

If after replacement of the cell the displayed reading is a lot lower than the certificated gas bottle connected to the analyser. This could be due to the relevant SPAN value having been reduced due to a miss-calibration before the cell was replaced.

The typical SPAN 1 & SPAN 2 values are listed below.

Cell Part #	Description	Typical Span1 value	Typical Span2 value
900 059	H2 Single RACE™ cell	1.060	0.300
900 057	H2 Trace Cell	1.060	N/A
900 047	% Cell	N/A	0.350
900 021	Trace Cell	0.246	N/A
900 055	Single RACE™ Cell	0.246	0.300
900 168	% Dual RACE™ Cell	N/A	0.300

17.0 SPARE PARTS

Part #	Description
400 006	Pcb front panel (quote serial number)
900 183	Pcb CPU (quote serial number)
900 081	Bypass flowmeter, Brass (910, 930)
900 115	Bypass flowmeter, St Steel (910, 930)
900 205	Sample flowmeter, stainless steel (910, 930)
900 206	Sample flowmeter, stainless steel (910, 930)
101 385	Bypass flowmeter, Brass (920)
900 118	Bypass flowmeter, stainless steel (920)
101 386	Bypass flowmeter, Brass (920)
900 207	Bypass flowmeter, stainless steel (920)
100 574	1/8" bulkhead (stainless steel)
100 575	1/8" bulkhead (brass)
100 549	Control valve (stainless steel)
100 715	Control valve (brass)
101 061	Pressure regulator (stainless steel)
100 499	Pressure regulator (brass)
900 116	Internal pump
900 180	Connector Transition 900MK3 0-10V

Important Note

The serial number of the instrument for which the spare parts are required must be quoted on all orders.

Measuring Cells

ELECTROCHEMICAL CELL WARRANTY (CURRENT INSTRUMENTS)				
Part No	Used In	Application	Description	Warranty Code
900 021	EC900	Trace Cell	Assy Cell Trace 900	A
900 028	EC900	Ultra Low Trace	Assy Cell Trace Ultra Low 900	A
900 032	EC900	Ultra Low Trace O2 in H2	Assy Cell Trace O2/H2 Ultra Low	A
900 047	EC900	Percent	Assy Cell % 900	C
900 055	EC900	Race™	Assy Cell Race	D
900 057	EC900	Trace O2 in H2	Assy Cell Trace O2 In H2	A
900 059	EC900	Race™ O2 in H2	Assy Cell Race O2 In H2 900	D
900 168	EC900	Percent Cell for use in Dual Race™ St. Steel tubes	Assy Cell O2% Stainless Steel (Race).	B

Important Note

The serial number of the instrument for which the spare parts are required must be quoted on all orders.

18.0 SERIAL NUMBER SUFFIX DETAILS

Systech Illinois have a process of continual development of their analyzers. Over the years there have been a number of changes in the basic instrument that have resulted in the suffix of the instrument being changed. These are as follows:

Suffix	Change Details	Change Date
A	RS485 Hardware fitted.	19/10/1999
B	5 segment display / switch PCB fitted.	28/11/2002
C	New Plastic front panel & CPU update.	01/11/2007
D	Dual race cell	
E	New PCB - MK 3 (900 172) (USB).	28/07/2010
F	New PCB - MK 3 (900 183) (USB)	25/05/2011
G	New PCB MK 4 -(900 218) - All 910's ENCO No. 1402 (EMC)	19/03/2015

REMOVE ALL BURRS AND SHARP EDGES

A3 ORIGINAL SIZE
DO NOT SCALE

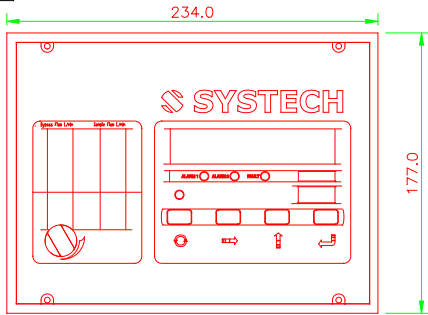

THIRD ANGLE PROJECTION

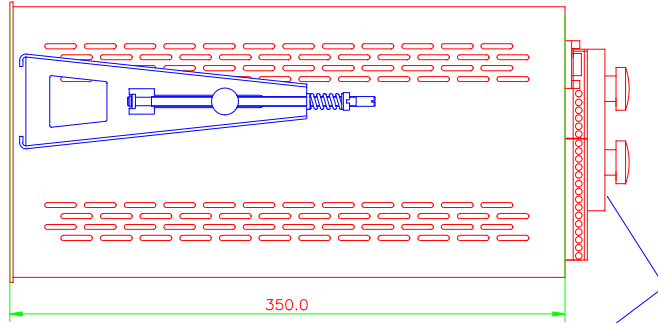

ALLOW AT LEAST 100mm CLEARANCE BEHIND THE INSTRUMENT FOR CONNECTIONS

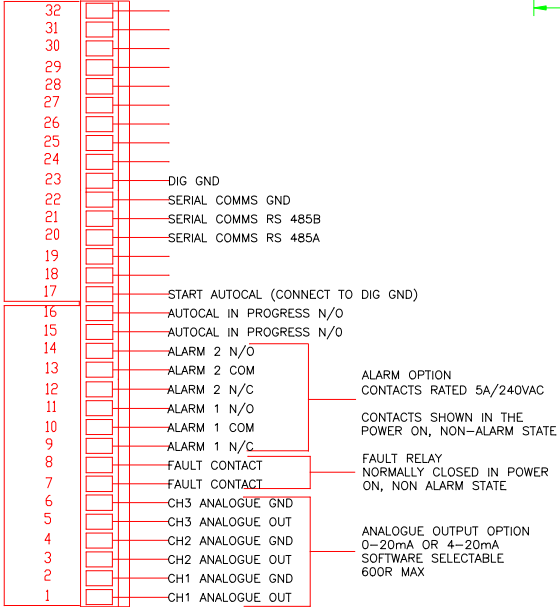
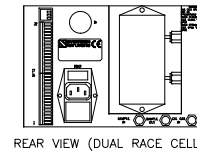
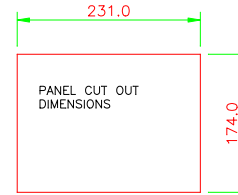
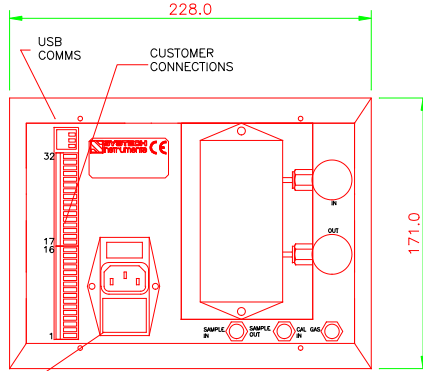

REAR VIEW (SINGLE RACE CELL)
WARNING POWER CONNECTION BLOCK 90-260 VAC

ISSUE	DESCRIPTION	APPD	DATE
B	ADDED INFORMATION RE DUAL RACE CELL	P.B.	09/14
A	NEW ISSUE	PB	07/10

THIS DRAWING IS CONFIDENTIAL AND MAY NOT BE COPIED OR DISCLOSED TO A THIRD PARTY WITHOUT PRIOR CONSENT IN WRITING FROM:
SYSTECH INSTRUMENTS LTD
17 Thame Park Business Centre
Wenman Road, Thame, Oxon, UK
OX9 3XA

MATERIAL	SCALE 1:1 UNLESS STATED	DRAWN BC
FINISH	TOLERANCES UNLESS STATED X ± 0.5mm XX ± 0.3mm XXX ± 0.1mm ANG ± 0° 15'	DATE 07/10
TITLE DIMENSIONS AND CONNECTIONS EC91X ANALYSERS		CHECKED BC
		APPROVED PB
		DRAWING NUMBER 900 176
		SHEET 1 OF 1

