

CONTROLLED ATMOSPHERE IR BELT FURNACE

NEW Model LA-306 Operation & Theory

**Infrared Furnace Setup, Operation,
Theory and Troubleshooting Guide**
3rd Edition

*Stephen L. Barber
James M. Clark*



Covers 2014 – 2017 LCI LA-306 Models
Includes supplement for LCI refurbished RTC LA-306 models

This manual contains operating instructions, theory and information regarding features and options which may or may not be included in your furnace system.

Controlled Atmosphere IR Belt Furnace

Model: LA-306 (2014-2017)

Operation & Theory

Third Edition

Part No. 676-170306-01 CD

Part No. 676-170306-02 Perfect bound

Part No. 676-170306-03 Casewrap Hardcover

By: Stephen L. Barber, James M. Clark

Photography by: Chris Roode

Published by:

Lochaber Cornwall, Inc., 675 North Eckhoff Street, Ste D, Orange, California 92868 USA

714.935.0302

www.LCIfurnaces.com

service@furnacepros.com

Copyright ©2017 by Lochaber Cornwall, Inc., Orange, California, USA. All rights reserved.

ISBN: 978-1-304-36724-2

ID: 14066613

Manufactured in the United States of America.

Limit of Liability/Disclaimer of Warranty. The information in this document is subject to change without notice. The statements, configurations, technical data and recommendations in this document are believed to be accurate and reliable, but are presented without express or implied warranty. The publisher and author make no representation or warranties with respect to the accuracy or completeness of the contents of this work and specifically disclaim all warranties including without limitation warranties of fitness for a particular purpose. No warranty may be created or extended by sales or promotional materials. The advice and strategies contained herein may not be suitable for every situation. If professional assistance is required, the services of a competent professional should be sought. Neither the publisher nor the author shall be liable for damages arising therefrom. Warranties for FurnacePros or Lochaber Cornwall, Inc. products and services shall be limited to those are set forth in the express warranty statements accompanying such products and services. Nothing herein should be construed as constituting an additional warranty. THERE ARE NO OTHER WARRANTIES, EXPRESS, STATUTORY OR IMPLIED, INCLUDING THOSE OF MERCHANTABILITY AND OF FITNESS FOR PARTICULAR PURPOSE, NOR ANY AFFIRMATION OF FACT NOR REPRESENTATION WHICH EXTENDS BEYOND THE DESCRIPTION OF THE FACE HEREOF.

Users must take full responsibility for their application of any products, recommendations, processes or procedures mentioned in this document. Lochaber Cornwall shall not be liable for technical or editorial errors or omissions contained herein. The information in this document is proprietary to Lochaber Cornwall, Inc.

No part of this publication may be reproduced or transmitted in any form or by any means, electronic or mechanical without express written permission from the publisher.

For information on parts, service and aftermarket products and reconditioned furnaces and to obtain technical support please contact FurnacePros Aftermarket Services at +1.714.935.0302.

Trademarks. LCI, LCI Furnaces, Lochaber Cornwall logo and shield and FurnacePros logo are trademarks or registered trademarks of Lochaber Cornwall, Inc. All other trademarks are the property of their respective owners.

Library of Congress Cataloging-in-Publication Data.

Controlled Atmosphere Belt Furnace, Operation & Theory, LA-306 Models / Stephen L. Barber, James M. Clark

ISBN 978-1-304-36724-2 (paper)

1. Infrared Furnace 2. IR Furnace Operation 3. IR Furnace Setup 4. Process Engineering
5. Thermal Processing Theory 6. LA-306 I. Title.

Price US \$160.00

INTRODUCTION

This manual covers the LCI LA-306, high quality controlled atmosphere infrared belt furnace designed for industrial production and laboratory continuous infrared thermal processing. This edition is for models manufactured in 2014 and later, controlled with a programmable logic controller (PLC) and the closed-loop belt speed control introduced in 2013.

Achieving high performance and high yields is attainable with careful adjustment of the sophisticated digital temperature controllers and exceptional process gas system provided on the LA-306. Infrared furnaces are highly responsive to critical temperature settings. With lamps as the primary heat source, the equipment is literally heating with light. The unique gas management system provides an extremely even distribution and well-regulated flow of gas throughout the process chambers. While the furnace is very easy to use, understanding how to control both the heat and gas flow is essential to achieve exceptional performance of the furnace. When the interaction of the control elements is well managed, the tool can achieve its potential. For many, our furnaces become regarded more than just an effective tool; they are viewed as a fine instrument that can produce results over a variety of thermal processing conditions.

WHAT IS IN THIS MANUAL

This manual explains furnace equipment installation and setup, operation and troubleshooting of LA-306 PLC controlled furnaces manufactured by LCI. Some equipment described in this manual is optional or may not apply to your model as configured. The manual also covers aspects of infrared processing theory and techniques to assist you in achieving highly repeatable and reliable thermal processes.

Study this manual carefully. Experience has shown that operators who thoughtfully master the contents of this manual can become expert in understanding the process system capabilities of our infrared furnaces. In doing so, many are able to push the initial process performance envelope and thus achieve higher degrees in both process reliability and throughput than previously anticipated.

Note that throughout this Owner's Manual the equipment is generally referred to as a furnace. A dryer is a furnace with only the top lamp elements installed or operated.

FORMATTING CONVENTIONS

This manual uses the following formatting conventions.



DANGER: This signifies a potential threat to human safety.

Warning: This signifies a potential threat to equipment damage or product loss.

Note: This signifies an important fact that could affect process control.

Examples are shown in italic text.

Bold text words or phrases embedded in this document, are terms with definitions in the glossary.

Bold Underlined text is used for pop-up windows, button descriptions & selector button/box choices.

Cross-references to "Section Titles" are bound with quotes.

(Optional) accessories will be shown in parenthesis with a checkbox. If supplied, please check the box as appropriate.

ABOUT LCI

LCI Furnaces specializes in the manufacture and sales of near infrared (0.5-5.5 μm) wavelength continuous belt dryers, ovens and furnaces worldwide. We provide the highest quality controlled atmosphere infrared thermal processing equipment, parts and service available anywhere.

We endeavor to improve our equipment design and performance. To this end, LCI encourages users to suggest ideas for improving designs and service. Additionally, we will discuss, in confidence, new thermal processing requirements, however difficult or routine they may be. If needed, LCI can design new equipment and features to meet the special and challenging needs our partners require.

Should you have a furnace operating question, contact LCI Furnaces or FurnacePros Technical Support.

WHERE TO GET HELP

Corporate Offices & Factory

Address: 675 N Eckhoff St, Ste D
Orange, California 92868 USA
e-mail: admin@lochabercornwall.com
Phone: +1 (714) 935-9781

Technical Support & Service

Department: Aftermarket
e-mail: service@furnacepros.com
Phone: +1 (714) 935-0302 x230

Aftermarket Parts Ordering

Department: Aftermarket
e-mail: parts@furnacepros.com
Phone: +1 (714) 935-0302 x230

Equipment Sales, Upgrades & Factory Reconditioning

Department: Sales & Marketing
e-mail: info@lCIFurnaces.com
Phone: +1 (714) 935-0302 x250

Websites

New Furnaces: www.LCIFurnaces.com
Aftermarket Parts: www.FurnacePros.com

GENERAL SAFETY GUIDELINES

The following set of guidelines is intended to create awareness of potential health and safety hazards.

Normal Good Laboratory Practice

Normal good laboratory practices apply to the operation of IR furnaces. Do not use the space above the furnace as storage. Do not block the cabinet doors preventing the cooling of the electronic equipment inside. Do not operate with side covers off as this will prevent normal cooling of the electronic equipment thus voiding the warranty. Tuck electrical cords out of the way. Do not store flammables in the vicinity of the furnace and especially while operating the furnace with an oxygen atmosphere.

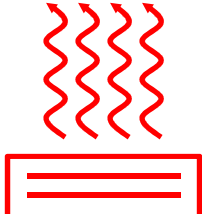

HIGH TEMPERATURES. In general, the operation of any furnace may expose operators or maintenance technicians to the risk of burns. After being processed in an infrared furnace, customer product may still be dangerous to handle. Each owner is responsible for providing a safe work environment and proper training in the handling of material being processed in a furnace.

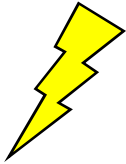

ELECTRICAL SHOCK HAZARD. IR furnaces operate at high voltages. Operation with side covers off constitutes a safety hazard. Ensure that main power is off while side covers are removed.

Electrical shock hazards exist for those technicians who service the furnace. High voltages are required to operate the furnace and precautions must be taken to reduce the exposure to these elements. Again, it is the responsibility of the furnace owner to assure that only properly trained service technicians, familiar with high voltage operations be allowed to service the equipment



EXPLOSION Explosive dangers may exist in the high temperature process environment of the furnace. If the furnace operates with process gas containing hydrogen, the hydrogen content must be below 4.5% to assure the avoid the dangers of explosion. Furthermore, improper gas flow balance may draw oxygen rich air into the furnace, mixing with effluent gases and material from products, also creating a hazardous environment.



HAZARDOUS MATERIALS. Persons performing maintenance tasks such as replacement of lamps may become exposed to silica fiber compounds and/or toxic process residue. Such tasks should be performed by qualified persons wearing gloves, eye protection and a facemask to prevent inhalation of particulates or contact with toxic materials.

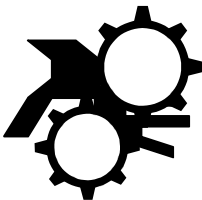

ROTATING EQUIPMENT. Roller dangers exist when working around the conveyor belt of the furnace. Care should be taken not to place hands or garments on or near the belt drive mechanisms when the conveyor system is operating as roller crush may occur. Operators should avoid walking near the open ends of the conveyor belt. Those who must be near the moving parts should wear close fitting clothing.

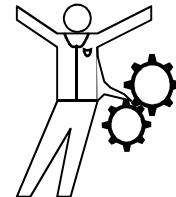

SAFETY EQUIPMENT

EMO Buttons



Each LA-306 infrared furnace is fitted with at least two SEMI S2 compliant Emergency Machine Off buttons (EMO's), one located at each end of the furnace. Each Emergency Machine Off button (EMO) is attached directly to a switch that automatically shuts down all furnace electrical systems. In many cases, process gas flow will remain on after power is shut off.

Locate the EMO buttons and insure their proper function prior to regular furnace operation.

Panel Interlock Switches

The LA-306 has (3) interlock switches positioned to prevent operation of the furnace with high voltage panel access covers out of place. One is located on the control enclosure hinged back access door, and one on each of the lower side panels closest to the furnace entrance safeguarding access to the high voltage at the chamber lamps. The control enclosure top access plate is not interlocked.

Bypass this switch to allow furnace operation with the panels removed. Grasp the protruding switch and pull it out to override the switch (see Figures). Setting the panel switches in bypass mode is useful during SCR calibration and other troubleshooting.

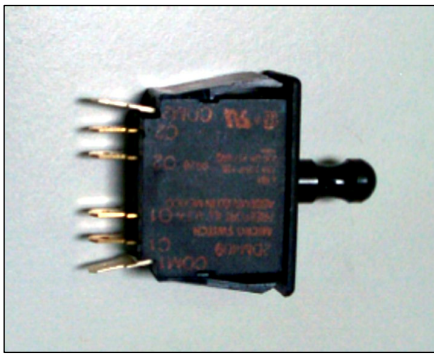

Panel Switch in Normal Operation Position (in)



Panel Switch Installed - Bypass (out) Position



DANGER: Bypassing the panel interlock switches increases maintenance personnel exposure to electrical hazards. The user must ensure that any interlock switches placed in override mode are returned to normal operation following any inspection or adjustment.

CDA Mixing

CDA Mixing options allows for introduction as GAS2, clean dry compressed air (CDA), nitrogen, forming gas or a specialty gas into specific furnace zones. When enabled, GAS2 can be added to the GAS1 flow introduced through the GAS FLOW CONTROL flowmeters (See Operation with FG below if operation with forming gas is contemplated.)

Operation with FG (Forming Gas): Nitrogen/Hydrogen Premix

The CDA Mixing and Dual Gas options each provide for use of forming gas (FG) as a process gas. Use of FG is generally safe provided the concentration of hydrogen in the mixture is lower than the lower flammable limit of hydrogen. Hydrogen is flammable in concentrations of 4.5%-74% in air; explosive range is 18-59% in air. Dual gas furnaces are equipped with an audible alarm to indicate low nitrogen and forming gas supply pressure. CDA mixing furnaces are equipped with an audible alarm to indicate low nitrogen supply pressure only.



DANGER: Except for furnaces specifically equipped with the hydrogen option, combustible gas should NOT be connected to the furnace. Forming gas or other gas mixtures which have a combustible gas component can be safely introduced into furnace provided the delivered concentration is below its lower flammable limit (LFL) in air.

INTRODUCTION	iii	Chapter 4	4-1
WHAT IS IN THIS MANUAL	iii	OPERATION	4-1
ABOUT LCI	iv	4.1 Furnace Operation.....	4-1
GENERAL SAFETY GUIDELINES	v	4.2 Furnace Alerts & Alarms.....	4-5
CONTENTS	vii	4.3 Energizing Lamps.....	4-8
Chapter 1	1-1	4.4 Belt Speed Considerations.....	4-8
FURNACE EQUIPMENT	1-1	4.5 Testing Lamps.....	4-9
1.1 Furnace Description.....	1-1	4.6 Gas Flow Control.....	4-10
1.2 Furnace Views.....	1-2	Chapter 5	5-1
1.3 Thermal Process Elements.....	1-4	MODIFYING CONTROL STRATEGIES	5-1
1.4 Heat Transfer Methods.....	1-4	5.1 Modifying Zone Controllers.....	5-1
1.5 Controlled Atmosphere.....	1-5	5.2 Controller PID Tuning.....	5-4
1.6 Hermetically Sealed Systems.....	1-5	5.3 Automatic PID Group Selection.....	5-8
1.7 Furnace Process Equipment.....	1-5	5.4 Manual PID Group Selection.....	5-8
1.8 Load Station (LOAD).....	1-5	5.5 Viewing Controller Output Level.....	5-8
1.9 Entrance Baffle & Exhaust Stack (BE).....	1-5	5.6 Restoring Factory Presets.....	5-9
1.10 Chamber.....	1-6	Chapter 6	6-1
1.11 Transition Tunnel (TT).....	1-7	OPTIONAL EQUIPMENT	6-1
1.12 Cooling Tunnel (CACT).....	1-7	6.1 Options Summary.....	6-1
1.13 Unload Station (UNLOAD).....	1-7	6.1 Air Filter Regulator (AFR option <input type="checkbox"/>).....	6-1
1.14 Console Controls & Indicators.....	1-8	6.2 Gas Reservoir (AR10 option <input type="checkbox"/>).....	6-1
1.15 Programmable Logic Controller (PLC).....	1-15	6.3 Alternate Belt Speed (option <input type="checkbox"/>).....	6-1
1.16 Furnace Auxiliary Equipment.....	1-16	6.4 Circuit Breaker (CB-3 option <input type="checkbox"/>).....	6-2
Chapter 2	2-1	6.5 3-Phase Electrical (ELECT-3PH option <input type="checkbox"/>).....	6-2
INSTALLATION	2-1	6.6 European Certification (CE option <input type="checkbox"/>).....	6-3
2.1 Unpacking the Equipment.....	2-1	6.7 Load Extension (CXE15 option <input type="checkbox"/>).....	6-3
2.2 Location & Initial Installation Work.....	2-1	6.8 Unload Extension (CXX15 option <input type="checkbox"/>).....	6-3
2.3 Providing Power.....	2-6	6.9 Dual Gas (DGO option <input type="checkbox"/>).....	6-4
2.4 Providing Process Gas.....	2-8	6.10 H2/N2 Mixing (HO/NHM option <input type="checkbox"/>).....	6-4
2.5 Analyzers and Sampling.....	2-10	6.11 Intermediate Exhaust (IE option <input type="checkbox"/>).....	6-5
2.6 Product Alert Sensors.....	2-11	6.12 Supply Gas Mixing (GSM option <input type="checkbox"/>).....	6-6
2.7 Exhaust Requirements.....	2-12	6.13 Line Filter (LFI option <input type="checkbox"/>).....	6-7
2.8 Water and Drain Connections.....	2-14	6.14 Moisture Analyzer (MA option <input type="checkbox"/>).....	6-7
Chapter 3	3-1	6.15 Oxygen Analyzer (OA option <input type="checkbox"/>).....	6-8
INITIAL SETUP	3-1	6.16 Sample System (OSS option <input type="checkbox"/>).....	6-10
3.1 Emergency Machine Off Switch (EMO).....	3-1	6.17 Chamber Height, 1-in (PH1 option <input type="checkbox"/>).....	6-11
3.2 Interlocks.....	3-1	6.18 Chamber Height, 4-in (PH4 option <input type="checkbox"/>).....	6-11
3.3 Control Console.....	3-1	6.19 Belt Travel, Right to Left (RTL option <input type="checkbox"/>).....	6-11
3.4 Functional Checkout.....	3-2	6.20 Product Alert (SENSLAS option <input type="checkbox"/>).....	6-12
		6.21 Sample Ports (SSP option <input type="checkbox"/>).....	6-13
		6.22 Ultrasonic Cleaner (UCD option <input type="checkbox"/>).....	6-14

Contents

6.23 Uninterruptable Power Supply (UPS option□).....	6-14
--	------

Chapter 7 **7-1**

SERVICE & MAINTENANCE 7-1

7.1 Service and Maintenance Access	7-1
7.2 Routine Maintenance	7-7
7.3 Daily Maintenance	7-7
7.4 Monthly Maintenance	7-7
7.5 Other Recommended Maintenance	7-7
7.6 Troubleshooting	7-11
7.7 Troubleshooting Process Problems	7-16
7.8 Service	7-18
7.9 Calibration.....	7-28

Chapter 8 **8-1**

PROCESS ENGINEERING 8-1

8.1 IR Furnace Process	8-1
8.2 Furnace Construction	8-3
8.3 Heating Chamber Design	8-4
8.4 PID Tuning Concepts	8-6
8.5 Gas Flow.....	8-8

Chapter 9 **9-1**

THERMAL PROCESSING THEORY 9-1

9.1 Infrared Waves	9-1
9.2 Infrared Heating	9-2
9.3 Thermal Process	9-3
9.4 Temperature Profiling	9-3

Chapter 10 **10-1**

DRAWINGS & SCHEMATICS 10-1

10.1 Furnace Arrangement LA-306	10-2
10.2 Furnace Arrangement LA-306 Extended.	10-3
10.3 Furnace Chamber.....	10-4
10.4 Furnace Chamber, Intermediate Exhaust	10-5
10.5 Process Gas Plumbing, Single Gas	10-6
10.6 Process Gas Plumbing, Dual Gas	10-7
10.7 Supply Gas Mixing.....	10-8
10.8 Analyzer Gas Sample System.....	10-9
10.9 Safety Panel (208-240 Vac)	10-10
10.10 Safety Panel (380-415 Vac).....	10-11
10.11 Power Control, PLC LA-306.....	10-12
10.12 Frame Wiring.....	10-13
10.13 Control Console.....	10-14
10.1 Zone Control (After 2015).....	10-15
10.1 Element Wiring	10-16

10.1 Element Wiring – Hi Power.....	10-17
10.2 Analyzer & OSS Control	10-18
10.1 Product Alert with PLC.....	10-19

Chapter 11 **11-1**

SPECIFICATIONS 11-1

11.1 Furnace Specifications	11-2
11.2 Fuse List	11-3
11.3 Average 3-ph Current at Temperature	11-4
11.4 Average 1-ph Current at Temperature	11-5

Chapter 12 **12-1**

APPENDIX - MSDS 12-1

12.1 MSDS M0090 Fiberfrax® QF Cements..	12-2
12.2 MSDS M0042 Fiberfrax® Duraboard®...	12-8
12.3 Fiberfrax® Refractory Ceramic Fiber MSDS 0001	12-14
12.4 MSDS M0055 Fiberfrax® High Purity Papers	12-20
12.5 Kaowool® Insulation MSDS 203	12-26
12.6 MSDS 0732 RTV Silicone 732	12-31
12.7 MSDS MagnaForm Boards	12-32

Chapter 13 **13-1**

GLOSSARY 13-1

Chapter 14 **14-1**

RTC LA-306 SUPPLEMENT 14-1

14.1 The Rebuilt RTC LA-306	14-1
14.2 Console Controls & Indicators	14-2
14.3 Installation.....	14-5
14.4 Initial Setup	14-5
14.5 Operation	14-5
14.6 Modifying Control Strategies	14-5
14.7 Service & Maintenance.....	14-5
14.8 MSDS	14-5
14.9 Specifications.....	14-6
14.10 Average Current vs. Temperature.....	14-7
14.11 RTC LA-306 DRAWINGS.....	14-8
14.12 Furnace Arrangement, RTC LA-306	14-9
14.13 Furnace Chamber, RTC LA-306	14-10
14.14 Frame Wiring – Refurb RTC LA-306 ..	14-11

Chapter 15 **15-1**

Furnace Configuration 15-1

FIGURES

Figure 1-1 Furnace Front Elevation	1-1	Figure 2-7 Belt Orientation	2-4
Figure 1-2 Furnace Front Elevation	1-2	Figure 2-8 Belt Splice	2-4
Figure 1-3 Entrance Elevation.....	1-2	Figure 2-9 Lower Access Panel	2-5
Figure 1-4 Exit Elevation	1-2	Figure 2-10 Belt Weight with packing.....	2-5
Figure 1-5 Exit Elevation	1-2	Figure 2-11 Belt Weight in Place.....	2-5
Figure 1-6 Rear Elevation	1-3	Figure 2-12 Proper Alignment of Belt Weight.....	2-5
Figure 1-7 Top Front View	1-3	Figure 2-13 Standard Back Entry Power Port.....	2-6
Figure 1-8 Process Sections	1-4	Figure 2-14 1-PH.....	2-6
Figure 1-9 Furnace Internals.....	1-5	Figure 2-15 208-240Vac, 3-PH, 4 wire.....	2-6
Figure 1-10 LA-306 Control Console	1-8	Figure 2-16 380-415Vac, 3PH 4-wire.....	2-6
Figure 1-11 Power control panel.....	1-8	Figure 2-17 Single Phase Circuit Breaker.....	2-7
Figure 1-12 Energize Lamps control panel.....	1-9	Figure 2-18 3-Phase Circuit Breaker (Option)....	2-7
Figure 1-13 Zone Temperature Controllers	1-10	Figure 2-19 Process Gas Connections – Single Gas.....	2-8
Figure 1-14 Temperature Controller Indicators and Control Buttons	1-10	Figure 2-20 Process Gas Connections - Dual Gas.....	2-8
Figure 1-15 Transport Panel	1-11	Figure 2-21 Process Gas Connections with.....	2-9
Figure 1-16 Test Panel.....	1-12	Figure 2-22 Oxygen analyzer on furnace.....	2-10
Figure 1-17 Zone Lamp Strings–Standard.....	1-12	Figure 2-23 Analyzer power & sample line connection.....	2-10
Figure 1-18 Zone Lamp Strings–High Power....	1-12	Figure 2-24 Install SENSLAS bracket	2-11
Figure 1-19 Status Panel	1-13	Figure 2-25 Adjust SENSLAS bracket height....	2-11
Figure 1-20 Gas Flowmeters - Single Gas.....	1-14	Figure 2-26 Install SENSLAS sensor over center of product lane	2-11
Figure 1-21 Gas Flowmeters - Dual Gas	1-14	Figure 2-27 Connect SENSLAS cable	2-11
Figure 1-22 PLC and Power Supply.....	1-15	Figure 2-28 Exhaust Connection.....	2-12
Figure 1-23 PLC CPU	1-15	Figure 2-29 Exhaust Connection Detail	2-12
Figure 1-24 Pressure Switch.....	1-16	Figure 2-30 Typical Hydrogen Furnace Process Gas Exhaust Connection	2-13
Figure 1-25 Motor Controller	1-17	Figure 2-31 UCD Water Connections	2-14
Figure 1-26 PCM21010A Motor Controller	1-17	Figure 3-1 EMO Switch	3-1
Figure 1-27 Drive Motor	1-18	Figure 3-2 Lower Panel Interlock	3-1
Figure 1-28 Transport Drive DC Motor.....	1-18	Figure 3-3 LA-306 Control Console ON.....	3-1
Figure 1-29 Encoder	1-18	Figure 4-1 Process Gas Control Flowmeters....	4-10
Figure 1-30 Encoder Connections	1-18	Figure 6-1 3-Phase Circuit Breaker (Option).....	6-2
Figure 2-1 Name Plate	2-1	Figure 6-2 3-Phase Electrical (Option).....	6-2
Figure 2-2 Shipping Brackets.....	2-2	Figure 6-3 CE Mark.....	6-3
Figure 2-3 Leveling Feet	2-3	Figure 6-4 Unload station with CXX15.....	6-3
Figure 2-4 Chamber Support Bracket	2-3	Figure 6-5 Control Enclosure showing 3 options:	6-4
Figure 2-5 Location of Support Brackets	2-3	Figure 6-6 LA-306 with Intermediate Exhaust....	6-5
Figure 2-6 Belt Path	2-4		

Contents

Figure 6-7 Supply Gas Mixing System Control Panel	6-6	Figure 7-19 PCL CPU ERR Indicator	7-16
Figure 6-8 MM510 Moisture Analyzer	6-7	Figure 7-20 Cut Wire at Ball Joint	7-18
Figure 6-9 EC913 Oxygen Analyzer	6-8	Figure 7-21 Second Cut at Opposite Side	7-18
Figure 6-10 Oxygen Analyzer with OSS	6-8	Figure 7-22 Remove belt wire	7-18
Figure 6-11 Oxygen Analyzer next to Control Console	6-8	Figure 7-23 Belt Splice	7-19
Figure 6-12 EC913 Oxygen Analyzer Rear View	6-9	Figure 7-24 Belt Orientation	7-19
Figure 6-13 EC913 Oxygen Analyzer Rear View	6-9	Figure 7-25 Belt Path	7-19
Figure 6-14 Sample System control panel	6-10	Figure 7-26 Insert Splice Wire	7-20
Figure 6-15 EC913 Oxygen Analyzer Rear Controls	6-10	Figure 7-27 Belt Splice	7-20
Figure 6-16 LTR and RTL Furnaces	6-11	Figure 7-28 Belt Weight in Place	7-20
Figure 6-17 SENSLAS System	6-12	Figure 7-29 Proper Alignment of Belt Weight....	7-20
Figure 6-18 SENSLAS Control Panel	6-12	Figure 7-30 Sprocket Alignment.....	7-21
Figure 6-19 Calibrate Sensor	6-12	Figure 7-31 Belt Tracking Adjustment Diagram	7-22
Figure 6-20 Sample Port Chamber Penetration	6-13	Figure 7-32 Drip Tray Cleaning Diagram	7-23
Figure 6-21 Zone Port Locations.....	6-13	Figure 7-33 Air Rake Alignment Ring.....	7-23
Figure 6-22 Ultrasonic Cleaner installation	6-14	Figure 7-34 Replacing the PLC Battery.....	7-24
Figure 7-1 Front Access Panels	7-1	Figure 7-35 Lamp Indicator Installation	7-26
Figure 7-2 Front Access Panels	7-2	Figure 7-36 Lamp in Panel	7-26
Figure 7-3 Rear Access Panels.....	7-2	Figure 7-37 Lamp Replacement.....	7-27
Figure 7-4 Control Enclosure Access Door Closed	7-3	Figure 7-38 Belt Speed Calibration Diagram ...	7-30
Figure 7-5 Access Door Open.....	7-3	Figure 7-39 Speed Adjust Tips	7-30
Figure 7-6 Lower Access Panel Removal	7-3	Figure 7-40 Belt Speed Display Meter	7-32
Figure 7-7 Lower Access Panel Installation	7-3	Figure 7-41 IPS Inlet Pressure Switch	7-34
Figure 7-8 Hanging Lower Access Panel.....	7-3	Figure 7-42 Air Pressure sensor	7-34
Figure 7-9 Hanging Lower Access Panel.....	7-3	Figure 8-1 IR Furnace Process Sections	8-1
Figure 7-10 Top Panel In Place.....	7-4	Figure 8-2 Heating Chamber Construction. End view	8-4
Figure 7-11 Entrance Panels.....	7-4	Figure 9-1 Dominant Wavelength Graph	9-1
Figure 7-12 Drive Enclosure Access Panels	7-4	Figure 9-2 Temperature Profile	9-3
Figure 7-13 Transport Drive (at Furnace Exit)	7-5	Figure 9-3 Equilibrium Profile	9-5
Figure 7-14 Typical Oxygen Analyzer furnace connections	7-5	Figure 9-4 Non-equilibrium profile	9-5
Figure 7-15 O ₂ Analyzer-front view	7-6	Figure 9-5 Temperature Profiling Apparatus.....	9-6
Figure 7-16 O ₂ Oxygen Analyzer rear view	7-6	Figure 9-6 Data Logger	9-6
Figure 7-17 Test Panel: Lamp String Failure Indicator	7-14	Figure 9-7 Brass Forging Sample	9-7
Figure 7-18 Tips on Adjusting Belt Speed.....	7-16	Figure 9-8 Metal Plate Sample.....	9-7
		Figure 9-9 Silicon Wafer Entering Furnace	9-7
		Figure 9-10 Recording Setpoints.....	9-7
		Figure 9-11 Brass forging sample exiting furnace.....	9-8

Figure 9-12 Sample plate exiting furnace	9-8	Figure 14-3 RTC LA-306 Control Console	14-2
Figure 9-13 880 °C Annealing profile	9-10	Figure 14-4 Minarik Motor Controller	14-3
Figure 9-14 880 °C Brass Forging profile	9-10	Figure 14-5 IronHorse Motor Controller	14-3
Figure 9-15 250 °C Curing Profile	9-11	Figure 14-6 PCM21010A Motor Controller.....	14-3
Figure 9-16 860 °C Thick Film profile	9-11	Figure 14-7 IronHorse GSD4-240-1C Motor Controller	14-3
Figure 9-17 860 °C Spike profile	9-12	Figure 14-8 Drive Motor	14-4
Figure 9-18 652 °C 1205 Brazing profile.....	9-12	Figure 14-9 Transport Drive DC Motor.....	14-4
Figure 14-1 RTC LA-306 Furnace Front Elevation	14-1	Figure 14-10 Encoder.....	14-4
Figure 14-2 Entrance	14-1	Figure 14-11 Encoder Connections	14-4

TABLES

Table 1-1 Furnace Arrangement.....	1-6
Table 1-2 Furnace Lamps Wiring Configuration	1-6
Table 1-3 Initial Pressure Alarm Settings	1-16
Table 1-4 Transport Drive Components	1-17
Table 3-1 Functional Checkout.....	3-2
Table 4-1 Cold Start Up	4-1
Table 4-2 Changing the Profile	4-2
Table 4-3 Standby.....	4-3
Table 4-4 Resume Operation from Standby	4-3
Table 4-5 Shut Down	4-4
Table 4-6 Alerts & Alarms – Controls ON	4-5
Table 4-7 Alerts & Alarms – Lamps ON.....	4-6
Table 4-8 Over Temperature Alarm.....	4-7
Table 4-9 Lamp String Test	4-9
Table 5-1 Unlock/Lock Temperature Controller Keys.....	5-1
Table 5-2 Changing Temperature Deviation Alert Limits.....	5-2
Table 5-3 Changing Over temperature Alarm Limit.....	5-2
Table 5-4 Changing READY Light Limits.....	5-3
Table 5-5 Factory Default Zone Controller PID Parameters.....	5-4
Table 5-6 View & Change PID Parameter Group.....	5-5
Table 5-7 Zone Auto Tuning	5-6

Contents

Table 5-8 Start/Stop Autotune Process	5-7
Table 5-9 View Temperature Controller Output Level	5-8
Table 5-10 Restore Temperature Controller Factory Settings.....	5-9
Table 5-11 Restore Temperature Controller Factory Operation Settings.....	5-10
Table 6-1 Summary of Advanced Features & Options	6-1
Table 7-1 Recommended Maintenance & Frequency	7-8
Table 7-2 Troubleshooting Power	7-12
Table 7-3 Temperature Control Troubleshooting.....	7-14
Table 7-4 Zones, Lamp Strings and Lamps.....	7-15
Table 7-6 Initial Alarm Settings	7-34
Table 9-1 Equilibrium Belt Speed Recommendations	9-9
Table 14-1 Transport Drive Components	14-2
Table 14-2 Applicable Drawings for LCI Rebuilt RTC LA-306.....	14-8

FURNACE EQUIPMENT

Description of the LA-306 IR furnace basic thermal process elements, standard hardware and their functions. Refer to Chapter 6 for optional equipment description and operation.

1.1 Furnace Description

The LA-306 is a 1000 °C compact, near-infrared, conveyor belt furnace for laboratory and general purpose thermal processing in a controlled atmosphere, free of outside contamination. Process gas may be CDA, N₂ or another inert gas. Dual gas furnaces may use Nitrogen and a reducing gas such as Forming Gas (pre-mixed N₂/H₂) or another type of process gas introduced into the heating chamber.

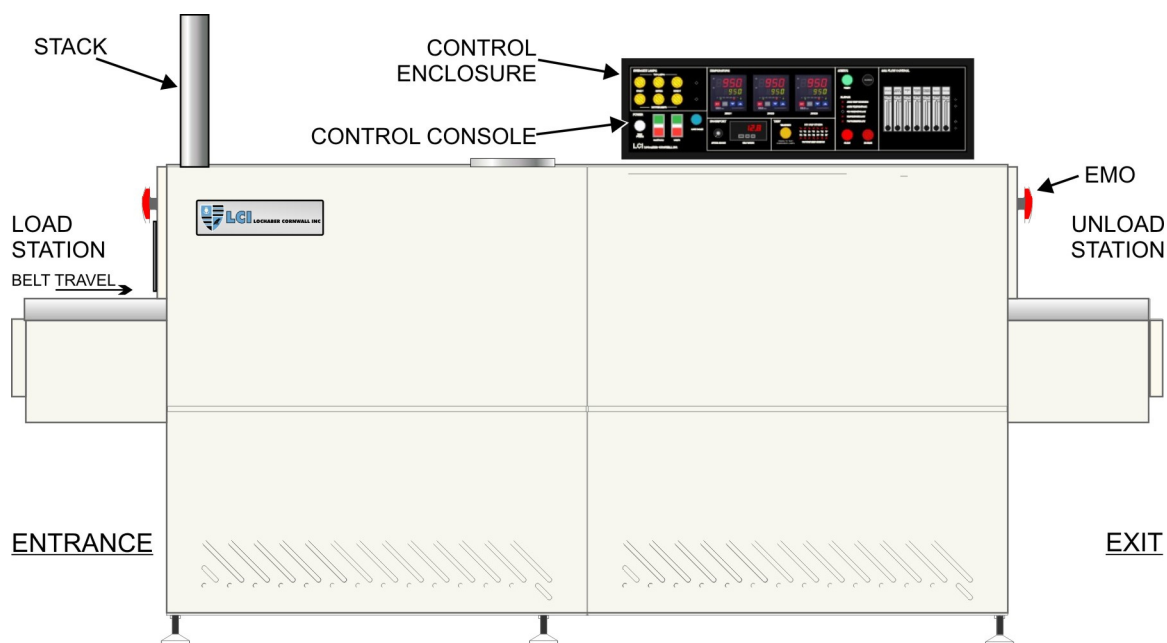
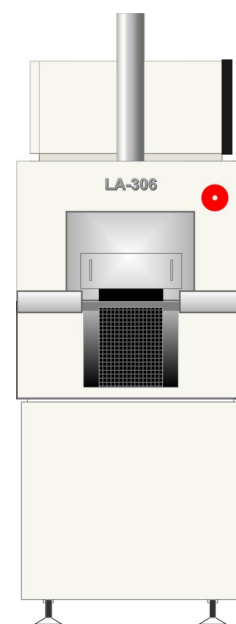

Figure 1-1 Furnace Front Elevation

The LA-306 furnace transports product on a moving 150 mm (6-inch) wide belt. In the standard design the chamber clearance above the belt is 50 mm (2 inches). Optionally the furnace can be ordered with 25 mm (1-inch) or 100 mm (4-inch) vertical clearance above belt. LA-306 furnaces feature a hermetically sealed heating chamber permitting atmospheric control of the furnace chamber process environment. Baffle sections before and after the heating section contain curtains that hang down to just above the belt to further isolate the furnace chamber from the room atmosphere and from the cooling section.

The LA-306 can process substrates, wafers, PCBs, metal, ceramic, glass or polycarbonate parts for electronic package sealing, thermo-setting polymer curing, reflow soldering, copper and hybrid/thick film firing, brazing, annealing, brazing, tempering and metal sintering applications, or almost any kind of general thermal processing requiring precision temperature control in a controlled atmosphere environment.

The LA-306 can also be used for precise curing of coatings on optical lenses, advanced thin film crystalline silicon, cadmium telluride (CdTe alloys) and certain copper indium diselenide (CIS-alloys) as well as many dental lab and production applications.



1.2 Furnace Views



Figure 1-2 Furnace Front Elevation

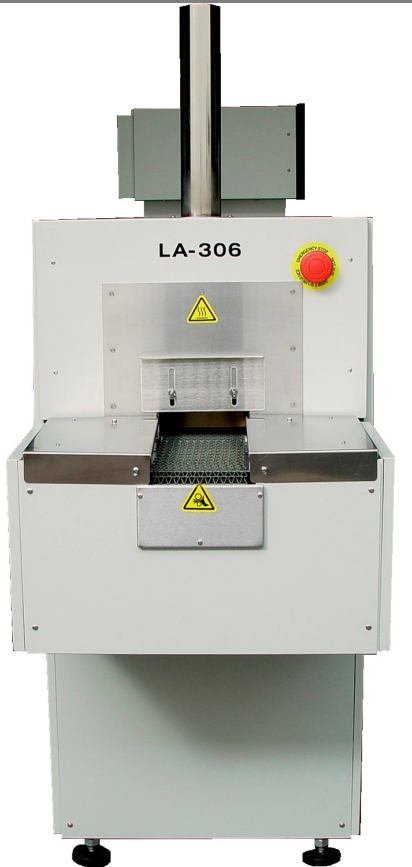

Figure 1-3 Entrance Elevation



Figure 1-4 Exit Elevation



Figure 1-5 Exit Elevation (with GSM Option)

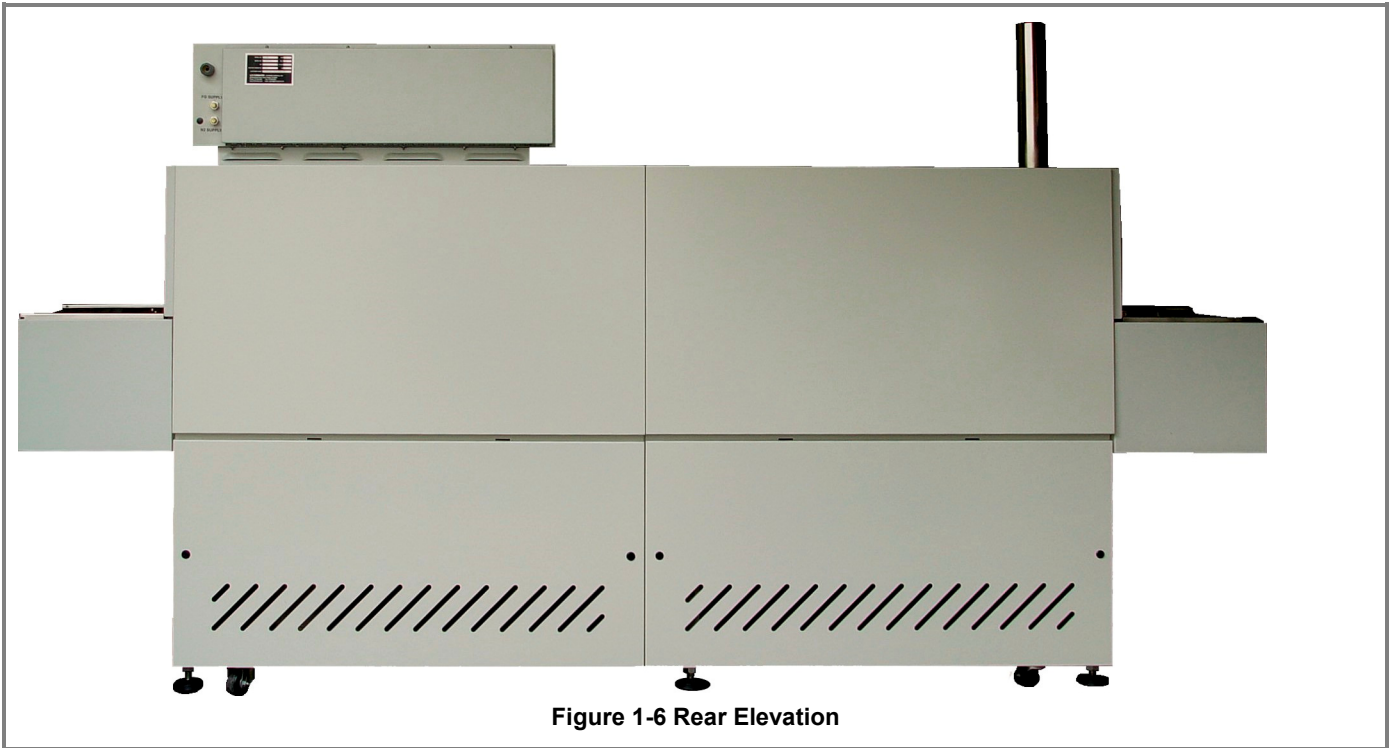

Figure 1-6 Rear Elevation

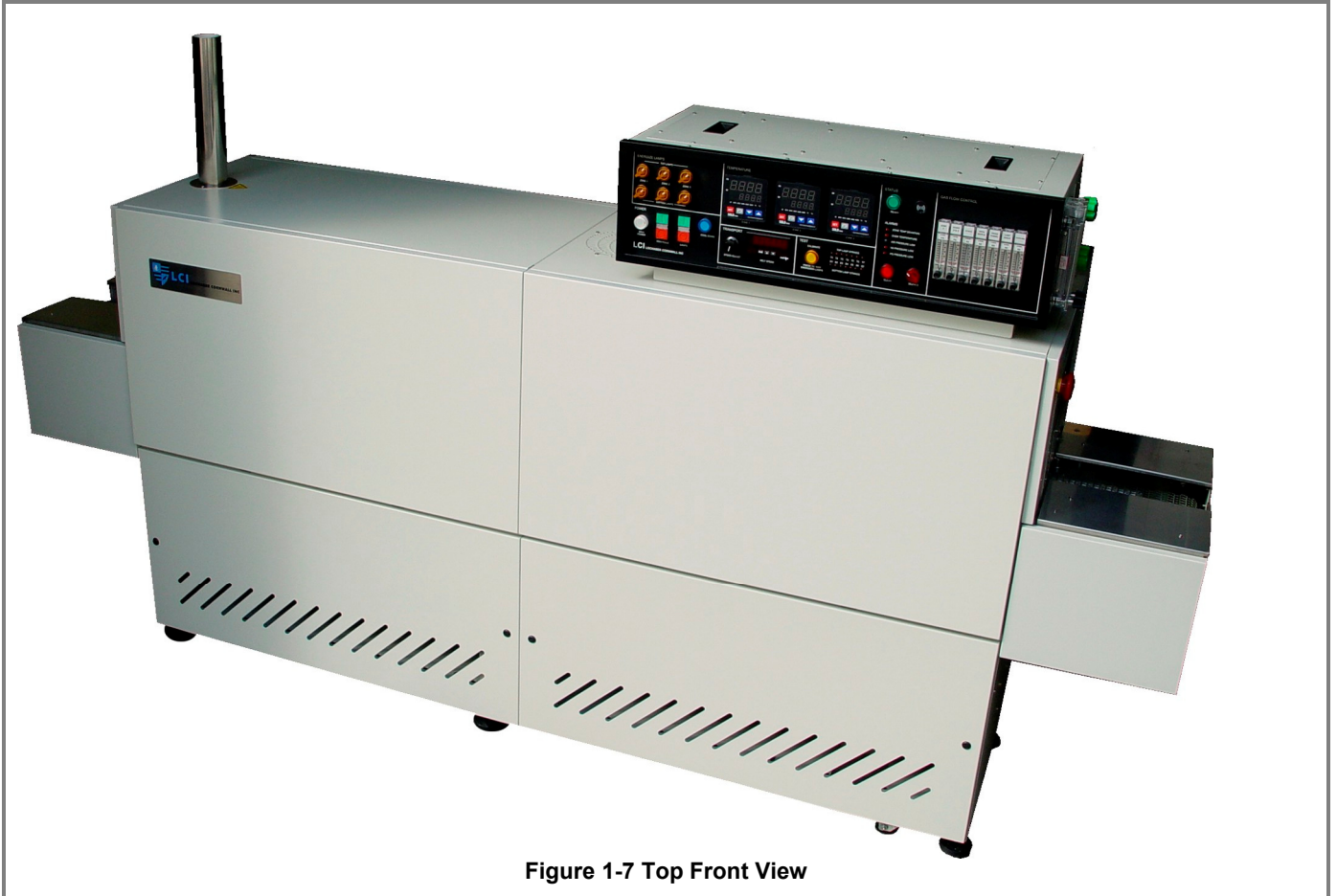

Figure 1-7 Top Front View

1.3 Thermal Process Elements

During furnace operation, parts are carried from the load station through the heating and cooling sections of the furnace to the unload station on a 152 mm (6-inch) wide belt driven by an adjustable speed motor. Maximum vertical parts clearance inside the standard furnace is 50 mm (2 inches).

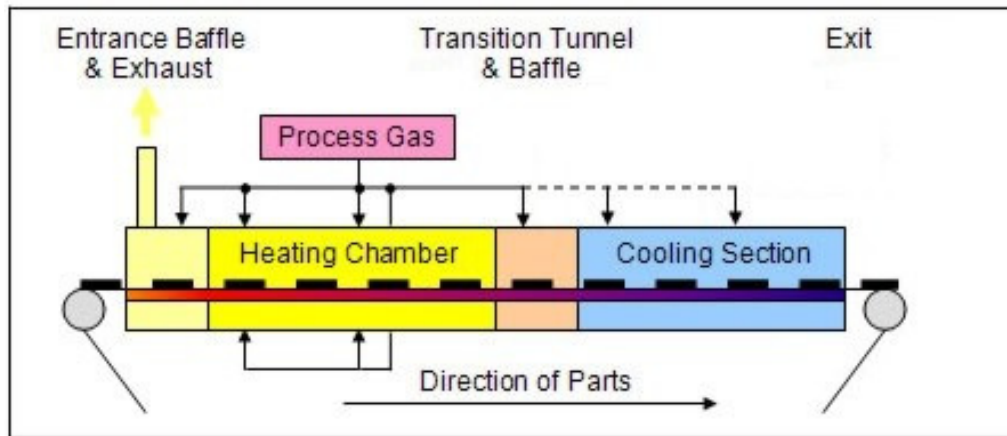

Figure 1-8 Process Sections

Process atmosphere is controlled much like a clean room: pressurized gas is pushed through the heating chamber insulated walls providing pre-heated, laminar flow for a uniform, stable atmosphere.

Zones. The heating chamber is divided into 3 zones separated by insulating dividers so that adjacent zones can maintain different setpoint temperatures, if required. Control starts with K-type thermocouples in each zone quickly sensing changing conditions and feeding these signals to individual digital PID controllers for each zone. The PID loop controllers drive arrays of IR quartz heating lamps inside the heating chamber so as to maintain the desired temperature setpoint in each zone.

Product cooling is by radiant cooling and CDA or N₂ gas convective cooling in an enclosed tunnel, with exterior fan heat removal.

1.4 Heat Transfer Methods

Transfer of heat in the furnace is by three different methods: Radiation, Convection and Conduction. In order of their contribution to heating the product, these methods are:

A. Radiation

The furnace lamps emit infrared electromagnetic waves which, when striking and absorbed by product on the belt, cause its temperature to rise. “Heat lamps” and microwave ovens work in a similar manner and it is also the way the sun heats the Earth. The infrared radiation does not directly heat the process gas within the furnace.

B. Convection

During operation, lamp radiation heats the chamber top, bottom and side wall insulation. As the process gas enters the furnace through the porous ceramic insulation, it is heated to near the setpoint temperature of the zone. This flow of heated gas transfers heat to the product on the belt. Hair dryers and home forced air heating function in the same fashion.

C. Conduction

Lamp radiation heats the transport belt which becomes a heat source for the product supported on the belt. Electric stoves and hot plates heat in this way.

1.5 Controlled Atmosphere

LCI furnaces are equipped with the ability to supply constant streams of a supplied process gas. This feature allows the user to reduce product oxidation or contamination, remove process effluents or reduce other potentially negative effects of ambient air at high temperatures.

A controlled atmosphere also helps establish higher consistency in thermal processes. When a product travels through the process section, slight changes in the atmospheric conditions in a non-controlled atmosphere environment can affect the stability and consistency of the product temperature profile.

1.6 Hermetically Sealed Systems

For most furnace systems, the lamps ends are enclosed in plenums. Gas fed to the plenums keeps the lamps cool and prolongs the life of the lamp and improves lamp IR performance. Balancing the furnace gas inflows and outflows enables the furnace to maintain a hermetic seal. While not air-tight, a hermetic seal resists the mixing of the outside atmosphere with the furnace atmosphere by maintaining a higher pressure inside the furnace chamber.

1.7 Furnace Process Equipment

The furnace process equipment includes an entrance baffle with an eductor equipped exhaust stack, a heating chamber, a transition tunnel between the heating and cooling sections, and a closed atmosphere cooling tunnel, configured for 50mm (2-inch) product height (PH2) and arranged as shown in Figure 1-9 (see Chapter 6, PH1 and PH4, for optional product height choices). Together, the individual sections function together to provide a carefully controlled gas atmosphere, precise temperature profile and two-stage controlled atmosphere cooling.

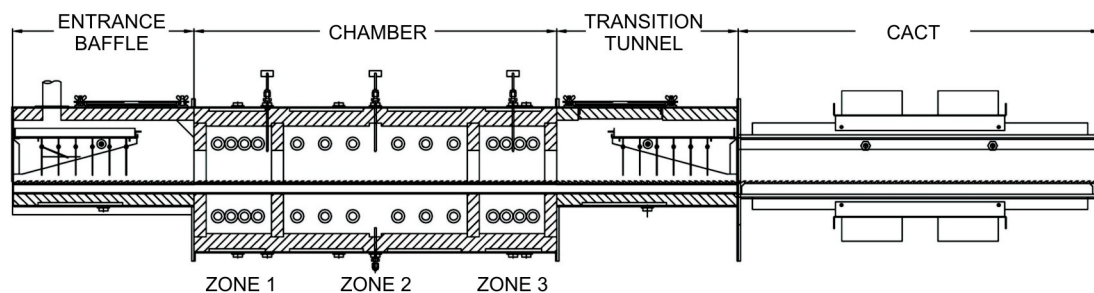

Figure 1-9 Furnace Internals

1.8 Load Station (LOAD)

Located immediately before the furnace entrance, the Load station consists of two (2) horizontal stainless steel surfaces 370 mm (14.5 inches) long x 206 mm (8.125 inches) wide positioned on either side of the belt. The Load station provides a convenient area for handling product and for holding profiling equipment. Extensions in multiples of 380 mm (15 inches) can be added to increase the length of the Load station.

1.9 Entrance Baffle & Exhaust Stack (BE)

The entrance baffle isolates the heating section from the ambient air outside the furnace entrance. It is housed in a welded stainless steel shell lined with ceramic fiber insulation. An N_2 or CDA gas curtain with a series of hanging stainless steel baffle plates serves to act as a thermal barrier as well as purge the baffle and help prevent ambient air from entering the furnace. Owner can stipulate baffle clearance of 6 mm to 40 mm (0.25 to 1.5 inches) above the belt (or eliminate entirely). Adjust gas flow to the ENTR BAFFLE flowmeter to isolate Zone 1 from room atmosphere.

A venturi-assisted exhaust stack, or “eductor”, draws furnace gases out of the furnace. Before exhausting via the stack, the process gas passes over a removable drip tray to collect exhaust condensation and prevent it from falling into the baffle section and contaminating the product. The eductor pulls 10-15 times its process gas flow from the furnace. Adjust gas flow to the STACK flowmeter to balance the furnace gas outflow with the gas inflow.

1.10 Chamber

The furnace chamber is similar in construction to the entrance baffle and is usually hermetically sealed with plenum covers over the lamp ends. Inside this section, arrays of tungsten filament quartz heating lamp tubes located above and below the belt, generate intense near-wave (sometimes called “short-wave”) infrared light with a color temperature of 2500 K (peak wave length of 1.16 μm). These lamps are very efficient heaters with very fast response times, producing up to 600 W per lamp at full power and capable of heating the furnace chamber to a state of equilibrium within minutes.

Lamp Arrangement. The lamps are arranged symmetrically above and below the belt. The top and bottom lamps may be used independently or together to configure the best possible heat transfer mode for each individual process. **Table 1-1 Furnace Arrangement** shows the distribution of lamps and available power in each zone.

Table 1-1 Furnace Arrangement					
Zone	Length (mm)	# of Lamps Top / Btm	Lamp Spacing (mm)	Standard Furnace Max. Available Zone Power (W)	High Power Furnace Max. Available Zone Power (W)
1	190	4 / 4	30	4800	4800
2	380	6 / 6	58	3800 – 4800*	7200
3	190	4 / 4	30	4800	4800

*Depends on line voltage; 208 Vac: 3800W; 220 or 380 Vac: 4200W; 230 or 400 Vac: 4500W; 240 or 415 Vac: 4800W

Standard and High Power Configurations. LA-306 furnaces are wired in standard configuration or high power configuration. In the standard configuration Zones 1 and 3 are wired with two (2) parallel strings, each consisting of two (2) lamps in series. Zone 2 is wired with two (2) parallel strings, each string consisting of three (3) lamps in series. High power models differ only in Zone 2 which is wired with three (3) parallel strings, each string consisting of two (2) lamps in series. Either model will perform well throughout the design temperature range of the furnace (100-1000 $^{\circ}\text{C}$), the standard model is optimized for 100-800 $^{\circ}\text{C}$ operation, while the high power model is optimized for 500-1000 $^{\circ}\text{C}$ operation. Lamps within the furnace are arranged as shown in Table 1-2.

Table 1-2 Furnace Lamps Wiring Configuration					
Zone	Standard Configuration		High Power Configuration		Total Number of Lamps
	Strings Top/Btm	Lamps per String Top/Btm	Strings Top/Btm	Lamps per String Top/Btm	
1	2 / 2	2 / 2	2 / 2	2 / 2	8
2	2 / 2	3 / 3	3 / 3	2 / 2	12
3	2 / 2	2 / 2	2 / 2	2 / 2	8

Zones. The heating chamber is partitioned into 3 separate zones using ceramic fiber dividers. The dividers are designed with the smallest possible opening consistent with the parts clearance specifications. This partitioning assures very high thermal isolation between zones. Although the heating profile across the belt is extremely uniform, heat losses through the furnace side walls and at the belt edge supports produce a temperature drop near the edges of the transport belt. Away from the extreme edges of the belt, overall temperature uniformity across the belt is normally better than $\pm 3^{\circ}\text{C}$.

Temperature Measurement. Inside the furnace chamber, at the top center of each zone a type K thermocouple measures the temperature in that zone and provides feedback to each respective zone PID controller to determine the amount of power necessary to maintain setpoint temperatures. However useful these thermocouples are for controlling the temperature in each zone, the actual part is exposed to three heat transfer methods. As with any furnace, the most accurate way to determine what temperature product on the belt actually sees from these three methods of heating is to profile the furnace with a thermocouple placed directly on the product surface.

Chamber Process Gas. Process gas (CDA, N₂, FG or other gas) is preheated before reaching the furnace interior by allowing it to permeate through the hot porous ceramic fiber insulation. This method of gas distribution improves furnace IR behavior and helps keep the furnace interior clean.

Zones: Adjust ZONE 1 and ZONES 2&3 flowmeters to keep the lamps ON as long as possible and to control the process atmosphere.

Plenums: Process gas (CDA, N₂, FG or other gas) is introduced into the chamber sides via 4 plenums, two on each side of the chamber, one top and one bottom. The process gas passes around the lamps into the chamber through high temperature fiber seals surrounding the lamp diameter as it passes through the chamber insulation. This gas serves to cool the ends of the lamps to prolong lamp life and also prevents the chamber atmosphere from leaking out of the furnace. Control gas to the sides of the chamber via the LAMP SEALS flowmeter. Maintain at least 12 Lpm flow to the LAMP SEALS to prevent damage to the lamps. Increase LAMP SEALS gas flow 2.5 Lpm for each 100°C the furnace is operated above 400°C to prolong lamp life

1.11 Transition Tunnel (TT)

The transition tunnel separates the furnace chamber from the closed atmosphere cooling tunnel. The transition tunnel is constructed using the same materials as the furnace section to minimize thermal stresses to the product caused by excessive cooling rates. Convective gas cooling of product is produced by the controlled flow of process gas into this tunnel via gas rakes. Hanging stainless steel baffle plates act as a thermal barrier and help contain the furnace heating and cooling atmospheres in their respective sections. Owner can stipulate baffle clearance of 6 mm to 40 mm (0.25 to 1.5 inches) above the belt (or eliminate entirely). Adjust TRANS TUNNEL flowmeter to control product initial temperature drop and to isolate the furnace atmosphere from the cooling section.

1.12 Cooling Tunnel (CACT)

The closed atmosphere cooling tunnel (CACT) is a 76 mm (30 inch) long high efficiency heat exchanger that reduces the temperature of the product on the belt as it passes through. It is constructed of extruded aluminum heat sink material and is not insulated. Inside, a carefully controlled atmosphere of CDA or N₂ gas is maintained to cool the product to a safe temperature. Fans mounted on the exterior of the CACT transfer heat to the air inside of the furnace cabinet. This cabinet air is then exhausted by cabinet fan through an opening in the furnace top cover into the room or for removal by facility exhaust ducting.

To inhibit drafts and ambient air from entering the CACT, a hanging stainless steel baffle plate is mounted directly to the CACT exit. Adjust gas flow using the COOLING flowmeter to isolate the transition tunnel from room atmosphere and to control product cooling rate. For operation of the furnace above 200 C assure that the COOLING flowmeter allow at least 8 Lpm gas flow. Increase COOLING flow at least 2.5 Lpm or more for each 100°C Zone 3 is operated above 200°C to prevent overheating the CACT cooling chamber.

To inhibit drafts and ambient air from entering the CACT, a hanging stainless steel baffle plate is mounted directly to the CACT exit. Adjust gas flow using the COOLING flowmeter to isolate the transition tunnel from room atmosphere and to control product cooling rate.

1.13 Unload Station (UNLOAD)

Located immediately after the furnace cooling section exit, the Unload station consists of two (2) horizontal stainless steel surfaces 370 mm (14.5 inches) long x 206 mm (8.125 inches) wide positioned on either side of the belt. The Unload station provides a convenient area for handling and inspection product exiting the furnace and for product removal. Extensions in multiples of 380 mm (15 inches) can be added to increase the length of the Unload station.

1.14 Console Controls & Indicators

1.14.1 Control Console

Interface with the furnace is via the Control Console (Figure 1-10) mounted over the cooling section of the furnace. The Control Console is divided into 7 logical panels: Power panel, Energize Lamps panel, Temperature panel, Transport panel, Test panel, Status panel and Gas Flow Control panel. The Control Console is used to communicate with the programmable logic controller (PLC), housed within the Control Enclosure, that controls furnace operation.



Figure 1-10 LA-306 Control Console

1.14.2 POWER Panel

A. MAIN POWER lamp

Indicates connected power. When this WHITE light is ON, the furnace is connected to the power line.

B. CONTROLS pushbuttons with indicator

Switches power to the furnace control system.

Pressing the green switch applies power to the furnace controls, belt motor and cooling fans.

Pressing the red switch shuts off power to the furnace and acts electrically in the same way as pushing an EMO button.

Between the switches is an indicator light that stays ON while the control system is ON.

C. LAMPS pushbuttons with indicator

Switches power to selected heating elements. These buttons work only when CONTROLS indicator is ON.

Pressing the green switch applies power to the lamps.

Pressing the red switch shuts off power to the lamps.

Between the switches is an indicator light that stays ON while the lamps are ON.

D. COOL DOWN pushbutton with lamp

Starts Cool Down cycle. Pressing this button begins a controlled cool down sequence. The furnace lamps shut down immediately, but the Cool Down circuit keeps the zone controllers, transport belt and cooling fans ON to help cool the furnace until one of these conditions occurs:

1. All zones cool to below 100°C
2. 120 minutes have passed
3. The operator pushes the red CLEAR pushbutton.

While in COOL DOWN, the blue indicator in the pushbutton remains lit until the Cool Down condition is met, then the blue light turns OFF.



Figure 1-11 Power control panel

COOL DOWN can be cancelled using the CLEAR button on the Status panel.

Cool Down – Auto Shut Down. After starting COOL DOWN, if the operator then presses the red CONTROLS button, the cooling cycle will continue as above, except that after the cooling cycle is complete, all controls, displays, the PLC and the furnace shuts off completely.

1. Auto Shut Down mode may be **cancelled** at any time by first pressing the CONTROLS pushbutton ON and then pressing the CLEAR pushbutton on the Status panel.
2. In an **emergency** during Auto Shut Down mode, pressing any EMO button shuts off the PLC and the furnace completely.

1.14.3 ENERGIZE LAMPS Panel

A. Zone Selector Switches with Lamps

Each switch turns the respective top or bottom heating elements in the designated zone ON or OFF. When a switch is turned CW, those elements are selected to be ON and the switch light turns ON. Turning a lighted switch CCW turns those elements OFF.

Selected zones remain selected even when furnace power is OFF.



Figure 1-12 Energize Lamps control panel

NOTE: Change zone selection only with LAMPS OFF to maximize zone selection switch life.

1.14.4 TEMPERATURE Panel

Controls Zone Temperature. Independent control of each furnace zone is provided by type K sensing thermocouples, located above the belt in each zone, coupled to digital temperature controllers that regulate the power output of the lamps and sense alarm or alert conditions in each zone. The behavior of the furnace zone heating elements is controlled via these sophisticated PID temperature controllers (Figure 1-13).



Figure 1-13 Zone Temperature Controllers

Each zone controller is a digital single-loop PID controller with loop Autotune and three alarm functions. The controller's closed loop temperature control system uses K-type thermocouples for feedback. For each zone, four individual PID models are independently optimized to provide excellent furnace performance throughout the 100-1000°C operating range of the furnace. The zone controllers automatically select the PID control model closest to the target setpoint. Zone temperature controller indicators and controls are illustrated in Figure 1-14.

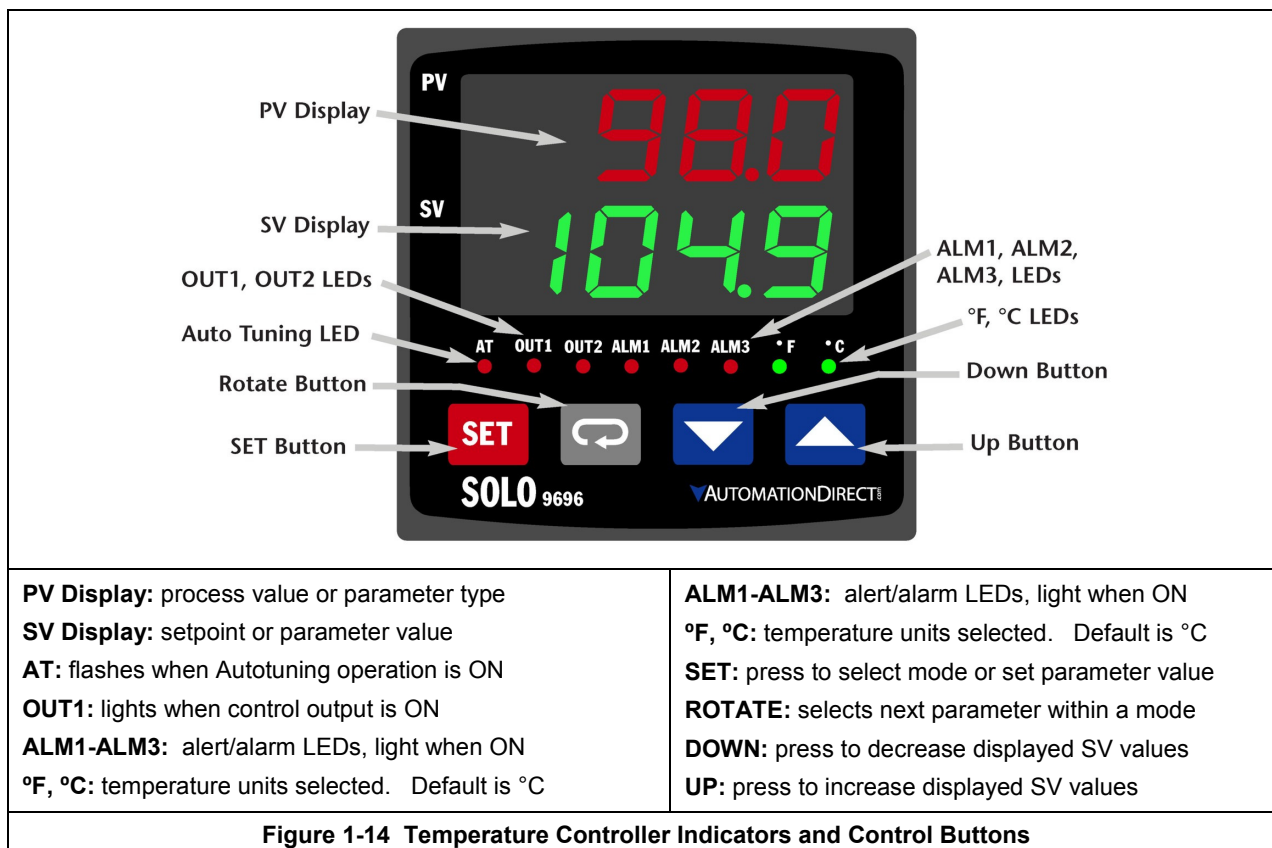

Figure 1-14 Temperature Controller Indicators and Control Buttons

1.14.5 TRANSPORT Panel

A. SPEED ADJUST Knob

Sets belt speed setpoint. The Transport Speed Adjust knob enters the belt speed setpoint. CW rotation increases speed, CCW rotation decreases speed setpoint. Fine tuning is possible with roughly 10 turns between minimum and maximum speed.

B. CALIBRATE light indicator

The Calibrate indicator light illuminates whenever the SPEED ADJUST knob is being turned or the SPEED ADJUST system is in MANUAL MODE.

C. BELT SPEED Indicator

Displays belt speed. The digital display meter shows belt speed in inches per minute (ipm), millimeters per minute (mm/m), centimeters per minute (cm/min), or other custom units of rate.

The **PAR**, **▼** and **▲** are only used to change the display parameters and are normally disabled during furnace operation.

D. SPEED ADJUSTMENT & CONTROL

On furnace startup the stored belt speed is retrieved from the PLC memory and the belt transport system will settle at this speed within 90-120 seconds.

Normal operation. During normal operation, the belt speed is automatically controlled by the furnace controller to a setpoint determined by the user. Turn the SPEED ADJUST knob to set or change the belt speed setpoint to a value above the furnace specification minimum speed. Stop turning when the desired setpoint appears in the BELT SPEED display. During adjustment, the CALIBRATE light turns ON indicating the setpoint is being changed (Figure 1-16). The BELT SPEED display is updated every 3 seconds, so there is a short delay in seeing the effect of your adjustment. Release the knob and after 10 seconds press the red CLEAR button. The currently displayed belt speed will be stored as the new setpoint and the CALIBRATE light will turn OFF.

During the next 60 seconds or so, the BELT SPEED display will fluctuate as the controller refines its control of the belt motor's speed to the new setpoint. (Note: before again adjusting the knob, allow the controller some time to properly settle the belt motor at the new speed.) Once the lock is established, that belt speed setpoint will be maintained by closed-loop (feedback) control until the user turns the SPEED ADJUST knob, initiates MANUAL MODE, or presses the CONTROLS OFF pushbutton.

Manual mode. In MANUAL MODE, the belt speed lock (feedback control) is disabled and the SPEED ADJUST knob input directly controls the belt speed (feed-forward control). To enable MANUAL MODE,

1. Press and hold the CALIBRATE pushbutton for 3 seconds, and then release. Both the CALIBRATE and CLEAR light indicators will illuminate and remain lit until MANUAL MODE is cancelled.
2. As in normal operation, adjust belt speed using the SPEED ADJUST knob; the BELT SPEED display is updated every 3 seconds, so there is a short delay in seeing the effect of your adjustment. The belt speed may fluctuate slightly or drift over time in this mode. Keep in mind there is a 3-second delay in belt speed display update; it may take several iterations of this delay interval until the display settles at the value you selected. (Note: holding pushbutton for less than 3 seconds will initiate the SCR calibration process with rapidly rising zone temperatures. If this happens, immediately press the CLEAR pushbutton on the Status panel to cancel the SCR calibration process.)

To cancel MANUAL MODE, press the CLEAR pushbutton on the control console and you will return to normal operation (feedback control) as described above. The belt speed displayed at the moment the CLEAR pushbutton is pressed will be stored as the new belt speed setpoint to a value above the furnace specification minimum speed. CALIBRATION light stays ON until controller locks on the new speed setting. Belt speed will oscillate slightly for a moment until it begins controlling to the new setpoint.

The MANUAL MODE is useful for calibrating or servicing the belt transport system, or as an alternate way to set your desired belt speed.



Figure 1-15 Transport Panel

BEST PRACTICE: Belt speed may be changed at any time whether the lamps are ON or OFF. However, for best practice:

1. Before lamps are turned ON, set the control system to Manual by pressing CALIBRATE button for 5 seconds,
2. Adjust SPEED ADJUST knob until proper belt speed is displayed.
3. Display will fluctuate, press CLEAR button immediately when desired speed is displayed to lock in the value.
4. Let the belt speed settle 2-3 minutes before pressing Lamps ON button.

1.14.6 TEST Panel

A. CALIBRATE pushbutton

Starts lamp string test and calibrate SCR cycles.

Whenever the LAMPS button is ON, 25% power is applied directly to the lamps selected on the ENERGIZE LAMPS panel, allowing a reliable check for failed lamps using TOP and BOTTOM LAMP STRING indicators, or to adjust the SCR line voltage settings during SCR maintenance.

The CALIBRATE mode ends automatically after 2 minutes. Pressing the CLEAR button ends the CALIBRATE mode immediately. Lamp (SCR) control is then returned to the zone controllers.

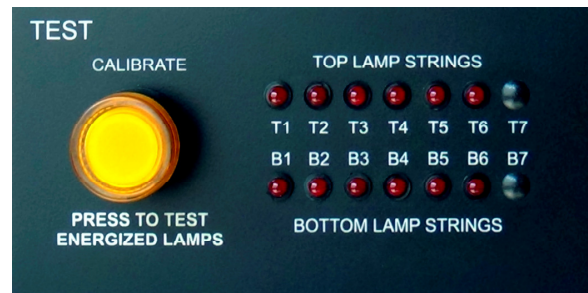

Figure 1-16 Test Panel

B. TOP LAMP STRINGS and BOTTOM LAMP STRINGS indicators

Failed lamp indicator displays lamp string current flow. A lamp “string” is 2 or 3 IR heating lamps wired in series to maximize each lamp’s efficiency. Whenever the LAMPS button is ON and current is flowing to the energized zone, corresponding furnace TOP lamp strings T1 through T7 above the belt, and BOTTOM lamp strings B1 through B7 below the belt are continuously monitored for lamp failure. Strings T1&B1 are closest to the furnace entrance, and T7&B7 are closest to the exit. See Figure 1-17 (for a Standard furnace) or Figure 1-18 (for High Power furnace) for correlation of lamp strings to zones.

During normal operation, if an indicator is lit, the lamps in the string are fine. If unlit, the commanded power may be too low or OFF for an accurate assessment (a condition most likely during actual operation of the furnace); one of the lamps in that string may have failed; or the string may not be in the group of lamps selected on the ENERGIZE LAMPS panel. For a more definitive assessment, use the CALIBRATE mode to check the lamps before running product in the furnace or during maintenance checks.

Lamp Strings by Zone. LEDs that should be lit for each zone are indicated in Figure 1-17 and Figure 1-18. In each zone, all TOP and all BOTTOM LEDs, if energized, should be lit at the same time. If only one LED in a zone does not light it indicates the lamp string may contain a failed lamp or loose wire.

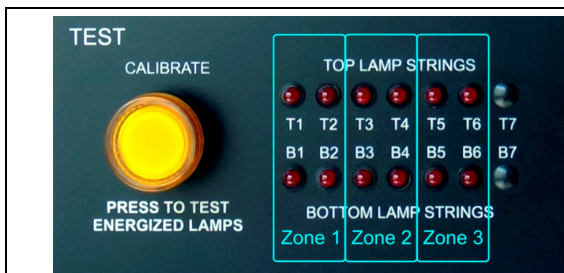

Figure 1-17 Zone Lamp Strings–Standard

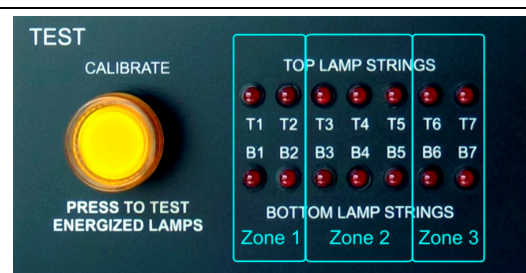

Figure 1-18 Zone Lamp Strings–High Power

1.14.7 STATUS Panel

A. READY lamp

Indicates the furnace is ready to process parts. After all zones have heated to their SV setpoint values and the controllers have reported all PV process temperatures as within process ready limits for 2 minutes, the process READY light (green) on the STATUS panel will turn ON.

B. BUZZER

Audible warning. Broadcasts an audible signal alert or alarm conditions.

C. ALARMS

Indicates the condition that caused an alert or alarm. An alert condition will only produce an audible and visual warning. An alarm condition will produce an audible and visual warning and immediately shut off the lamps. Any alert or alarm condition will shut off the READY Lamp. LED indicators stay lit until CLEAR is pressed.

D. ZONE TEMP DEVIATION alert indicator

Lights when a zone has experienced a process temperature outside the setpoint temperature (ALM1) limits set in the zone controller. Factory setting is +/- 10°C.

E. OVER TEMPERATURE alarm indicator

Lights when a zone has experienced a process temperature higher than the maximum limit (ALM2) set in the zone controller and the lamps have been turned OFF. Factory set to 1005 °C.

F. AIR PRESSURE LOW alert indicator (optional)

Lights when the CDA (clean, dry air) gas manifold has insufficient gas pressure, effecting operation. Factory set to 55-60 psi.

G. N2 PRESSURE LOW alert indicator (optional)

The N2 (nitrogen) gas manifold has insufficient gas pressure, effecting operation. Factory setting to 55-60 psi.

H. FG PRESSURE LOW alert indicator (optional)

On dual Gas Systems only, this lamp indicates the furnace chamber manifold has insufficient FG (forming gas, H2/N2 mix) pressure.

If system is equipped with GSM (Supply Gas Mixing system), this alarm indicates the furnace manifold gas selected at the GSM is low, effecting operation. Factory set to 55-60 psi.

I. CLEAR pushbutton with lamp

Indicates and clears alerts, alarms; also halts CALIBRATE and COOL DOWN modes, and stores presently displayed belt speed in PLC memory when in belt speed Manual Mode. Red lamp lights on any alert or alarm condition or any condition that can be cleared (including Calibrate and Cool Down cycles). Press the button to:

1. Clear all alerts and alarms, and will
2. Immediately cancel the CALIBRATE or COOL DOWN function, if active.

Continuing alert and alarm conditions will re-light the lamp, however, so it is best to correct the cause of the alert or alarm condition before pressing the CLEAR button.

J. SILENCE switch with red lamp

Silences buzzer. Turn the SILENCE switch CW to silence the buzzer. This will also turn the SILENCE red lamp ON as a reminder to the operator that the buzzer is disabled.

Silencing alerts is useful when changing setpoint temperatures, calibrating the SCRs, or auto tuning a zone.

Turning the lighted SILENCE switch CCW will enable the audible buzzer and turn the SILENCE lamp OFF.



Figure 1-19 Status Panel and Alarm Controls

1.14.8 GAS FLOW CONTROL Panel

Indicates and controls Process Gas flow. Atmosphere control is adjusted manually using needle valve flowmeters which control gas flow to the various parts of the furnace and out the exhaust stack in order to achieve overall gas flow balance within the furnace. The flowmeters are graduated in liters per minute. Meter arrangement may vary depending whether the furnace is a single or dual gas configuration (See Figure 1-20 and Figure 1-21).

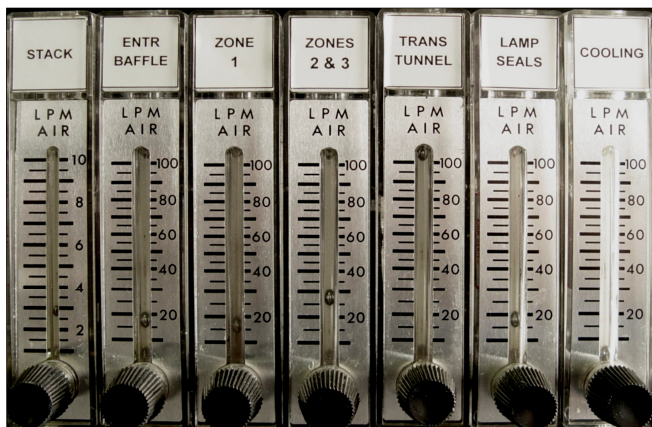

Figure 1-20 Gas Flowmeters - Single Gas



Figure 1-21 Gas Flowmeters - Dual Gas

Each flowmeter is identified with a label as to specific function and is adjustable from zero flow to full scale by means of a needle valve control knob. Turning this knob CW decreases flow; CCW increases flow. Flow is read on the graduated scale at the mid-point of the bead. Standard flowmeters include:

A. STACK

Controls flow to the exhaust stack venturi. Stack flow has the capacity to exhaust from the furnace atmosphere a volume 15 times the flow setting (for example, 5 L/m Stack flow removes 75 L/m of furnace atmosphere).

B. ENTR BAFFLE

Controls flow to the entrance baffle isolating the furnace from room air.

C. ZONE 1

Controls flow to furnace chamber zone 1.

D. ZONES 2 & 3

Controls flow to furnace chamber zones 2 and 3.

E. TRANS TUNNEL

Controls flow to the transition tunnel isolating the heating chamber and cooling chamber from one another.

F. LAMP SEALS

Controls flow to the sealed lamp plenum boxes on each side of the furnace heating chamber.

G. COOLING

Controls flow to the CACT closed atmosphere cooling tunnel gas rakes.

For furnaces equipped with a SEALS flowmeter, to prevent damage to the element seals and avoid premature lamp failure:

- When operating at 400 °C or below, set the SEALS flowmeter to at least 12 L/min.
- When operating above 400 °C, increase flow a minimum of 2.5 L/min for each 100°C the furnace is operated above 400 °C.

To prevent damage to the CACT aluminum heat exchanger:

- When operating at 200 °C or below, set the COOLING to suit process parts cooling requirements.
- When operating above 200 °C, set COOLING to a minimum of 8 L/m (for 200°C in Zone 3) plus 2.5 L/min per 100°C above 200°C to protect CACT or higher to suit process parts cooling requirements.

1.15 Programmable Logic Controller (PLC)

The furnace is controlled by a programmable logic controller or PLC. The PLC is a compact expandable high speed microcomputer. Basic input and output functions (I/O) are managed by the PLC including alert and alarm signals, sensors and ready status. The PLC on each furnace may vary according to installed features and options.

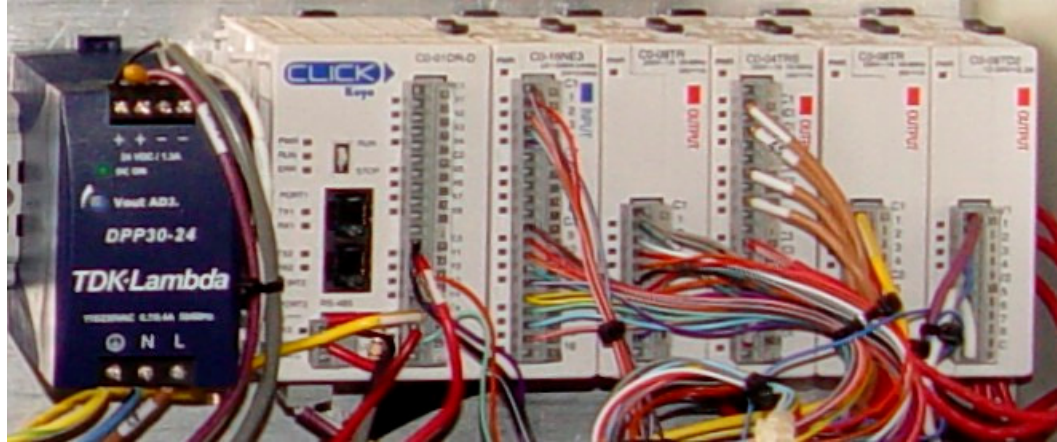

Figure 1-22 PLC and Power Supply

The PLC generally consists of a CPU module and a number of digital and analog input and output modules. The CPU is the central processing unit or controller and contains the furnace program. The input modules receive signals from the furnace indicating its operating state. After processing the input information, the CPU sends instructions to the furnace via the output modules causing the ready light to come on or an alarm to sound. The PLC contains non-volatile FLASH ROM memory to store the factory installed program.

The CPU Contains Status indicators, communication ports and a PLC mode switch. See Section 7.6.2 for information on using the status lights in troubleshooting.

The PLC mode switch must always be in the RUN position to operate the furnace.

Port 1 is an RS-232C programming port.

The PLC (and the furnace) operates only when the CONTROLS pushbutton is ON. Pressing any EMO button or pressing the CONTROLS pushbutton OFF shuts off the PLC and the furnace.

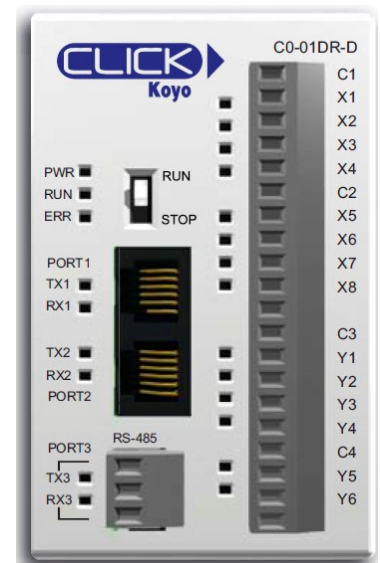

Figure 1-23 PLC CPU

1.16 Furnace Auxiliary Equipment

1.16.1 Cabinet Fans

Cabinet Fan. The furnace is equipped with one (1) 10-inch diameter fan mounted on the underside of the top of the furnace cabinet. This fan exhausts heat emitted from the outside of the furnace chamber and cooling tunnel into the room or customer installed exhaust system.

Enclosure Fan. The control enclosure is cooled by fan(s) mounted under the enclosure. These fans pull cool air from the room into the enclosure through vents in the enclosure base. The air is forced into ports in the back panel, across heat sinks where SCR's are mounted, and exhausts out of the top of the rear door panel.

Cooling System Fans. The exterior of the CACT cooling tunnel is cooled by fans mounted on the top and bottom of the tunnel. Cabinet air forced over the cooling tunnel removes heat conducted from the tunnel interior. This air is evacuated via the cabinet fan.

1.16.2 Low Pressure Alarms (IPS)

Gas Supply Pressure Switches are installed on the process gas manifolds. These switches are normally closed. They open when proper pressure is present in the process gas supply lines.

The pressure switches are factory set to open when pressure falls below the pressure set points in Table 1-3 for Gas 1 and Gas 2.

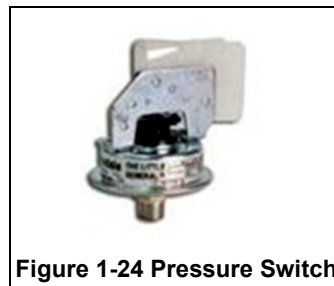

Figure 1-24 Pressure Switch

Table 1-3 Initial Pressure Alarm Settings			
Manifold	Process Gas	Pressure Set Points	
Gas 1	Nitrogen or CDA	55-60 psi	3.8-4.1 Bar
Gas 2	Nitrogen, Forming Gas or other (Dual Gas option only)	55-60 psi	3.8-4.1 Bar
Gas 2	Hydrogen (H ₂ option only)	55-60 psi	3.8-4.1 Bar

The pressure switch set points can be adjusted manually. Locate the switch in the process gas supply line. To increase the set point turn the wheel clockwise. Turn the top of the switch counter clockwise to decrease the pressure set point so the alarm will not occur until the pressure drops to a lower point.

1.16.3 Belt Travel (LTR)

Standard direction for belt travel is from left to right when facing the furnace Control Console. As an option, the furnace can be configured for right to left operation (See section 6.19 for LTR and RLT plan view).



1.16.4 Transport Belt

The standard LA-306 standard conveyor belt is designed for high temperature applications. The belt is a close weave design manufactured from high temperature Nichrome-V wire, comprised of 80% nickel and 20% chromium. This belt offers fast heat-up times, more uniform operating temperatures and excellent mechanical stability. It also exhibits minimum shrinkage, growth, sag or distortion in use.

For some low temperature applications (under 500 °C) a stainless steel belt may be requested at a lower cost.

1.16.5 Transport Drive

A. Major Components

The major transport drive components are listed in Table 1-4 .

Table 1-4 Transport Drive Components								
Item	Brand	Model	Drive Speed	HP	Torque (in-LB)	Motor Voltage (Vdc)	Motor RPM	Gear Ratio
Controller	Minarik	PCM21010A	-	1/40-1/8	-	90		
Motor	Bison	011-336-2082	22 rpm	1/8	300	90	1760	81.8:1
Encoder	Automation Direct	TRD-NH30-RZWD	30 ppr	4.75-30 Vdc		90		

Note: Belt speed can vary depending on installed gearing.

B. Motor Controller

The motor speed is controlled by a variable speed SCR drive controller. When operated in the Manual Mode the motor controller uses the control panel-mounted potentiometer to scale output voltage to the motor. In the Normal (or automatic) Mode the PLC averages the pulse counts from the encoder and modifies the signal to the motor controller to maintain motor speed using a PID loop.

The motor controller is designed for 90 Vdc motor operation. The Motor controller is mounted in the furnace Control Enclosure. See Figure 1-25.

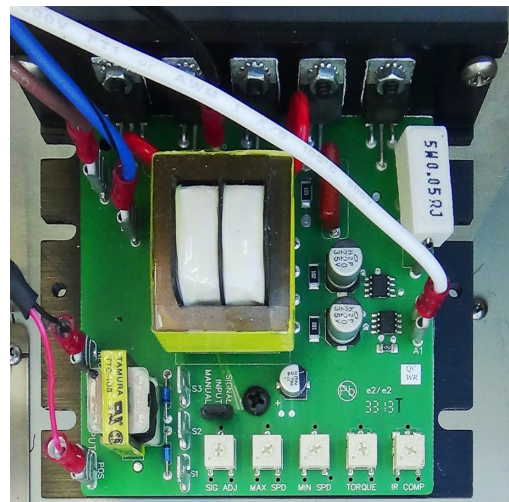

Figure 1-25 Motor Controller

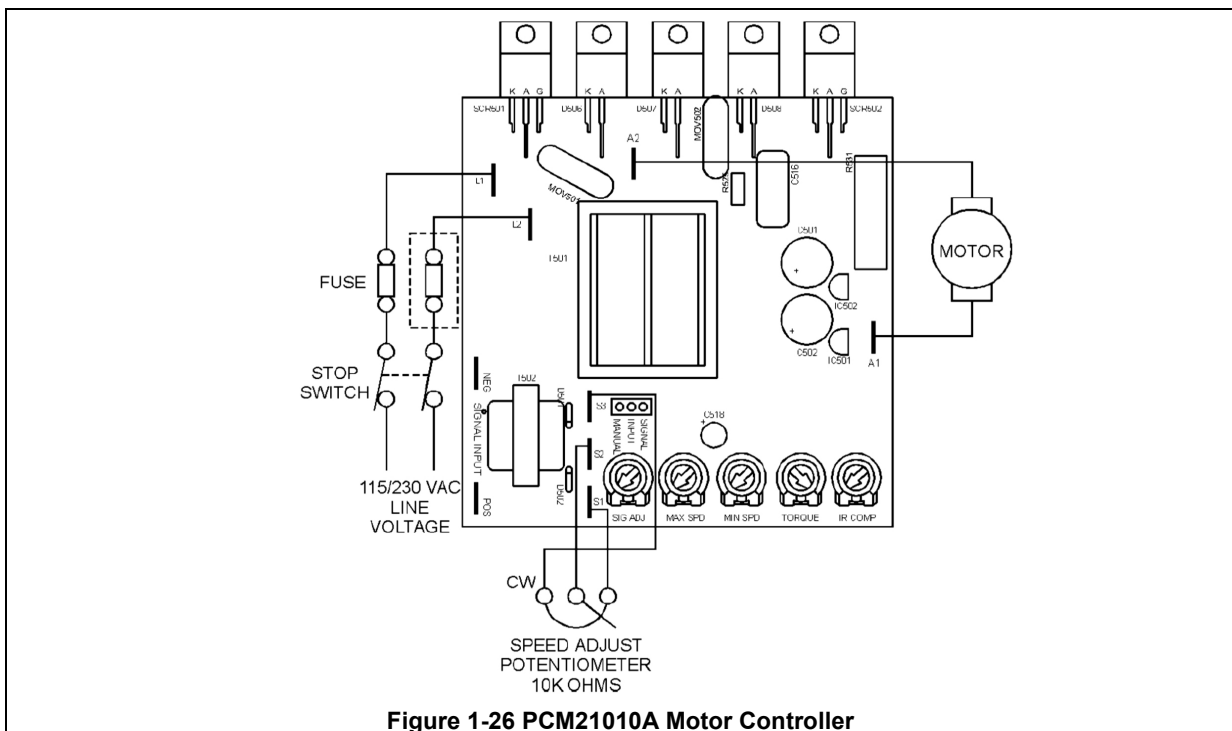

Figure 1-26 PCM21010A Motor Controller

C. Transport Drive Motor

The transport drive motor is a 1/8 HP TENV Brushless parallel shaft DC gearmotor and encoder assembly. The transport motor assembly is mounted in an enclosure at the exit end of the furnace. Drive chain and motor sprocket sized to provide the desired belt speed range shown in Table 1-4. The motor is shown in Figure 1-27 and Figure 1-28.



Figure 1-27 Drive Motor

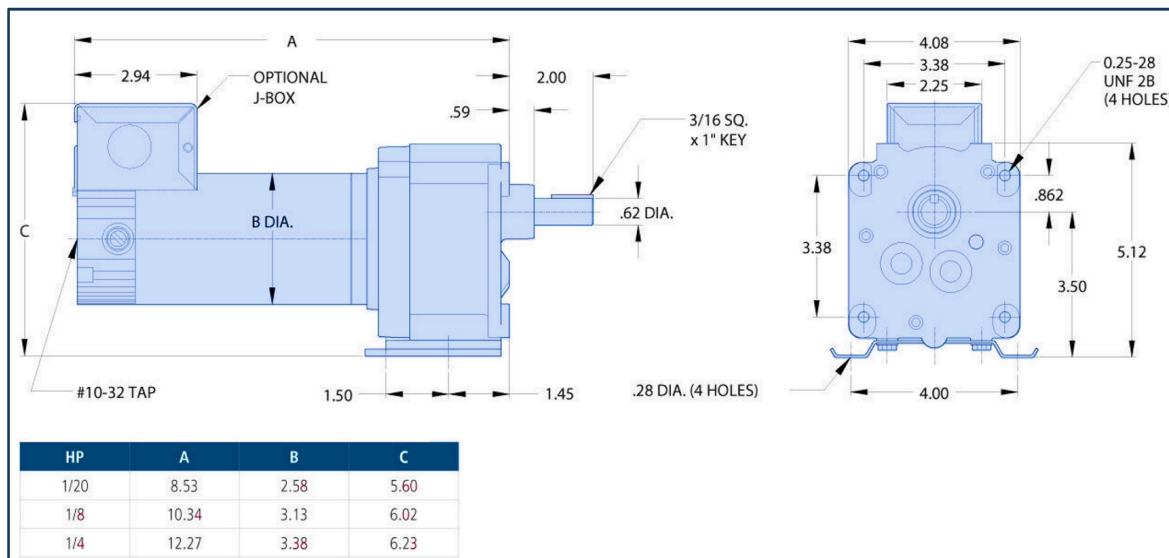

Figure 1-28 Transport Drive DC Motor

D. Speed Encoder

The motor is equipped with a 30 pulse per revolution dual channel 5-30 Vdc push-pull encoder (Figure 1-29). One channel is connected to the rate meter to report the belt speed, the other to the PLC to lock in the belt speed.

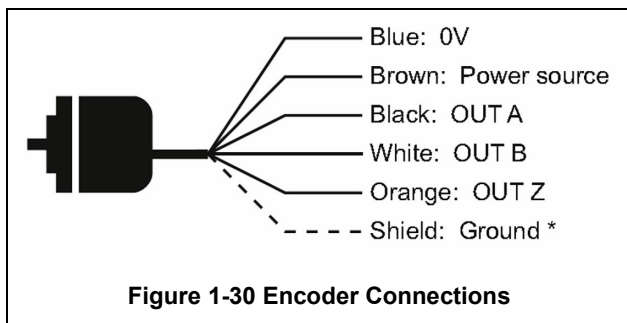

Figure 1-30 Encoder Connections



Figure 1-29 Encoder

1.16.6 Universal Transformers

All primary transformers used in the furnace are manufactured specifically for our furnaces. These transformers are 50/60 Hz multi-tap and can be configured to operate the furnace at most commonly available voltages worldwide.

Detailed steps for successful installation of an LA-306 furnace. Included both standard and optional equipment.

2.1 Unpacking the Equipment

2.1.1 Un-banding and Verification

Remove the banding from the shipping container and carefully disassemble. Refer to the sales order or your purchase order to verify the model of your furnace system and good receipt of all options, accessories, and special configurations, which were ordered according to the original purchase order or specification. If you cannot locate a listed item, immediately notify the carrier and Technical Support.

2.2 Location & Initial Installation Work

2.2.1 Machine Inspection

Remove the upper and lower side covers from both sides of the machine. Inspect all lamp connections for soundness and for loose hardware that may have become dislodged during shipment. Inspect the lower electrical compartment for shipping damage, loose connections, or components. Finally, inspect the furnace interior, checking for broken lamps, foreign objects, or any components that may have come loose during shipment. Report any shipping damage immediately to the LCI Furnaces or FurnacePros Technical Support Department.

2.2.2 Machine Label

The furnace label generally appears as in **Figure 2-1 Name Plate** and indicates the voltage, phase connected power and current. Actual operating values are much lower and can be found in Chapter 11 Specifications.

This label will normally be located near the Power Input either on the side or rear of the Control Enclosure.

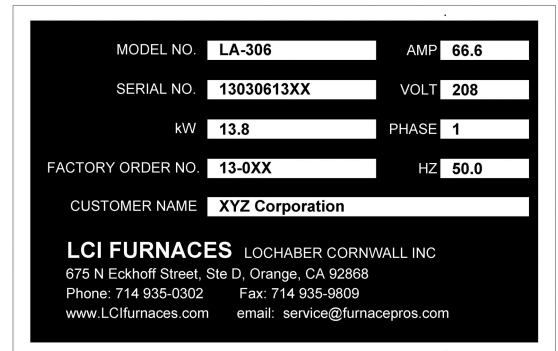

Figure 2-1 Name Plate

2.2.3 Machine Location

Furnace Environment Considerations. Location of the machine is important. The furnace environment should be clean and dry, especially if the furnace is to be used for to create low oxygen or other controlled environment. The lower the moisture levels in the room where the furnace is located, the easier it will be to achieve low oxygen and moisture levels in the furnace.

Locate furnace away from fans, blowers or other equipment or drafts that can influence atmospheric conditions inside the furnace.

Front & Rear Clearance. For best operator and service access, position furnace to provide a minimum of 36 inches clearance, front and rear, to the closest obstruction. If space is limited, you can reduce clearance at furnace rear to a minimum of 24 inches for normal operation, but must be able to move furnace to allow a minimum of 30 inches clearance for safe and proper access on both furnace front and rear.

Entrance & Exit Clearance. As long as the belt is not obstructed, you can place feeding and receiving equipment right at the entrance and/or the exit to facilitate loading and off-loading parts.

Installing Through a Wall. If installing the furnace through a wall between two rooms, make sure that the room pressures are equalized to avoid influencing the furnace atmosphere.

2.2.4 Lifting and Machine Placement

Locate the machine on an unyielding floor in the final installation position so that the access panels along the length of the furnace can be removed for calibration, servicing and maintenance. Lift the machine at the approximate locations shown on the installation drawing, and slide the shipment skid out from under the machine. Do not attempt to lift the machine at only one point or at points other than recommended; failure to follow these instructions invites frame damage and will void the warranty.

NOTE: The lifting device must extend under the machine and support both sides of the frame structure. See drawing 803-091306 Furnace Arrangement for location.

2.2.5 Removal of Shipping Restraint Brackets

Large furnaces operating at high temperatures experience considerable growth from thermal expansion. All models are equipped with support slides which allow stress free expansion to take place. To secure the process chamber during shipment, restraining brackets (labeled SHIPPING BRACKET) attach directly between the chamber and frame.

Before operating the furnace first remove the top hex nuts and washers which secure each bracket to the frame. Then remove the shipping bracket and discard or store for use when moving the furnace again.

WARNING: Failure to remove the top bracket invites structural damage and will void the warranty.

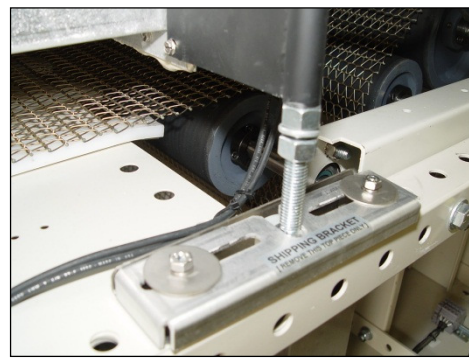

Figure 2-2 Shipping Brackets

2.2.6 Leveling Machine

Remove the base covers and using an open-end wrench on the screw flats, adjust the leveling feet to level (Figure 2-3) the frame within 0.06 inch overall. Tighten leveling nuts to lock in place.

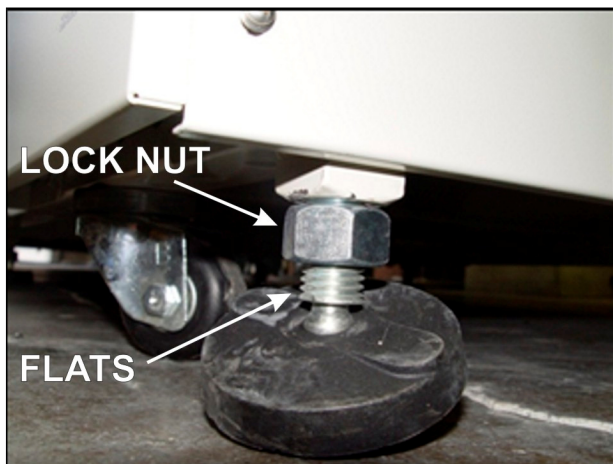

Figure 2-3 Leveling Feet

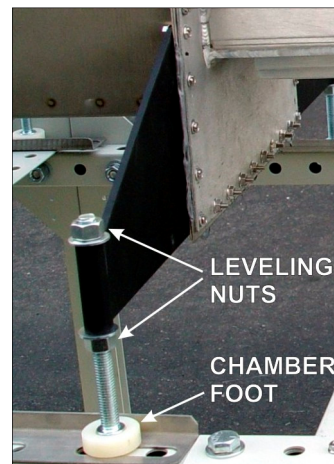

Figure 2-4 Chamber Support Bracket

After the frame is level, adjust the 2 Leveling Nuts (Figure 2-4) on each of the 8 Chamber Support Brackets to 0.06 inch overall. See location of brackets in Figure 2-5. Adjust so that all brackets evenly support the weight of the furnace chamber assembly. Tighten nuts to lock in place.

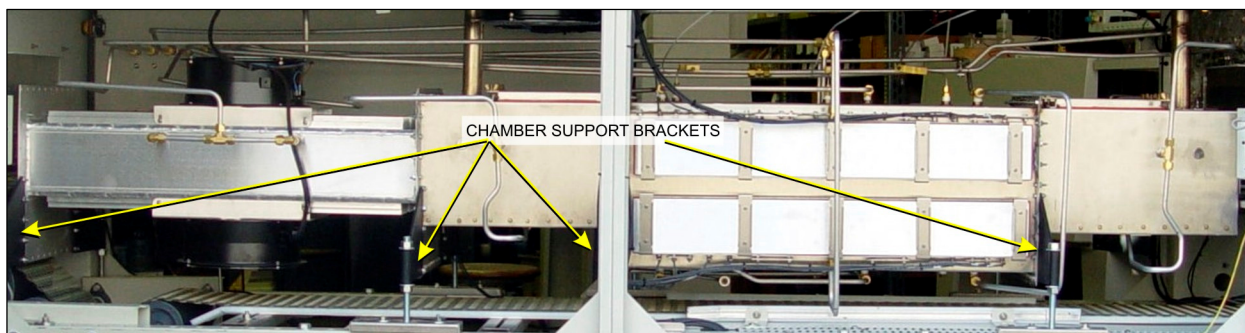

Figure 2-5 Location of Support Brackets

2.2.7 Installation of the Transport Belt

LA-306 furnaces are usually shipped with the belt already properly installed. However, if the shipment is expected to be exposed to rough handling or irregular terrain during shipment, the transport belt may have been intentionally left uninstalled to protect the furnace interior. This section can be used for installing the belt on a new furnace or for replacing a damaged or worn belt.

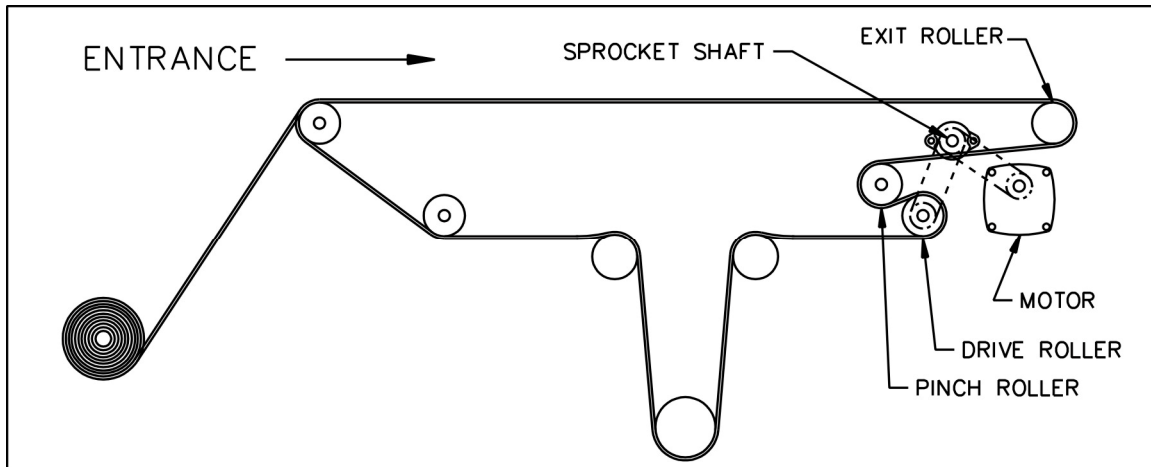

Figure 2-6 Belt Path

When installing the belt, have an assistant ready to help guide the belt into the furnace entrance.

A. Threading Belt

Extend a long wire or stick (to act as a pull rod) through the furnace chamber, being careful not to damage the lamps or insulation.

Securely attach the leading edge of the belt to the pull rod. Carefully pull the belt through the furnace from the exit end, while an assistant at the entrance unrolls and guides the belt into the furnace.

When the belt has been pulled through the furnace chamber, remove the pull rod and thread a pull wire through the rollers and drive drum, as shown in Figure 2-6. Pull the leading edge of the belt to the entrance and splice.

B. Splicing the Belt

Line up the ends of the belt so they are parallel and slightly overlapping.

Splice the belt by inserting one of the cross-section wires through the belt mesh across the width of the belt as shown in Figure 2-8.

The wire should be even and parallel and aligned with the belt edges. The cross-section wire will stay in place without any finishing at either end.

C. Belt Weight

Install belt weight as shown in Section 2.2.8B, Figure 2-11 and Figure 2-12.

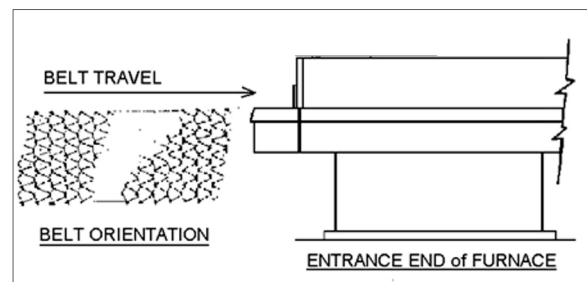

Figure 2-7 Belt Orientation

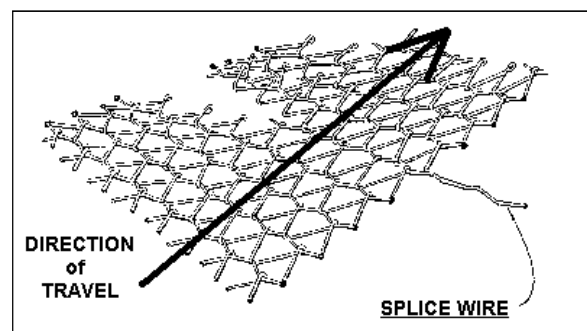

Figure 2-8 Belt Splice

2.2.8 Unpacking and Installation of Belt Weight

A. Locate and Unpack Belt Weight

Remove one of lower side panel near the furnace exit (below Control Enclosure). Using a flat screw driver turn the two latches to release and pull off the panel. This panel can be rotated and hung from the upper panel.

Locate the belt weight as shown in Figure 2-10. Unwrap and remove packing.



Figure 2-9 Lower Access Panel

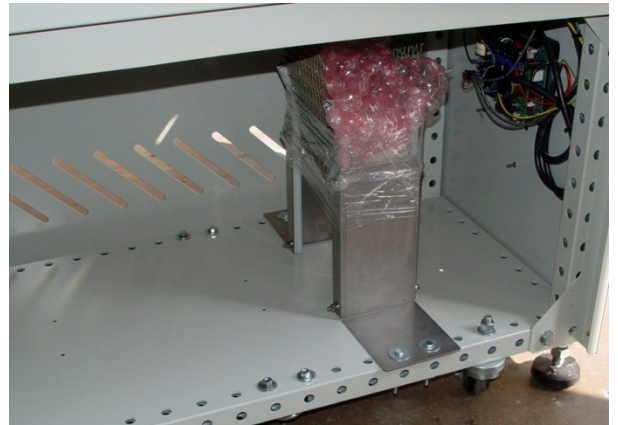

Figure 2-10 Belt Weight with packing

B. Install Belt Weight

Reinsert belt weight as shown in Figure 2-11. If necessary, pull belt to the left or right to align Belt so that Belt Weight is allowed to move freely as shown in Figure 2-12.



Figure 2-11 Belt Weight in Place

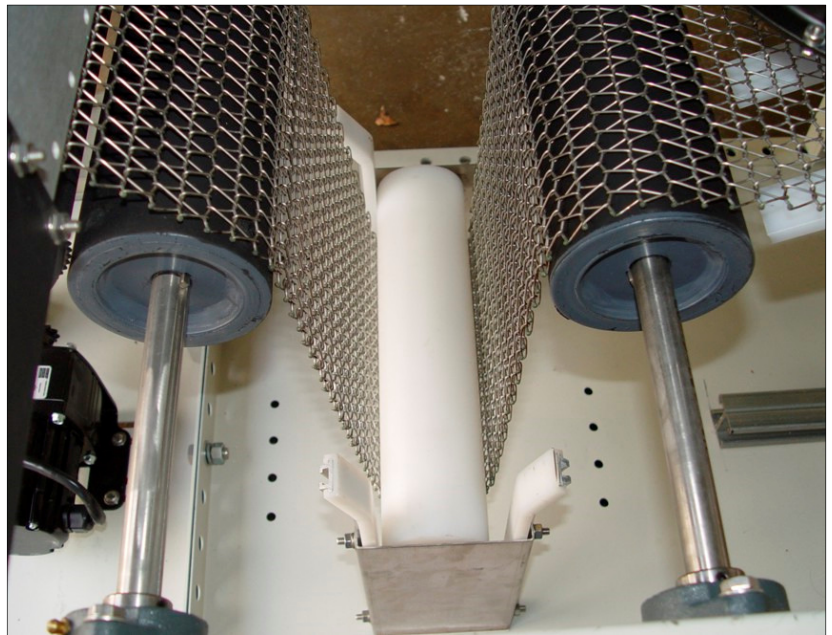

Figure 2-12 Proper Alignment of Belt Weight

2.3 Providing Power

The furnaces are shipped wired for the voltage specified on the nameplate. For all cases (except when a separate 3-phase circuit breaker is installed) electrical power, matching the specifications on the nameplate shall be connected to terminal block TB1 via the access panel on the Control Enclosure.

Unscrew top fastener using a Philips head screwdriver to open access panel. Connect power to terminal block through Power Input port on back the Control Enclosure.

Verify nameplate voltage and whether the furnace is configured for single phase or 3-phase power.

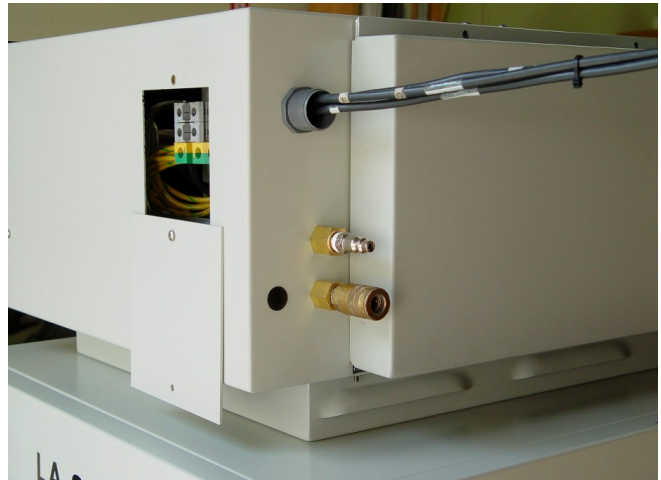

Figure 2-13 Standard Back Entry Power Port

WARNING: Do not connect power source different than as indicated on the label.

2.3.1 Facility Connections

Single phase 208-240 Vac power source connection

Connect as follows (refer to drawing 802-101779-01):

1. Connect facility power LINE to TB1-01 terminal
2. Connect the NEUTRAL to TB1-02 terminal
3. Connect the Earth ground to the TB1-GND (yellow/green) terminal.



Figure 2-14 1-PH

3-phase 208-240 Vac power source connection

Connect only as a 3-phase with no connection to Neutral (3-phase inside Delta connection) - (refer to drawing 802-101779-01):

1. Connect facility Leg 1 to TB1-01 terminal
2. Connect facility Leg 2 to TB1-02 terminal
3. Connect facility Leg 3 to TB1-03 terminal
4. Connect the Earth ground to the TB1-GND (yellow/green) terminal.



Figure 2-15 208-240Vac, 3-PH, 4 wire

3-phase 380-415 Vac power connection

Connect only as a 3-phase with a Neutral (3-phase “Y” connection) refer to drawing 802-101779-02:

1. Connect facility Leg 1 to TB1-01 terminal
2. Connect facility Leg 2 to TB1-02 terminal
3. Connect facility Leg 3 to TB1-03 terminal
4. Connect the facility NEUTRAL to TB1-04 terminal
5. Ground:
 - a) If a 4-wire system, keep jumper between TB1-04 and Ground.
 - b) If a 5-wire system, remove jumper and connect the Earth ground to the TB1-GND (yellow/green) terminal.



Figure 2-16 380-415Vac, 3PH 4-wire

2.3.2 Single Phase Circuit Breaker (CB-1)

On single phase furnaces, a single-phase circuit breaker supplied as standard, will be mounted in the Control Enclosure on top of the furnace at the location shown on the Furnace Arrangement drawing. See example in Figure 2-17. Wire supply power to the terminal block TB1 as instructed in section 2.3. All national, city and local codes should be followed when wiring this system for power.

See Facilities drawing 803-091306 and Chapter 10 Engineering, and Chapter 11 Specifications for power requirements with connected and operating loads.



Figure 2-17 Single Phase Circuit Breaker

2.3.3 Three Phase Circuit Breaker (CB-3 option □)

A three-phase circuit breaker, if supplied, will be mounted in a separate enclosure on top of the furnace at the location shown on the Furnace Arrangement drawing. Wire supply power to the terminal block TB1 as instructed in section 2.3. All city and local codes should be followed when wiring this system for power.

See Facilities drawing 803-091306 and Chapter 10 Drawings, and Chapter 11 Specifications for power requirements with connected and operating loads.



Figure 2-18 3-Phase Circuit Breaker (Option)

2.4 Providing Process Gas

Oil-free dry process gas at a maximum recommended dew point of 15°C (59°F), shall be brought to the machine through a customer supplied lines with a minimum inside diameter of 3/4 inch. Initial supply pressure shall not exceed 70 psig (except if optional supply gas Mixing System is included. In addition to a supply line filters and condensate traps, and regulators to reduce supply pressure to 70 psig must be installed on the supply line before entering the furnace.

DANGER: The flowmeters on these furnaces are rated at 70 psi maximum. Operating above 70 psi exposes the operator to possible injury.

The supply temperature of any gas including air should be above the dew point of the room air to prevent condensation from forming on the feed lines and dripping into the furnace.

See 803-091306 Furnace Arrangement drawing for locations of process connections. An example of typical process air connection is shown in Figure 2-19.

2.4.1 Single Gas Furnace

On single gas furnaces, Gas 1 port is for connecting CDA (clean dry compressed air) or nitrogen or other process gas to supply all furnace flowmeters on the front of the control console. Gas 1 port is a 1/4 inch female pipe connection.

2.4.2 Dual Gas Furnace (DGO option □)

On Dual Gas furnaces (optional), Gas 1 is the primary gas connection for CDA or nitrogen to all furnace auxiliaries including inlet and transition tunnel baffles, entrance exhaust stack eductor, lamp seals and CACT cooling chamber. Gas 1 port is a 1/4 inch female pipe connection.

Gas 2 port is for nitrogen or forming gas supply to the furnace heating chambers. Gas 2 port is a 1/4 female pipe connection.

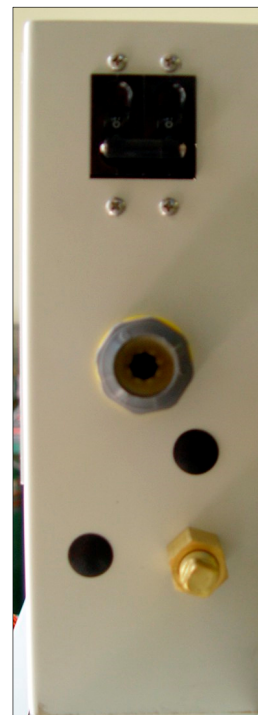

Figure 2-19 Process Gas Connections – Single Gas



Figure 2-20 Process Gas Connections - Dual Gas



DANGER: Except for furnaces specifically equipped with the hydrogen option, combustible gas should NOT be connect to the furnace. Forming gas or other gas mixtures which have a combustible gas component can be safely introduced into furnace provided the delivered concentration is below its lower flammable limit (LFL) in air.

2.4.3 Supply Gas Mixing System (GSM option □)

An option on Dual Gas furnaces, the Supply Gas Mixing System facilitates connection of two process gases which can then be alternatively selected or mixed while the furnace is operating. In addition, the system includes two pressure regulators that can accept supply line pressures of from 100 psi – 3500 psi (6.5-240 bar). Pressure gauges in both lines allow the user to adjust the pressure on both lines to the pressure the furnace require: 70 psig (4.8 bar).

Gas 1 is the primary gas connection for nitrogen to all furnace auxiliaries including inlet and transition tunnel baffles, entrance exhaust stack eductor, lamp seals and CACT cooling chamber. In addition, this port feeds the N₂ (Nitrogen) supply pressure gauge and flowmeter located on the side of the control console. Gas 1 port is a ¼ inch female pipe connection.

Gas 2 port is for premixed FG (forming gas) supply. This port feeds the FG (N₂/H₂) premix supply pressure gauge and flowmeter on the side of the control console. Gas 2 port is a ¼ inch female pipe connection.

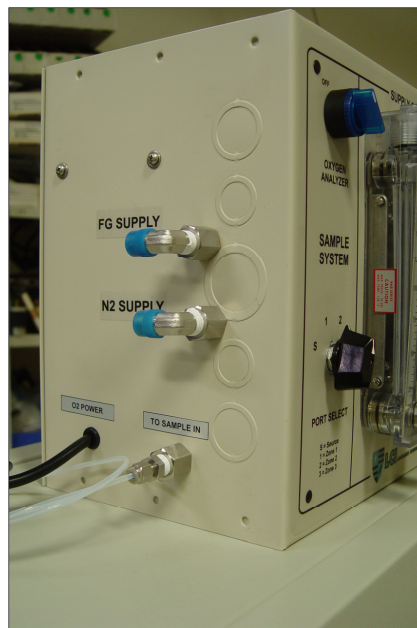

Figure 2-21 Process Gas Connections with Supply Gas Mixing System & Sample System

2.5 Analyzers and Sampling

2.5.1 Sampling System (OSS option □)

The sampling system option may require connection of an analyzer to the sample port if not already connected internally on the furnace. Figure 2-21 depicts an analyzer connected via Teflon tubing to the sampling system enclosure.

2.5.2 Oxygen Analyzer (OA option □)

An option available on most furnaces, an Oxygen Analyzer can be positioned on the top of the furnace and connect to a sample port or integrated with an OSS Sampling System.

A. Installation

Gently remove the oxygen analyzer from the box and place on the LA-306 furnace near the sample line port located on the side of the Control Enclosure or, if a separate Sample System Enclosure is provided as shown in Figure 2-22.

Connect power cable to power plug on back of analyzer, see Figure 2-23.

Connect sample gas line to oxygen analyzer SAMPLE IN connection. Hand tighten fitting.

If so configured, connect the SAMPLE OUT line the vent line. To isolate the cell when not in use, if not already installed, you may connect a check valve to the SAMPLE OUT vent line. However, make sure that the check valve does not pressurize the cell. The check valve should require less than 23 mbar (1/3 psig) to open.

Turn ON power switch located just above power cord on back of analyzer (Figure 2-23).

Open IN valve (top valve) full CCW (Figure 2-23).

With analyzer on, open OUT valve sufficiently to obtain 0.1-0.15 L/min on the flowmeter.

B. Analyzer Relocation

The analyzer can be removed and used on other devices. To remove the analyzer:

1. Close sample gas valves.
2. Unplug power to analyzer.
3. Remove sample line at analyzer.
4. Gently relocate analyzer.
5. Install as in 2.5.2A, except:
 - a) Use power cable with finished with plug and socket to connect to 117 Vac at an alternate location.
 - b) Use alternate Teflon line with fittings to connect to alternate sample source.

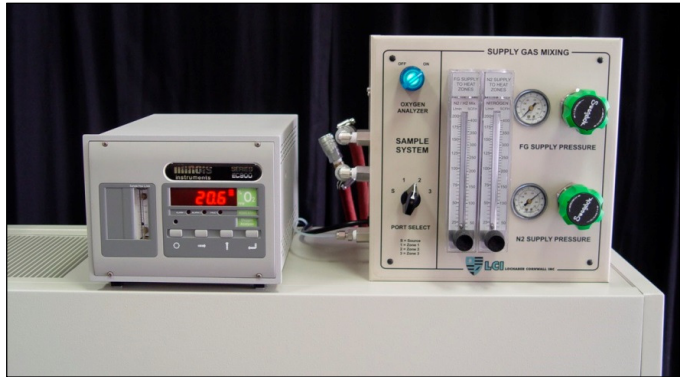

Figure 2-22 Oxygen analyzer on furnace

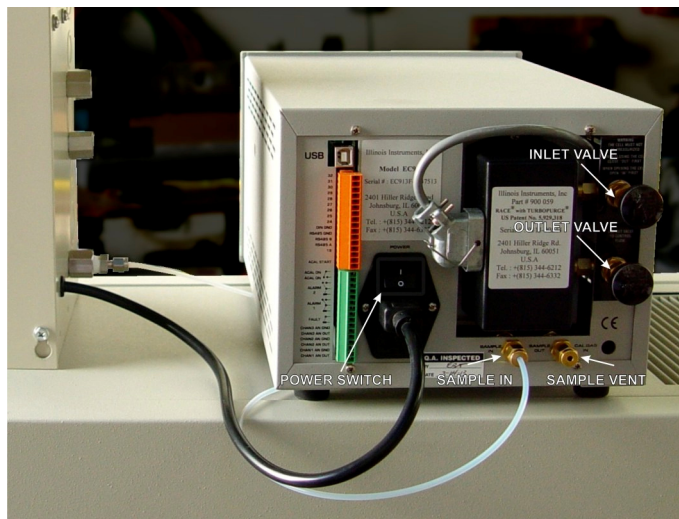

Figure 2-23 Analyzer power & sample line connection

2.6 Product Alert Sensors

2.6.1 Laser Product Alert (SENSLAS option □)

Furnaces equipped with a SENSLAS laser product sensor may require installation of the sensor if shipped separately. To install the SENSLAS sensor:

1. Insert bracket threaded legs through holes on Unload Station and fasten each leg with a washer and hex nut below the Unload Station table (see Figure 2-24).



Figure 2-24 Install SENSLAS bracket

2. Level bracket by loosening and tightening nuts above and below Unload Station table (see Figure 2-25).

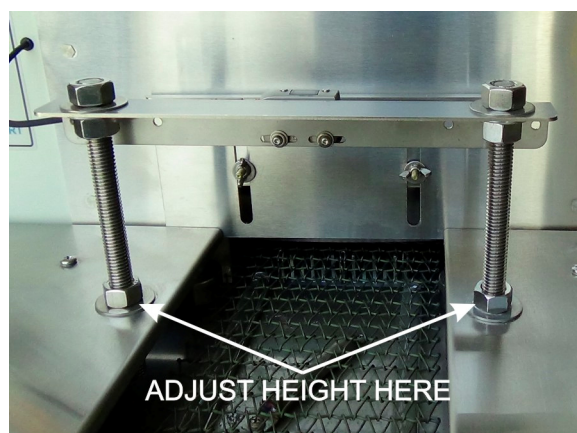

Figure 2-25 Adjust SENSLAS bracket height

3. If sensor is not already attached to bracket, install sensor to bracket using supplied fasteners. Adjust to center laser over product lane and tighten. See single lane example in Figure 2-26.

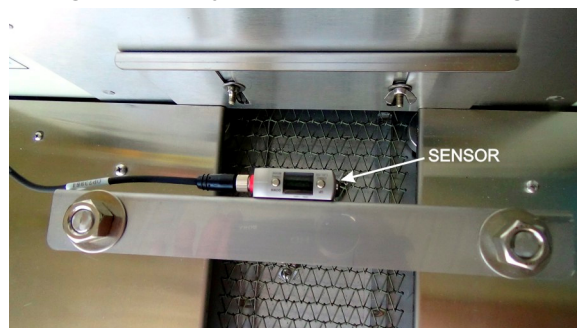

Figure 2-26 Install SENSLAS sensor over center of product lane

4. Connect sensor cable to sensor and hand tighten. See Figure 2-27.

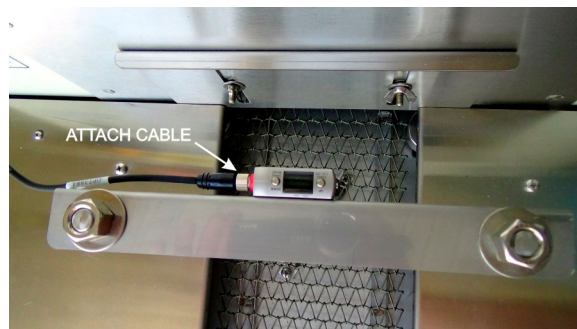

Figure 2-27 Connect SENSLAS cable

2.7 Exhaust Requirements

2.7.1 Cabinet Gas Exhaust Requirements

A 4-inch round duct with 8x12 inch rectangular hood can be installed above the 10-inch diameter cabinet cooling exhaust fan to reduce the additional heat load the furnace can add to its environment. This duct generally does not need to be insulated. Since the cabinet fan only cools the cabinet interior, if the furnace is installed in an adequately ventilated room, this exhaust duct may not be required.

See 803-091306 Facility Arrangement for suggested duct and hood locations.

2.7.2 Non-combustible Process Gas Exhaust Requirements

In most applications, process exhaust and heat is vented to the outside atmosphere. It is the customer's responsibility to review the process, local laws, and facility in deciding on an exhaust system. Insulated exhaust duct and a collector hood are routinely used for non-combustible process gas. **Do not** make any direct connections to the furnace exhaust stacks or apply any load to the furnace itself. A minimum 2.0 inch clearance between the 3-inch diameter exhaust stacks and venting hood or device is required. We recommend a 4-inch diameter insulated exhaust duct with an 8-inch diameter insulated hood.

Figure 2-28 Exhaust Connection and Figure 2-29 Exhaust Connection Detail show typical exhaust connections.

See 803-091306 Facility Arrangement for suggested duct and hood locations.



Figure 2-28 Exhaust Connection



Figure 2-29 Exhaust Connection Detail

2.7.3 Collector Hood Exhaust Requirements

An optional collector hood may be installed at the furnace entrance and/or exit to remove process gas from the furnace chambers. Connect insulated exhaust duct for non-combustible process gas to each 4-inch diameter duct ring provided on each collector hood. However, do not make any connections that will apply any load to the furnace itself. We recommend a 4-inch diameter insulated exhaust duct. Often a damper is installed in the facility exhaust duct to allow operators to limit the impact of the exhaust system on furnace performance

If included, see Furnace Arrangement drawing for collector hood location.

2.7.4 Combustible Process Gas Exhaust Requirements (hydrogen option only □)

In most applications, process exhaust and heat must be vented to the outside atmosphere. It is the user's responsibility to review the process, local laws, and facility in deciding on an exhaust system. If combustible gases are present, a wide collector hood suitable for 300°C operation with a 30-inch inside diameter, or larger, is routinely used. The hoods are typically located a minimum of 24 inches above each igniter stack. See Furnace Arrangement drawing for suggested sizes and locations.

Do not make any direct connections to any chamber exhaust stack or apply any load to the furnace itself. Clearance between the exhaust stacks and venting device is required. See Figure 2-30 for example of a typical hydrogen furnace exhaust connection.



Figure 2-30 Typical Hydrogen Furnace Process Gas Exhaust Connection

2.8 Water and Drain Connections

2.8.1 Water Supply and Drain Connections for UCD (option □)

Furnaces equipped with an ultrasonic cleaner dryer (UCD) system will require the customer to connect clean water supply lines to the connections provided.

Pipe water supply connection through rectangular opening in lower panel similar as shown Figure 2-31. Supply pressure shall not exceed 100 psig. The furnace shall include a water pressure regulator to reduce water pressure to a maximum of 30 psig.

Drains. For UCD systems a drain line capable of intermittent flows of 40 gpm at 40 psi (5-10 minute durations) must be connected to the water drain connection. . See Furnace Arrangement drawing 803-091306 for connection locations, sizes and maximum and typical flow rates.



Figure 2-31 UCD Water Connections with Air Purge

2.8.2 Process Gas Reservoir (option □)

If a CDA reservoir tank is supplied, it may be desirable to connect a drain line to the purge valve to accommodate low pressure discharges of water. See Figure 2-31 for air purge connection example.

Recommended initial setup and checkout of the LA-306 IR furnace. Perform after the furnace has been moved to a new location or if the furnace has been inactive for longer than 90 days.

3.1 Emergency Machine Off Switch (EMO)

Pressing an EMO button, located at each end of the furnace, cuts all power to the machine circuits immediately. Rotating the button CW and pulling outward will reset the button. Both buttons must be reset to connect power to the furnace.

Note: These buttons are for emergency use only and should not be used for routine shutdown of the furnace.

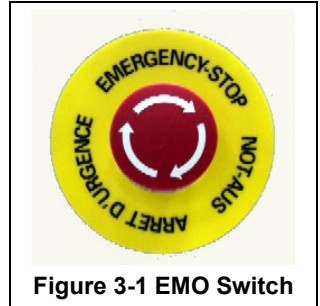

Figure 3-1 EMO Switch

3.2 Interlocks

There are three (3) electrical interlocks on the furnace: One on the Control Enclosure Access Door, and one on each of the Lower Entrance Panels, Front and Rear, opposite the heating chamber. During normal operation, all three of these access panels must be in place to allow power to be applied to the furnace. Opening the Control Enclosure Access Door or removing either Lower Entrance Panel causes an interlock to cut all power to the furnace.

The Control Enclosure Top Access Panel is held in place by machine screws and is NOT interlocked. This panel should always be in place while power is being applied to the furnace.

The interlocks are for your protection since both 117 Vac and 208-415 Vac circuitry and connections are inside the control enclosure and heating chamber. Trained personnel with a good understanding of the dangers involved may choose to override the interlocks by pulling outward on the interlock shaft to the “maintenance” position to restore power to the furnace while the interlocked panels are still removed.

DANGER: Dangerous voltage and current (potentially lethal) may be present in the control box with the interlocks in “maintenance” position.



Figure 3-2 Lower Panel Interlock

3.3 Control Console

During normal operation the user will manage all furnace functions via the Control Console. Figure 3-3 shows an operating Control Console. The elements of the Control Console are described in Section 1.14.

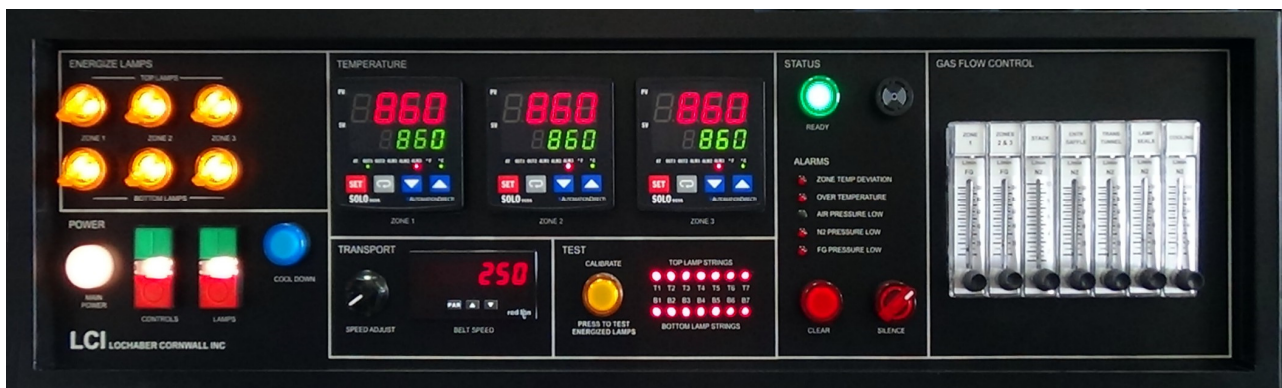

Figure 3-3 LA-306 Control Console ON

3.4 Functional Checkout

Before operating the furnace the first time, after moving the furnace to a new location or after a prolonged shutdown (more than 90 days), a functional check of critical machine functions is essential for successful operation.

Table 3-1 Functional Checkout																	
Action	Comments / Changes																
1. Replace covers	Install any covers that are off the machine or that were removed during checkout.																
2. Confirm MAIN POWER light ON	If not on, turn on power to the furnace. Caution: Dangerous voltages and current are now present throughout the control enclosure and on lamp wire connections to the furnace lamps.																
3. Turn on the process gas supply valve	Adjust gas pressure on inlet regulator to between: 4.5 – 5 bar 450 – 500 kPa 65 – 70 psig Note: Exceeding the upper limit could damage the flowmeters. Note: If there is a pressure regulator at the furnace (recommended) them assure at least 90 psig is supplied to the furnace regulator.																
4. Adjust process gas flowmeters	Adjust gas flowmeters on GAS FLOW CONTROL panel for the functional checkout per the table below. Use same settings for CDA, N ₂ or FG. Final gas flow settings during operation must be adjusted to suit the process and product being fired. The figures below are only a starting point for initial setup.																
4a. Recommended Initial settings for normal processing. Adjust as necessary to improve performance and stability. NOTE: The furnace internals must be dry and the furnace must be located in a dry environment. Protect entrance and exit from drafts. Operate for 60 minutes once stable to improve repeatability. Initial, continuous operation with nitrogen at process temperatures may be required for 4 hours or longer to remove residual moisture from furnace internals and all process gas feed lines.	For single or dual gas manifold , Z1-Z3 @ 500C, CDA or N ₂ balanced flow: <table border="1"> <thead> <tr> <th>Flowmeter</th> <th>Setting (L/m)</th> </tr> </thead> <tbody> <tr> <td>STACK</td> <td>4.1</td> </tr> <tr> <td>ENTR BAFFLE</td> <td>5.0</td> </tr> <tr> <td>ZONE 1</td> <td>30.0</td> </tr> <tr> <td>ZONES 2 & 3</td> <td>30.0</td> </tr> <tr> <td>TRANS TUNNEL</td> <td>7.0</td> </tr> <tr> <td>LAMP SEALS*</td> <td>16.0</td> </tr> <tr> <td>COOLING**</td> <td>16.0</td> </tr> </tbody> </table> (all settings ± 10%)	Flowmeter	Setting (L/m)	STACK	4.1	ENTR BAFFLE	5.0	ZONE 1	30.0	ZONES 2 & 3	30.0	TRANS TUNNEL	7.0	LAMP SEALS*	16.0	COOLING**	16.0
Flowmeter	Setting (L/m)																
STACK	4.1																
ENTR BAFFLE	5.0																
ZONE 1	30.0																
ZONES 2 & 3	30.0																
TRANS TUNNEL	7.0																
LAMP SEALS*	16.0																
COOLING**	16.0																
*Set LAMP SEALS for minimum 12 L/m up to 400°C plus 2.5 L/m per 100°C above 400°C to prolong lamp life.																	
**Set COOLING for minimum 8 L/m up to 200°C (in Zone 3) plus 2.5 L/m per 100°C above 200°C to protect CACT.																	

Table 3-1 Functional Checkout																	
Action	Comments / Changes																
<p>4b. Flowmeter settings for processing with low oxygen</p> <p>NOTE: The furnace internals must be dry and the furnace must be located in a dry environment. Protect entrance and exit from drafts to keep furnace internal oxygen concentration low. Initial continuous operation with nitrogen at process temperatures may be required for 4 hours or longer to remove residual moisture from the inside of the furnace and all process gas feed lines.</p>	<p>For single or dual gas manifold Z1-3@500C, Very Low O2 Firing, slightly positive atmosphere furnace:</p> <table border="1"> <thead> <tr> <th>Flowmeter</th> <th>Setting (L/m)</th> </tr> </thead> <tbody> <tr> <td>STACK</td> <td>1.0</td> </tr> <tr> <td>ENTR BAFFLE</td> <td>7.0</td> </tr> <tr> <td>ZONE 1</td> <td>45.0</td> </tr> <tr> <td>ZONES 2 & 3</td> <td>45.0</td> </tr> <tr> <td>TRANS TUNNEL</td> <td>6.0</td> </tr> <tr> <td>LAMP SEALS*</td> <td>16.0</td> </tr> <tr> <td>COOLING**</td> <td>16.0</td> </tr> </tbody> </table> <p>(all settings \pm 10%)</p>	Flowmeter	Setting (L/m)	STACK	1.0	ENTR BAFFLE	7.0	ZONE 1	45.0	ZONES 2 & 3	45.0	TRANS TUNNEL	6.0	LAMP SEALS*	16.0	COOLING**	16.0
Flowmeter	Setting (L/m)																
STACK	1.0																
ENTR BAFFLE	7.0																
ZONE 1	45.0																
ZONES 2 & 3	45.0																
TRANS TUNNEL	6.0																
LAMP SEALS*	16.0																
COOLING**	16.0																
	<p>*Set LAMP SEALS for minimum 12 L/m up to 400°C plus 2.5 L/m per 100°C above 400°C to prolong lamp life.</p> <p>**Set COOLING for minimum 8 L/m up to 200°C (in Zone 3) plus 2.5 L/m per 100°C above 200°C to protect CACT.</p>																
<p>5. Push CONTROLS green button</p>	<p>Powers up the control system.</p> <p>Wait a few seconds for the zone controllers to initialize and display current zone and setpoint temperatures (Main Screen).</p> <p>Check that the cabinet cooling exhaust fans, and optional cooling tunnel exterior fans and product cooling fans are turning</p> <p>If a zone controller displays no Cont, Err LnPE, or Err Pron see Section 4.2.1. of Furnace Alerts and Alarms for possible causes and remedies.</p>																
<p>6. Check transport belt operation.</p>	<p>Vary the conveyor speed from minimum (25 mm/m or 1 ipm) to maximum (508 mm/m or 20 ipm) using the TRANSPORT panel BELT SPEED knob.</p> <p>Check for smooth belt operation at all speeds.</p> <p>As a quick check on the belt speed, set the belt speed to 508 mm/m, 50 cm/min or 20 ipm. Place an object on the moving belt and time it from when it enters the furnace until it exits the furnace. The distance from furnace chamber entrance to chamber exit is 2336 mm (92 in). Divide this distance by the time in minutes (for example: a time of 4 minutes and 36 seconds converts to 4.6 minutes) to get an estimate of the actual belt speed. This estimate will vary with the accuracy of your timing measurement, but assuming a 3-second error over 4.6 minutes, your estimate should be within 1% of the speed shown on the BELT SPEED readout.</p>																

Table 3-1 Functional Checkout





Action	Comments / Changes
7. Set all zone controllers to 300 °C	<p>Press controller  or  keys to enter the setpoint temperature on the green SV display, and  key to store the value.</p> <p>Notice how the dim setpoint temperature SV display will brighten when the  key stores the value.</p>
8. Check zone switches	<p>On the ENERGIZE LAMPS panel, cycle each zone switch, one at a time, and verify that the zone indicator lamp turns ON (turn CW) and turns OFF (turn CCW).</p> <p>Finally, for the next step in this functional checkout, set <u>all</u> zone switches OFF (CCW).</p>

Table 3-1 Functional Checkout																													
Action	Comments / Changes																												
<p>9. Check zone power and lamps: On the TEST panel, press the CALIBRATE pushbutton (ON).</p> <p>Note: If the Temperature Deviation alert sounds during this test it can be silenced by turning the SILENCE switch CW on the STATUS panel.</p> <p>Note: A 2-minute timer may shut off the CALIBRATE signal (the pushbutton lamp will go OFF if this happens) before you complete this check of zone power and lamps. If this happens, press the CALIBRATE pushbutton again to continue to send the calibration signal to the SCRs.</p> <p>Note: Try to perform this lamp check quickly as the zone temperatures rise while the calibration signal is applied to the lamps.</p>	<p>One at a time, turn the zone switches ON (CW) and push the LAMPS green button to turn on power to the lamps. Verify that these LAMP STRINGS indicators on the TEST Panel turn ON when the corresponding zone switch is ON:</p> <p>For standard power LA-306 furnaces,</p> <table border="1"> <thead> <tr> <th><u>Zone Switch</u></th> <th><u>LAMP STRINGS</u></th> </tr> </thead> <tbody> <tr> <td>ZONE 1 TOP</td> <td>T1, T2</td> </tr> <tr> <td>ZONE 2 TOP</td> <td>T3, T4</td> </tr> <tr> <td>ZONE 3 TOP</td> <td>T5, T6</td> </tr> <tr> <td>ZONE 1 BOTTOM</td> <td>B1, B2</td> </tr> <tr> <td>ZONE 2 BOTTOM</td> <td>B3, B4</td> </tr> <tr> <td>ZONE 3 BOTTOM</td> <td>B5, B6</td> </tr> </tbody> </table> <p>For high power LA-306 furnaces,</p> <table border="1"> <thead> <tr> <th><u>Zone Switch</u></th> <th><u>LAMP STRINGS</u></th> </tr> </thead> <tbody> <tr> <td>ZONE 1 TOP</td> <td>T1, T2</td> </tr> <tr> <td>ZONE 2 TOP</td> <td>T3, T4, T5</td> </tr> <tr> <td>ZONE 3 TOP</td> <td>T6, T7</td> </tr> <tr> <td>ZONE 1 BOTTOM</td> <td>B1, B2</td> </tr> <tr> <td>ZONE 2 BOTTOM</td> <td>B3, B4, B5</td> </tr> <tr> <td>ZONE 3 BOTTOM</td> <td>B6, B7</td> </tr> </tbody> </table> <p>If all 2 or 3 lamp strings are ON, that bank of lamps is good.</p> <p>Push the LAMPS red button to shut OFF the lamps. Turn the zone switch OFF (CCW). Repeat this process until all zone switches and lamp strings have been checked.</p> <p>At the end of this check, the LAMPS should be OFF.</p> <hr/> <p>If one of the lamp strings LEDs is OFF, the string may have a burned out lamp that needs to be replaced. See section 4.5.</p> <p>If all lamp strings LEDs are OFF for any pair of zone switches for the same zone (for instance T1 and T2, B1 and B2), it means that the zone has a blown fuse (most likely) or an SCR controller (least likely) that needs to be replaced. See sections 7.5.4 and 7.5.5.</p>	<u>Zone Switch</u>	<u>LAMP STRINGS</u>	ZONE 1 TOP	T1, T2	ZONE 2 TOP	T3, T4	ZONE 3 TOP	T5, T6	ZONE 1 BOTTOM	B1, B2	ZONE 2 BOTTOM	B3, B4	ZONE 3 BOTTOM	B5, B6	<u>Zone Switch</u>	<u>LAMP STRINGS</u>	ZONE 1 TOP	T1, T2	ZONE 2 TOP	T3, T4, T5	ZONE 3 TOP	T6, T7	ZONE 1 BOTTOM	B1, B2	ZONE 2 BOTTOM	B3, B4, B5	ZONE 3 BOTTOM	B6, B7
<u>Zone Switch</u>	<u>LAMP STRINGS</u>																												
ZONE 1 TOP	T1, T2																												
ZONE 2 TOP	T3, T4																												
ZONE 3 TOP	T5, T6																												
ZONE 1 BOTTOM	B1, B2																												
ZONE 2 BOTTOM	B3, B4																												
ZONE 3 BOTTOM	B5, B6																												
<u>Zone Switch</u>	<u>LAMP STRINGS</u>																												
ZONE 1 TOP	T1, T2																												
ZONE 2 TOP	T3, T4, T5																												
ZONE 3 TOP	T6, T7																												
ZONE 1 BOTTOM	B1, B2																												
ZONE 2 BOTTOM	B3, B4, B5																												
ZONE 3 BOTTOM	B6, B7																												
<p>10. Press the CLEAR button on the ALARM panel</p>	<p>Ends CALIBRATE MODE and returns control of the lamp SCRs to the zone controllers.</p>																												
<p>11. Wait for zone temperatures to settle, if necessary</p>	<p>Monitor zone controllers until all zone PV temperatures (red display) are at, or below, 300 °C (green display).</p>																												
<p>12. Set all zone switches ON.</p>																													

Table 3-1 Functional Checkout

Action	Comments / Changes
<p>13. Push LAMPS green button</p>	<p>Turns lamps ON again.</p> <p>The K1 lamp contactor will close with an audible click sending power to the zone switches. Each zone controller OUT1 LED indicator (red) will be on.</p> <p>Zone PV temperatures will start to rise as increasing heat is reported by the zone thermocouples.</p> <p>The “soft start” controls will increase power gradually for the first 20 seconds of the warm up to limit the in-rush current to the lamps.</p> <p>The zone controllers will now drive the SCRs to produce just the correct amount of lamp power to keep the PV display from the thermocouple as close as possible to the SV setpoint temperature in each zone.</p>
<p>14. Wait for the green READY light</p>	<p>The furnace is now stabilized at 300 °C.</p> <p>When the READY light appears during normal operation (this may take several minutes), the furnace is ready to process parts.</p>
<p>15. Start of Shut Down Test: Push COOL DOWN START button</p>	<p>COOL DOWN blue indicator turns ON. The red CLEAR pushbutton will light as well.</p> <p>Lamps turn OFF. The red PV zone temperatures will start to fall as the zones cool. All fans, the transport belt, and the zone controllers stay on. See section 1.4.2 for more information.</p> <p>To speed the COOL DOWN process, the user may increase belt speed and gas flow in the zones.</p>
<p>16. Push CONTROLS red button while still in COOL DOWN mode.</p>	<p>Turns console controls OFF.</p> <p>The COOL DOWN Mode will keep the fans, transport belt, and the zone controllers ON until COOL TIME expires.</p> <p>When all zone temperatures are <100°C, all fans, the belt and the PLC and zone controllers shut off automatically.</p>
<p>17. When all zones are below 100 °C ...</p>	<p>Shut off the process gas supply valve.</p> <p>The functional test is complete.</p>

Operating instructions and guidelines for normal startup, operation and shutdown of the furnace. Refer to chapter 6 to view operating instructions for optional equipment.

4.1 Furnace Operation



Daily operation of the furnace requires a routine start up procedure to assure long life of the furnace and to guard against premature failures. In particular, gas flow should be established before turning on the heating elements to protect temperature sensitive components from excessive heat. To prolong lamp life, do not operate at zone temperatures above 1000 °C.

4.1.1 Retained Control Settings:

When power is shut off to the furnace control system, these settings are retained:

- All zone controller parameters, values and settings.
- The belt speed setting.
- Energized lamp selections.
- Gas flow settings.
- The alert/alarm buzzer silenced status.

4.1.2 Start Up Procedure (Cold Start – controls OFF, lamps OFF)

Table 4-1 Cold Start Up	
Action	Comments / Changes
1. Confirm MAIN POWER light ON	If not on, turn on power to the furnace.
2. Turn on the process gas supply valve	Adjust gas flowmeters on GAS FLOW CONTROL panel for appropriate flow for the product being fired.
3. Push CONTROLS green button	Powers up the control system. Wait a few seconds for the zone controllers to initialize and display current zone and setpoint temperatures (Main Screen).
4. Confirm desired setpoint temperatures	Press controller  or  keys to enter the temperature, and  key to store the value.
5. Confirm lamps to be energized	Select on the ENERGIZE LAMPS panel.
6. Confirm desired belt speed.	Set using the TRANSPORT panel BELT SPEED knob. Briefly examine the transport system, making sure the belt is operating smoothly.
7. Push LAMPS green button	Turns lamps ON. When the lamps first turn on, the SCR “soft start” capability limits the in-rush of current to the cold lamps.
8. Wait for the green READY light	The furnace is now ready to process product.

4.1.3 Change to a New Profile With a Hot Furnace (controls ON, lamps ON)



Table 4-2 Changing the Profile	
Action	Comments / Changes
1. Push LAMPS red button	Turns lamps OFF. The red PV zone temperatures will start to fall as the zones cool. The furnace control system will stay on, as will the transport belt, cabinet and cooling fans.
2. Set any new setpoint temperatures	Press controller ▼ or ▲ keys to enter the temperature, and SET key to store the value.
3. Confirm lamps to be energized	Select on the ENERGIZE LAMPS panel.
4. Confirm desired belt speed	Set using the TRANSPORT panel BELT SPEED knob. Briefly examine the transport system, making sure the belt is operating smoothly.
5. Set/confirm gas flowmeters	Adjust gas flowmeters on GAS FLOW CONTROL panel for appropriate flow for the product being fired.
6. Wait for zone temperatures to settle	Monitor zone controllers until all zone PV temperatures (red display) are at, or below, new SV temperatures (green display).
7. Push LAMPS green button	Turns lamps ON. Zone PV temperatures will start to rise as increasing heat is reported by the zone thermocouples. The “soft start” controls will increase power gradually for the first 20 seconds of the warm up to limit the in-rush current to the lamps.
8. Wait for the green READY light	The furnace is now ready to process product.

4.1.4 Place Hot Furnace in Standby Mode (controls ON, lamps OFF):

Table 4-3 Standby	
Action	Comments / Changes
1. Push COOL DOWN START button.	COOL DOWN blue indicator turns ON. The red CLEAR pushbutton turns on. Lamps turn OFF. The red PV zone temperatures will start to fall as the zones cool. All fans, the transport belt, and the zone controllers stay on. You can press the CLEAR pushbutton at any time to cancel COOL DOWN mode.
2a. If furnace is to be restarted in 1 hour or less ...	Maintain operational gas flows during short shut down periods to assure rapid stabilization upon start up.
2b. If furnace is to be in Standby Mode for more than 1 hour ...	When all zone temperatures fall below 200 °C, shut off the process gas supply valve.

The furnace can be left in this mode indefinitely without harm.

4.1.5 Resume Operation From Standby Mode (controls ON, lamps OFF):

Table 4-4 Resume Operation from Standby	
Action	Comments / Changes
1. Turn on the process gas supply valve	Adjust gas flowmeters on GAS FLOW CONTROL panel for appropriate flow for the product being fired.
2. Confirm desired setpoint temperatures	Press controller  or  keys to enter the temperature, and  key to store the value.
3. Confirm lamps to be energized	Select on the ENERGIZE LAMPS panel.
4. Confirm desired belt speed.	Set using the TRANSPORT panel BELT SPEED knob. Briefly examine the transport system, making sure the belt is operating smoothly.
5. Push LAMPS green button	Turns lamps ON.
6. Wait for the green READY light	The furnace is now ready to process product.

4.1.6 Completely Shut Down a Hot Furnace (controls OFF, lamps OFF):

Table 4-5 Shut Down	
Action	Comments / Changes
1. Push COOL DOWN START button	COOL DOWN blue indicator turns ON. Lamps turn OFF. The red PV zone temperatures will start to fall as the zones cool.
2. Push CONTROLS red button	Turns controls OFF. The COOL DOWN Mode will keep the transport belt, cabinet and cooling fans ON until all zone temperatures are <100 °C. When that condition exists, all displays, the belt, the fans, zone controllers and the PLC shut off automatically.
<u>IMPORTANT NOTE:</u> To exit COOL DOWN at any time, push the CONTROLS green button to turn the controls ON and press the red CLEAR pushbutton to cancel COOL DOWN. You are now in STANDBY mode; see 4.1.5 to resume operation.	
3. When all zones are below 200 °C ...	Shut off the process gas supply valve.

4.2 Furnace Alerts & Alarms

4.2.1 With the CONTROLS button ON:



Table 4-6 Alerts & Alarms – Controls ON	
Problem	Comments/Remedies
A zone controller displays no Cont or Err InPt instead of the process and setpoint temperatures:	<p>The thermocouple or its connection to the controller may be bad.</p> <p>Check the input wiring and the thermocouple (replace if necessary).</p>
A zone controller displays Err Proa instead of the process and setpoint temperatures:	<p>There is an error within the controller.</p> <p>Cycle the power to the controller by pressing the CONTROLS red button to shut down the control system, waiting 10 seconds, then pressing the CONTROLS green button to restart the control system. This should clear the problem and the Main Screen should appear.</p>

4.2.2 With the LAMPS button ON:

The buzzer sounds and/or the CLEAR button are lit.

Turn SILENCE switch clockwise to silence the buzzer.

Check STATUS panel LED indicators for source of error.

Table 4-7 Alerts & Alarms – Lamps ON	
Problem	Comments / Remedies
ZONE TEMP DEVIATION LED is ON:	<p>This is an Alert and the furnace will continue operation.</p> <p>Check all zone controllers for an ALM1 LED (red) indicator ON. That zone has experienced a process temperature outside the setpoint temperature +/- the ALM1 limits set in the controller. The factory set ALM1 limits are +/- 10°C.</p> <p>Try to remedy the situation while the furnace continues to run. Remedies include:</p> <p>Do nothing. It may have been a transient anomaly.</p> <p>Check eductor gas flow. You may have to adjust the entrance exhaust eductor flow slightly up or down to pull more or less zone heat towards front of furnace.</p> <p>Check zone gas flows. You may have to increase zone gas flow to increase flow stability through the zone.</p> <p>Change the zone setpoint. A slightly higher or lower temperature might better accommodate temperature fluctuations in this particular profile. Adjust the zone controller setpoint using the  or  keys to enter the temperature, and press SET key to store the value.</p> <p>Autotune the zone PID settings. See 5. Modifying Control Strategies, below.</p> <p>Widen the AL1H and/or AL1L limits set for the zone. See 5. Modifying Control Strategies, below.</p>
AIR PRESSURE LOW or N2 PRESSURE LOW or FG PRESSURE LOW LED is ON:	<p>This is an Alert and the furnace will continue operation.</p> <p>The indicated gas manifold has seen a drop in gas pressure.</p> <p>Remedy the situation while the furnace continues to run by immediately turning on the identified gas supply (or supplies) to the furnace.</p> <p>Note: If the gas supply (or supplies) cannot be restored immediately, push the COOL DOWN button to avoid damage to furnace components and do not operate furnace with lamps on until the gas supply can be restored.</p>

When the alert condition is remedied, and the ALM1 LED turns OFF, reset the alarm system and buzzer:

Push the CLEAR button. The CLEAR lamp and the ZONE TEMP DEVIATION LED turn OFF.



Turn the lighted SILENCE switch counterclockwise. The SILENCE lamp turns OFF and the audible buzzer is enabled.

Verify the green READY lamp is ON and return to normal furnace operation.

4.2.3 If the IR lamps shut off, buzzer sounds, the CLEAR lamp turns ON:

Turn the SILENCE switch clockwise to silence the buzzer.

Check STATUS panel LED indicators for source of error.

Table 4-8 Over Temperature Alarm	
Problem	Comments/Remedies
OVER TEMPERATURE LED is ON:	<p>This is an Alarm and the furnace cannot continue with the LAMPS turned ON.</p> <p>Check all zone controllers for a PV temperature at or near 1005 °C. That zone has experienced a process temperature higher than the ALM2 limit set in the controller. The factory set ALM2 limit is 1005 °C.</p> <p>Remedy the situation while the furnace cools down. Remedies include:</p> <p>Check eductor gas flow. You may have to adjust the entrance exhaust eductor flow slightly up or down to pull more or less heat towards front of furnace.</p> <p>Check zone gas flow. You may have to increase zone gas flow to increase flow stability through the zone.</p> <p>Change the zone setpoint. A slightly higher temperature might better accommodate temperature fluctuations in this particular profile. Adjust the zone controller setpoint using the  or  keys to enter the temperature, and press SET key to store the value.</p> <p>Autotune the zone PID settings. See 5. Modifying Control Strategies, below.</p> <p>Check affected zone SCR for “output stuck open” failure (i.e. applying full power to lamps with no control input signal). If confirmed, replace zone SCR immediately. See 4.3.2 for more information.</p>

When the alarm condition is remedied, and the ALM2 LED on the affected zone turns OFF, reset the alarm system and buzzer:

Push the CLEAR button. The CLEAR lamp and the OVER TEMPERATURE LED turn OFF.

Turn the lighted SILENCE switch counterclockwise. The SILENCE lamp turns OFF and the audible buzzer is enabled.

Push LAMPS green button to turn the lamps ON.

Verify the green READY lamp is on and then return to normal furnace operation.

4.3 Energizing Lamps

The ability to turn banks of lamps off and on via the zone switches on the ENERGIZE LAMPS panel allows the user great flexibility in applying energy to each zone. Use just the top lamps in each zone for drying moisture or volatile organic compounds from the top surface of substrates or trays, or curing thermosetting compounds or coatings on wafers or polycarbonate materials. Use both top and bottom lamps in traditional furnace applications. Use just the bottom lamps to emphasize conduction heating of parts from the transport belt and from IR radiation on the bottom of metallic or ceramic parts carriers.

4.3.1 Selecting banks of lamps

The user has great flexibility in applying energy to each zone. Select 1) top lamps only; 3) bottom lamps only; 4) both top and bottom lamps; or 5) no lamps at all for each zone. Choose which lamps you want to energize *before* pressing on the Lamps ON button to ensure smooth power up to operating temperatures.

4.3.2 Troubleshooting & resolving zone control issues using Zone Switches

Zone switches are also useful for testing lamps (see section 4-9) and checking for blown lamp fuses (see Table 7-2 Troubleshooting Power).

If heat in any zone increases rapidly into a “runaway” condition even if the zone controller OUT1 LED indicator is dark (the controller output is OFF), the heat can be stopped by shutting off the affected zone top and bottom switches. In this event, the zone SCR most likely has failed with an *output stuck open fault* and needs to be replaced.

If the heat in any zone steadily stays above the SV (temperature setpoint value), but is not in a *runaway* condition, shut off the affected zone top and bottom switches and see if the heat decreases. If it does not, the furnace has a process gas flow problem or the SV in adjacent zones may need to be lowered.

4.4 Belt Speed Considerations

The LA-306 is designed to continuously move parts through the process zones of the furnace. To promote long life of the equipment and assure best processing results, make sure belt is adjusted to a speed within its specified range and appropriate for the processing temperatures in the furnace.

Extremely low belt speeds (for instance, <0.5 ipm) can create hot spots and warping of the belt at temperatures above 800°C for Nichrome-V belts, or above 425°C for 316 stainless steel belts.

High belt speeds require consideration of exit temperatures of the belt and processed parts.



DANGER: At high temperatures and high belt speeds, workers may be exposed to dangerously hot surfaces that may be a potential threat to human safety and cause serious injury.

Adjust belt speed so parts can be safely removed from the furnace. Provide protective barriers if the product temperature is too high to safely handle.

Warning: At temperatures above 600°C make sure that the belt speed selected does not result in the belt exiting the furnace at too high a temperature and causing damage to the drive system rollers.

Adjust belt speed so that the belt is at or below 150°C (300°F) by the time it reaches the end of the furnace. Increasing transition tunnel and CACT cooling gas flow can help lower the belt temperature to a safe temperature.

4.5 Testing Lamps

Whenever the lamps are on, the TOP LAMP STRINGS and BOTTOM LAMP STRINGS LED displays on the TEST panel indicate that power is being delivered to each string of lamps selected to be ON via the ENERGIZE LAMPS panel zone switches. However, especially at zone temperatures below 300 °C, sometimes the lamps require very little power to maintain the SV temperature. When current in the lamps falls below the threshold of detection, the LED display for that string will turn OFF, indicating a *potential* burned out lamp. The user can test for burned out lamps using the zone calibration signal in the following manner.

Table 4-9 Lamp String Test																													
Action	Comments / Changes																												
1. Confirm MAIN POWER light ON.	If not on, turn on power to the furnace.																												
2. Confirm process gas supply ON.																													
3. Press CONTROLS green button.	Powers up the control system.																												
4. Select banks of lamps to be tested	Using the zone switches on the ENERGIZE LAMPS panel, turn each switch clockwise to ON to select.																												
5. Press LAMPS green button.	Turns LAMPS ON.																												
<p>6. On the TEST panel, press the CALIBRATE pushbutton (ON).</p> <p><u>Note:</u> If the Temperature Deviation alert sounds during this test it can be silenced by turning the SILENCE switch CW on the STATUS panel.</p> <p><u>Note:</u> A 2-minute timer may shut off the CALIBRATE signal (the pushbutton lamp will go OFF if this happens) before you complete this check of zone power and lamps. If this happens, press the CALIBRATE pushbutton again to continue to send the calibration signal to the SCRs.</p> <p><u>Note:</u> Try to perform this lamp check quickly as the zone temperatures will rise during this process while the calibration signal is applied to the lamps.</p>	<p>For each zone switch turned ON, verify that these LAMP STRINGS indicators on the TEST Panel turn ON:</p> <p>For standard power LA-306 furnaces,</p> <table border="1"> <thead> <tr> <th><u>Zone Switch</u></th> <th><u>LAMP STRINGS</u></th> </tr> </thead> <tbody> <tr> <td>ZONE 1 TOP</td> <td>T1, T2</td> </tr> <tr> <td>ZONE 2 TOP</td> <td>T3, T4</td> </tr> <tr> <td>ZONE 3 TOP</td> <td>T5, T6</td> </tr> <tr> <td>ZONE 1 BOTTOM</td> <td>B1, B2</td> </tr> <tr> <td>ZONE 2 BOTTOM</td> <td>B3, B4</td> </tr> <tr> <td>ZONE 3 BOTTOM</td> <td>B5, B6</td> </tr> </tbody> </table> <p>For high power LA-306 furnaces,</p> <table border="1"> <thead> <tr> <th><u>Zone Switch</u></th> <th><u>LAMP STRINGS</u></th> </tr> </thead> <tbody> <tr> <td>ZONE 1 TOP</td> <td>T1, T2</td> </tr> <tr> <td>ZONE 2 TOP</td> <td>T3, T4, T5</td> </tr> <tr> <td>ZONE 3 TOP</td> <td>T6, T7</td> </tr> <tr> <td>ZONE 1 BOTTOM</td> <td>B1, B2</td> </tr> <tr> <td>ZONE 2 BOTTOM</td> <td>B3, B4, B5</td> </tr> <tr> <td>ZONE 3 BOTTOM</td> <td>B6, B7</td> </tr> </tbody> </table> <p>If all 2 or 3 lamp strings are ON, that bank of lamps is good.</p> <hr/> <p>If one of the lamp strings LEDs is OFF, the string has a burned out lamp that needs to be replaced. See section 7.6.5.</p> <p>If both lamp strings LEDs are OFF for any pair of zone switches for the same zone (for instance T1 & T2, B1 & B2), it means that the zone has a blown fuse (most likely, check F33-F35 on the Power Control Schematic 802-101780-01) or an SCR controller (least likely) that needs to be replaced (section 7.9.1).</p>	<u>Zone Switch</u>	<u>LAMP STRINGS</u>	ZONE 1 TOP	T1, T2	ZONE 2 TOP	T3, T4	ZONE 3 TOP	T5, T6	ZONE 1 BOTTOM	B1, B2	ZONE 2 BOTTOM	B3, B4	ZONE 3 BOTTOM	B5, B6	<u>Zone Switch</u>	<u>LAMP STRINGS</u>	ZONE 1 TOP	T1, T2	ZONE 2 TOP	T3, T4, T5	ZONE 3 TOP	T6, T7	ZONE 1 BOTTOM	B1, B2	ZONE 2 BOTTOM	B3, B4, B5	ZONE 3 BOTTOM	B6, B7
<u>Zone Switch</u>	<u>LAMP STRINGS</u>																												
ZONE 1 TOP	T1, T2																												
ZONE 2 TOP	T3, T4																												
ZONE 3 TOP	T5, T6																												
ZONE 1 BOTTOM	B1, B2																												
ZONE 2 BOTTOM	B3, B4																												
ZONE 3 BOTTOM	B5, B6																												
<u>Zone Switch</u>	<u>LAMP STRINGS</u>																												
ZONE 1 TOP	T1, T2																												
ZONE 2 TOP	T3, T4, T5																												
ZONE 3 TOP	T6, T7																												
ZONE 1 BOTTOM	B1, B2																												
ZONE 2 BOTTOM	B3, B4, B5																												
ZONE 3 BOTTOM	B6, B7																												
7. Press the LAMPS red button.	Shuts the lamps OFF.																												
8. Press the CLEAR button on the ALARM panel.	Ends CALIBRATE MODE and returns control of the lamp SCRs to the zone controllers.																												

4.6 Gas Flow Control

The process gas flowmeters are located on the Control Console. The flowmeters control process gas flow to the furnace elements as labeled.

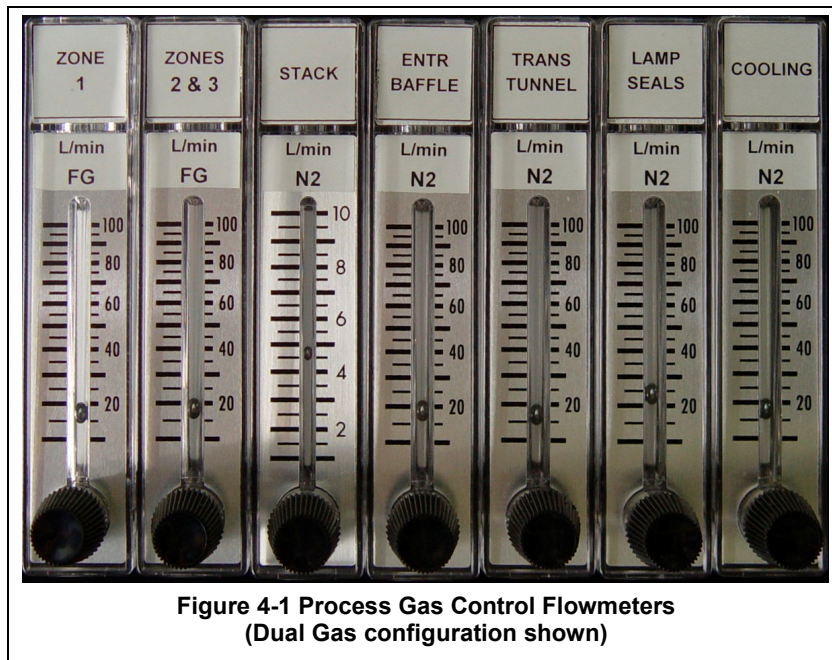

On dual gas furnaces the zone flowmeters are connected to Port 2 gas supply, all other flowmeters are connected to Port 1 gas supply.

On furnace equipped with the SUPPLY GAS MIXING system, the zone flowmeters may receive gas from Port1, Port2 or a mixture of both. See section 3.4 for recommended initial settings. See sections for 8.5 through 8.5.5 for process engineering calculations.

4.6.1 Adjusting Flowmeters

Turn the black flowmeter needle valve knob counterclockwise to increase gas flow and clockwise to decrease gas flow or close the valve completely.

Note: The STATUS ALARMS only report on LOW SUPPLY GAS PRESSURE to the gas manifolds. If the supply gas pressure is adequate, the alarms will NOT indicate absence of sufficient gas flow to the furnace elements even if the flowmeter valves are completely closed.

4.6.2 Indicator Flags

Small plastic indicator flags may have been provided with the furnace to indicate preferred settings.

1. Press the indicator flag into place in front of scale with the red line on the back side next to the scale.
2. Slide the flag from the bottom of the top of the scale and back again 3 or 4 times to remove the mold release agent which is present on the flowmeter.
3. Slide the pointer flag to the desired location and place in service.



MODIFYING CONTROL STRATEGIES

Instructions for changing furnace operating parameters, alert and alarm levels. Includes steps and values for re-entering factory default settings. Refer to chapter 6 for optional equipment.



5.1 Modifying Zone Controllers

Each of the zone controllers in the furnace have been preset for PID operation and tuned for four operating levels. During furnace operation, the controller will automatically select the appropriate PID control loop parameters to use based on the current zone setpoint temperature.

In addition, values for temperature deviation alerts (± 10 °C), an over temperature alarm (1005 °C), and the READY lamp have been preset at the factory. However, during normal operation of a well-balanced furnace, $\pm 1-2$ °C should be expected.

For most applications and users, these settings provide excellent control and process protection. Therefore, the furnace has arrived preset with all controller key pad operation disabled except for changing the zone setpoint temperature using the  ,  and **SET** keys.

5.1.1 Changing the Zone Setpoint Temperature

Adjust the zone controller setpoint using the  or  keys to enter the temperature, and press **SET** key to store the value. The controller output will change immediately after the value is stored. To apply all temperature changes at the same time, press LAMPS OFF button, make and set changes on the zone controllers, then press LAMPS ON button. The SCR “soft start” will limit current in-rush and the temperature changes will proceed smoothly together.





5.1.2 Unlocking and Re-locking Controller Keys

If you need to change any of the controller settings (other than the setpoint temperature), you first must unlock access to the key programming pads.

To unlock the key pad: press **SET** and  keys at the same time. All keys now function.







To relock the key pad from the Main Screen:

Press the  key to access Operation Mode Parameters, and continue:

Parameter (PV display)	Value (SV display)	Action
		Press the  key repeatedly until LoL appears.
LoL	oFF	Press  or  keys to select Lock Mode: oFF The Lock feature is disabled. LoL All key pad operation is ignored. LoL2 All key pad operation is ignored except for  or  keys for changing SV. This is the factory default setting. Press SET button to select choice, then press SET again to return to the Main Screen

5.1.3 Changing Temperature Deviation Alert Limits





From the Main Screen:

Table 5-2 Changing Temperature Deviation Alert Limits		
Parameter (PV display)	Value (SV display)	Action
		Press the  key repeatedly until AL 1H appears.
AL 1H	10	<p>Sets the high limit for the temperature deviation alert. Alert is activated when PV temp reaches SV temp and then will trigger ON if PV temp rises above SV temp + AL 1H</p> <p>Press  and  keys to change this setting. Press SET key to store new value.</p> <p>Press  key for next parameter.</p> <p>Press SET twice to return to the Main Screen.</p>
AL 1L	10	<p>Sets the low limit for the temperature deviation alert. Alert is activated when PV temp reaches SV temp and then will trigger ON if PV temp fall below SV temp - AL 1L</p> <p>Press , , SET,  keys as above.</p>

5.1.4 Changing Over temperature Alarm Limit







Changing this alarm will remove the factory setting of 1005 °C. This upper limit acts to shut down the furnace in the event of an erratic zone or shorted output SCR causing thermal runaway above the 1000 °C furnace design maximum. **While changing this value is not recommended**, the advanced user may wish to set this lower than 1005 °C for use in monitoring a peak temperature limit on one of their thermal processes.

From the Main Screen:

Table 5-3 Changing Over temperature Alarm Limit		
Parameter (PV display)	Value (SV display)	Action
		Press the  key repeatedly until AL 2H appears.
AL 2H	1005	<p>Sets the limit for the over temperature alarm. Alarm is activated when PV temp rises above AL 2H.</p> <p>The factory default setting is 1005 °C to prevent damage to the lamps. The advanced user may wish to set this lower than 1005 °C for use in monitoring a peak temperature limit on one of their thermal processes.</p> <p>When this alarm is triggered, the lamps will shut off.</p> <p>Press  and  keys to change this setting. Press SET key to store new value.</p> <p>Press  key for next parameter.</p> <p>Press SET twice to return to the Main Screen.</p>

5.1.5 Changing READY Light Limits

From the Main Screen:

Table 5-4 Changing READY Light Limits		
Parameter (PV display)	Value (SV display)	Action
		Press the  key repeatedly until AL3H appears.
AL3H	10	<p>Sets the high limit for the READY light.</p> <p>READY will turn ON when the PV temp is within the range of SV temp – AL3L and SV temp + AL3H.</p> <p>The READY light limits are different from the temperature deviation limits.</p> <p>Press  and  keys to change this setting.</p> <p>Press SET key to store new value.</p> <p>Press  key for next parameter.</p> <p>Press SET twice to return to the Main Screen.</p>
AL3L	10	<p>Sets the low limit for the READY green light.</p> <p>READY will turn ON when the PV temp is within the range of SV temp – AL3L and SV temp + AL3H.</p> <p>Note: the READY light limits are different from the temperature deviation limits. The READY green light will turn on only after the furnace is within limits on all 3 zones for a 2-minute period free of alerts or alarms.</p> <p>Press   SET  keys as above.</p>

5.2 Controller PID Tuning

The temperature controllers PID loop parameters are preset at the factory. Before making changes, the user should read and understand section 5.6.1 below. In any case, factory preset values can always be restored, if necessary (see section 5.6 Restoring Factory Presets).

5.2.1 Factory Preset Zone Controller Settings

Quite often a thermal process will change its characteristics notably as it heats up. For this reason, each zone controller can automatically select the most useful PID control loop parameters closest to the desired setpoint temperature entered by the user.

Each zone controller in this furnace can store 4 groups of PID parameter values identified as **PLD0**, **PLD1**, **PLD2** and **PLD3**. Within each group, the PID parameters shown in Table 5-5 can be stored.

Table 5-5 Factory Default Zone Controller PID Parameters								
Zone 1	Group 0		Group 1		Group 2		Group 3	
PID Group Label (read only)	PLD0	250	PLD1	450	PLD2	650	PLD3	850
Setpoint Target	500	250	501	450	502	650	503	850
Proportion Band	P0	50	P1	110	P2	95	P3	95
Integral Time	I0	8	I1	6	I2	10	I3	10
Derivative Time	D0	1	D1	2	D2	2	D3	3
Integral Offset	LOF0	10	LOF1	9	LOF2	50	LOF3	50

Zone 2	Group 0		Group 1		Group 2		Group 3	
PID Group Label (read only)	PLD0	250	PLD1	450	PLD2	650	PLD3	850
Setpoint Target	500	250	501	450	502	650	503	850
Proportion Band	P0	50	P1	40	P2	75	P3	70
Integral Time	I0	8	I1	8	I2	8	I3	8
Derivative Time	D0	1	D1	2	D2	2	D3	3
Integral Offset	LOF0	8	LOF1	35	LOF2	50	LOF3	70

Zone 3	Group 0		Group 1		Group 2		Group 3	
PID Group Label (read only)	PLD0	250	PLD1	450	PLD2	650	PLD3	850
Setpoint Target	500	250	501	450	502	650	503	850
Proportion Band	P0	110	P1	110	P2	100	P3	120
Integral Time	I0	8	I1	6	I2	12	I3	6
Derivative Time	D0	2	D1	2	D2	3	D3	3
Integral Offset	LOF0	4.5	LOF1	9	LOF2	50	LOF3	40

The active group of PID values in use for a particular controller can be either manually selected by the user (**PLD0** – **PLD3**) or automatically selected by the controller (**PLD4**) based on the Setpoint Target closest to the controller setpoint temperature.

The factory has pre-tuned the furnace in each zone for 250 °C, 450 °C, 650 °C and 850 °C and has preset automatic selection in each zone. For most applications, these preset values provide excellent control.

5.2.2 Viewing and Changing a PID Parameter Group

From the Main Screen, press the **SET** key:

Table 5-6 View & Change PID Parameter Group		
Parameter (PV display)	Value (SV display)	Action
AL	OFF	Ignore, press ↩ key for next parameter
PIDn	For PID0-3: nnn For PID4: Auto	PV displays currently active PID Group PIDn and its target setpoint temperature nnn : PID0 is PID Group 0 PID1 is PID Group 1 PID2 is PID Group 2 PID3 is PID Group 3 PID4 is PID Group Auto Select Press ▼ and ▲ key to select active PID group. Press SET , then ↩ key to view/edit PID group. Press SET twice to return to the Main Screen.
SPn	nnn	Target setpoint temperature for selected active PID Group PIDn . Press ▼ and ▲ keys to change this setting. Press SET key to store new value. Press ↩ key for next parameter. Press SET twice to return to the Main Screen.
Pn	nnn.n	Proportion band for selected active PID Group PIDn . Press ▼ ▲ SET ↩ keys as above.
IN	nnn	Integral time (in seconds) for selected active PID Group PIDn . Press ▼ ▲ SET ↩ keys as above.
dn	nnn	Derivative time (in seconds) for selected active PID Group PIDn . Press ▼ ▲ SET ↩ keys as above.
IOF	nnn	Integral offset for selected active PID Group PIDn . This parameter will improve the speed that the PV reaches the SV on furnace startup. Press ▼ ▲ SET ↩ keys as above.
Ignore all other parameters beyond this point. Press SET to return to Main Screen.		

5.2.3 Zone Auto Tuning

Auto Tuning a zone replaces the active PID Group control parameters stored in the zone controller with new values. You can Auto Tune 1, 2 or 3 zones at the same time using this procedure.

Before starting the Auto Tuning process on the furnace,

- CONTROLS should be ON.
- LAMPS should be OFF.
- Set desired setpoint temperature in each zone controller.
- Select the lamps to be energized.
- Set the desired belt speed.

For each controller involved in the Auto Tuning process, select the active PID Group and the target temperature to be changed using Auto Tune. **Caution: Auto tune will replace all factory default values for the zone.**

From the Main Screen, press the **SET** key:

Table 5-7 Zone Auto Tuning		
Parameter (PV display)	Value (SV display)	Action
AL	OFF	Ignore, press ↩ key for next parameter
PIdn	For PID0-3: nnn For PID4: AUTO *	PV displays currently active PID Group PIdn and its target setpoint temperature nnn : PId0 is PID Group 0 PId1 is PID Group 1 PId2 is PID Group 2 PId3 is PID Group 3 PId4 is PID Group Auto Select* * Note: For Auto Tune, select the active PID Group from among PId0 – PId3 only. Press ▼ and ▲ key to select PID group. Press SET key to make PID group active. Press ↩ key to change the target setpoint temperature. Press SET twice to return to the Main Screen.
Sn	nnn	Target setpoint temperature for selected active PID Group PIdn . Press ▼ ▲ SET ↩ key to change target temperature. Press SET key to store target temperature. Press SET again to return to the Main Screen

When back to the Controller Main Screen and ready to start, push LAMPS green button to turn the lamps ON and start heating the furnace.

At any point while the current process temperature (red PV display) is still below the setpoint temperature (green SV display) on the controller, press **SET** key once on the controller to prepare to Autotune the PID loop and proceed as follows:

Table 5-8 Start/Stop Autotune Process		
Parameter (PV display)	Value (SV display)	Action
AT	OFF	Press ▲ key to select ON Press ▼ key to select OFF Press SET to start or stop the Autotuning process.
	ON	Auto Tuning activated. Controller AT indicator turns ON , and the process begins when the process temperature in zone reaches the setpoint temperature. After Auto Tuning is complete, this value returns to OFF , the new PLdn values are stored and normal zone control resumes using those values.
	OFF	Auto Tuning deactivated. If this value is selected during the Auto Tuning process, the controller stops the Auto Tuning process immediately and does not change any PID values.
AT	ON	At any time with Auto Tuning activated, you may press SET to return to the Main Screen while the Auto Tuning process continues. When the controller AT indicator LED turns OFF, Auto Tuning is complete.

These new PID values are stored in the controller permanently in the active PID group, unless they are changed by another Auto Tuning process or by manual change via the controller buttons.

Verify the green READY lamp is on and then return to normal furnace operation, if desired.

Note that the Auto Tuning process will not start until the process temperature reaches the setpoint temperature; if the process temperature is at or above the setpoint temperature, Auto Tuning will never start.

To restore factory default settings, follow the steps in 5.2.2 to manually enter the values found in the tables in 5.2.1

5.3 Automatic PID Group Selection

By selecting PID4 as the active PID Group, the controller will choose automatically the PID0, PID1, PID2 or PID3 group with the target setpoint value closest to the controller setpoint temperature entered by the furnace operator. This mode is factory set as the default mode.

If there are 2 or more PID Groups that have target setpoint values equally close to the setpoint temperature, the controller uses the lowest number PID Group (e.g. if PID Groups 0 -3 have the same target setpoint value, the controller uses PID0 parameters for control).

5.4 Manual PID Group Selection

The user can select PID0, PID1, PID2 or PID3 Group as the active PID group for any controller. See 5.2.2 Viewing and Changing a PID Parameter Group for details. For advanced users only.

5.5 Viewing Controller Output Level

The controllers supply a 0-10 Vdc output control signal to the SCRs to regulate lamp power. To view the controller output level in percent:

From the Main Screen

Table 5-9 View Temperature Controller Output Level		
Parameter (PV display)	Value (SV display)	Action
		Press the  key repeatedly until OUT appears.
OUT	nnn.n	This parameter is a “read -only” display of the controller output over a 0.0 - 100.0% range. Use it to confirm controller output level. Press SET twice to return to the Main Screen.

5.6 Restoring Factory Presets

Zone controllers can be restored to their factory settings by entering and storing the data in the Value column of Table 5-10 and Table 5-11:

5.6.1 Restoring Factory Initial Settings

From the Main Screen:





























Table 5-10 Restore Temperature Controller Factory Settings		
Parameter (PV display)	Value (SV display)	Comments
		Press the SET key and hold for 3 seconds to enter the Initial Setting mode. For each Parameter below: Press ▼ and ▲ keys to change the value. Press SET key to store new value. Press ↻ key for next parameter. Press SET twice to return to the Main Screen.
TCPT	K	T/C type K (-200 to 1300 °C)
TEMP	°C	Temperature units
EP-H	1005	Highest temperature
EP-L	0	Lowest temperature
CTRL	PID	PID control
S-OC	HEAT	Output 1 configuration
ALM1	0	Alarm 1 type
ALM2	6	Alarm 2 type
ALM3	4	Alarm 3 type
SALA	OFF	System Alarm feature disabled
CSM	ON	Allows changes via RS-485 port
C-SL	RTU	Modbus RTU protocol
C-NO	11 12 13	Network address for Zone 1 controller, or Network address for Zone 2 controller, or Network address for Zone 3 controller
BPS	9600	Baud rate
LEN	8	Bit length
PRTY	EVEN	Parity
STOP	1	Stop bit Press SET twice to return to the Main Screen.

5.6.2 Restoring Factory Zone PID Settings

See 5.2.1 for factory zone controller settings. Follow the steps in section 5.2.2 Viewing and Changing a PID Parameter Group to manually re-enter these settings.

5.6.3 Restoring Factory Operation Settings

From the Main Screen:

Table 5-11 Restore Temperature Controller Factory Operation Settings		
Parameter (PV display)	Value (SV display)	Comments
		Press the  key to enter the Operation mode. For each Parameter: Press  and  keys to change the value. Press  key to store new value. Press  key for next parameter. Press  twice to return to the Main Screen.
		Controller run
		Display format (no decimal point)
		Alarm 1 high
		Alarm 1 low
		Alarm 2 high
		Alarm 3 high
		Alarm 3 low
		Lock mode (allows only   &  key entry)
		Setting is read-only and cannot be changed. Press  to return to the Main Screen.

OPTIONAL EQUIPMENT

Features and operation of the most common LA-306 equipment options that may have been included with the furnace or added later. See Table 6-1 for a summary of featured options.

6.1 Options Summary

Option Code	Description	Option Code	Description	Option Code	Description
AFR	Air filter/trap regulator	ELECT-3PH	3-phase power	PH1	25 mm chamber height
AR10	Gas Reservoir	GSM	Supply gas mixing system	PH2	50 mm chamber height (standard, section 1.10)
Belt Speed	Alternate belt speed	HO/NHM	H ₂ operation N ₂ /H ₂ mixing	PH4	100 mm chamber height
CB-3	3-phase circuit breaker	IE	Intermediate exhaust stack	RTL	Right to Left Belt Travel
CE	CE mark	LFI	Line Interference Filter	SENSLAS	Laser product alert system
CXE15	Load station extension	MA	Moisture analyzer	SSP	Sample ports
CXX15	Unload station extension	OA	Oxygen Analyzer	UCD	Ultrasonic belt cleaner
DGO	Dual gas operation	OSS	Gas sampling system	UPS	Uninterruptable Power Supply

6.1 Air Filter Regulator (AFR option)

High volume compressed air filter, moisture trap and pressure regulator to assure supply compressed air is clean, dry and at the proper pressure before entering the furnace. If this option is not selected, customer must assure that an adequate supply of clean dry compressed gas not exceeding 5 bar (70 psig) is connected to the furnace.

6.2 Gas Reservoir (AR10 option)

Pressure vessel for compressed air or nitrogen, 30-56 L (8-15 gal). Acts as a local reservoir to reduce process gas pressure fluctuations. Also can assure that in the event of process gas supply failure, an adequate supply of compressed gas is available to purge furnace of volatile or toxic gases.

Consists of an ASME tank, plumbing, pressure relief valve and drain.

6.3 Alternate Belt Speed (option)

Standard belt speed is 5-500 mm/min. Alternate belt speeds can be offered increasing or decreasing the current min/max belt speed. Special conveyor belt speeds may require changes to motor speed, horsepower and/or gearing for this option.

6.4 Circuit Breaker (CB-3 option □)

A three phase circuit breaker can be installed in an enclosure on the top of the furnace for convenient shutoff of the furnace when not in use. (Figure 6-1). On three phase systems, the standard single phase circuit breaker switch is omitted.



Figure 6-1 3-Phase Circuit Breaker (Option)

6.5 3-Phase Electrical (ELECT-3PH option□)

New in 2013, the LA-306 can be configured for operation on three phase power. Featuring lower energy consumption and faster response time, the furnace can be configured for 208, 220, 380, 400, or 415 Vac three phase voltages (50/60 Hz).

6.5.1 ELECT-3PH Equipment

Adds transformers, 3-phase wiring and logic. Deletes standard single phase circuit breaker switch. See section 6.4 for 3-phase circuit breaker option.

See installation section 2.3 for particulars on 4-wire and 5 wire hookup.



Figure 6-2 3-Phase Electrical (Option)

6.6 European Certification (CE option)

A strict implementation of CE requirements is followed according to the following documents:

Council Directive 2004.108/EC (EMC)

Council Directive 2006/42/EC (MSD)

Council Directive 2006/95/EC (LVD)

Compliance with all safety relevant provisions referring to:

- Controls
- Protection against mechanical hazards
- Required characteristics of guard and protection devices
- Protection against other hazards such as electrical, fire, noise and vibration



Figure 6-3 CE Mark

The following supplemental options must also be added to achieve the standard:

- Operation Manual for European Union (included)
- Circuit Breaker (must purchase CB-3 option separately)
- Line Filter (included)

6.7 Load Extension (CXE15 option)

Increases standard 368 mm (14.5-inch) stainless steel Load station at the entrance of the furnace in 380 mm (15-inch) increments. Useful if a longer product Load area is needed. (Similar to Figure 6-4)

Increases furnace length by a like amount.

6.8 Unload Extension (CXX15 option)

Increases standard 368 mm (14.5-inch) stainless steel Unload station length at the exit of the furnace in 380 mm (15-inch) increments. Used for product inspection or to provide a longer period for product removal.

Increases furnace length by a like amount.



Figure 6-4 Unload station with CXX15

6.9 Dual Gas (DGO option)

Dual gas systems can allow more expensive specialty gas to be introduced into the furnace chamber while another gas can be provided to all furnace auxiliaries.

6.9.1 DGO Equipment

Includes separate manifold for supply of a different gas to the furnace heating zones. Gas 1 can be CDA or nitrogen supplied to eductors, entrance baffle, transition tunnel, lamp seals, and the cooling system. Gas 2 is usually nitrogen, forming gas or other specialty gas (Figure 6-5). The flowmeters may be in a different array to accommodate grouping of zone flowmeters for Gas 2 supply.

An alarm will sound if either Gas 1 or Gas 2 supply is low in pressure. The Control Console Status panel will have an indicating light for each gas area of the furnace.

6.9.2 DGO Operation

A furnace plumbed for dual gas is operated in much the same as a single gas furnace.

1. Operators must assure that gas is flowing from both supply sources.
2. Dual gas systems have a second alert lamp for Gas 2.
3. Typical systems will have nitrogen gas supplied for Gas 1 and forming gas supplied for Gas 2.



Figure 6-5 Control Enclosure showing 3 options: Circuit Breaker; Dual Process Gas; & Sample Port

6.10 H₂/N₂ Mixing (HO/NHM option)

Hydrogen/nitrogen mixing allows hydrogen and nitrogen to be introduced separately into the furnace gas mixing system where it is blended before being introduced into the furnace heating chamber.

6.10.1 HO/HNM Equipment

Hydrogen/nitrogen mixing requires the addition of a special gas mixing console and combustible gas sensors at key points on the furnace as well as additional flow and pressure sensors to assure the hydrogen introduced in an oxygen free furnace environment. Exhaust stack ignitors are also added to harmlessly flame any free hydrogen that maybe evacuated from the furnace.

6.10.2 HO/HNM Operation

Use of Hydrogen (H₂) in the heating chamber requires special furnace owner safety considerations including:

1. Furnace installation ensuring proper ventilation and safe source gases,
2. Special warm up and cool down procedures must be followed.
3. Gas flow balance is critical to the safety of all personnel working near an infrared furnace operating with hydrogen process gas. Escaping hydrogen gas or the admission of oxygenated gas into the process section is extremely hazardous.

These three elements ensure that no additional H₂ gas is allowed into the furnace and that the remaining H₂ is diluted and removed as quickly as possible.

Separate operating instructions will be provided for the HO/NHM option.

6.11 Intermediate Exhaust (IE option)

Adds an exhaust stack after the furnace heating chamber to permit faster evacuation of toxic gases, moisture or undesirables. Also provides for better isolation of the furnace chamber and more sophisticated balancing of the furnace atmosphere, especially important in low-oxygen firing.

6.11.1 IE Equipment

Includes exhaust stack and drip tray in transition tunnel (Figure 6-6). Includes an additional flowmeter dedicated to the transition tunnel eductor labeled TRANS STACK. The flowmeter at the entrance baffle stack will be labeled ENTR STACK on systems with more than one exhaust stack.



Figure 6-6 LA-306 with Intermediate Exhaust

6.11.2 IE Operation

1. Adjust the TRANS STACK flowmeter to achieve the desired evacuation rate of gases from furnace Zone 3 and the transition tunnel, and to prevent gases from the cooling section from entering the furnace chamber.
2. Lower flow may be required at the ENTR STACK flowmeter so that furnace maintains desired balance.

6.12 Supply Gas Mixing (GSM option □)

The GSM system option allows for rapid switching between two gas sources to the furnace heating zones. The GSM system provides pressure regulation of two gas sources at pressures within the range 100-3500 psig down to a furnace operating pressure of 70 psig.

Supply Gas 1 is typically nitrogen (N₂) or air (CDA) and plumbed to all furnace areas including inlet baffle, stack eductor, transition tunnel and cooling section as well as through the Gas 1 flowmeter to the furnace heating zones.

Supply Gas 2 is typically nitrogen (N₂) or forming gas (FG) and plumbed through the Gas 2 flowmeter to the furnace heating zones.

6.12.1 GSM Equipment

The GSM system includes two (2) high flow 0-3500 psig pressure regulators each with a 0-100 psi pressure gauge and flowmeter. Users can adjust for 100% forming gas to the furnace for critical reducing operations and later quickly switch to nitrogen to conserve higher cost specialty gas. User can also adjust flowmeters to increase amount of nitrogen in the forming gas mix (Figure 6-7).

The system can be ordered with alternate pressure ranges.

6.12.2 GSM Operation

To operate the furnace with Gas1 only (nitrogen):

1. Adjust Gas1 pressure.
2. Open Gas1 flowmeter and adjust Gas1 pressure to 70 psig.
3. Close Gas2 flowmeter.

To operate with Gas2 (forming gas) to furnace zones, Gas 1 to furnace auxiliaries:

1. Adjust Gas2 pressure.
2. Open Gas2 flowmeter and adjust Gas2 pressure to 70 psig.
3. Close Gas1 flowmeter.

To operate with both Gas1 and Gas2 to furnace zones, Gas 1 to furnace auxiliaries:

1. Adjust Gas1 and Gas2 pressure.
2. Open Gas1 flowmeter and adjust Gas1 pressure to 70 psig.
3. Open Gas2 flowmeter and adjust Gas2 pressure to 70 psig.
4. Adjust Gas1 and Gas2 flowmeters to achieve volume percent balance of gas entering the furnace chamber. Both should read the same pressure to assure even mixing.

NOTE: Note: Each GSM flowmeter is sized to accommodate full flow to all zones through the furnace. Consequently when the individual zone flowmeters on the Control Console are at low settings, the flow through the larger Gas1 and Gas2 flowmeters may appear to near zero if the sum of the flow is near the minimum operating range of the flowmeter (minimum is 10% of full flow).

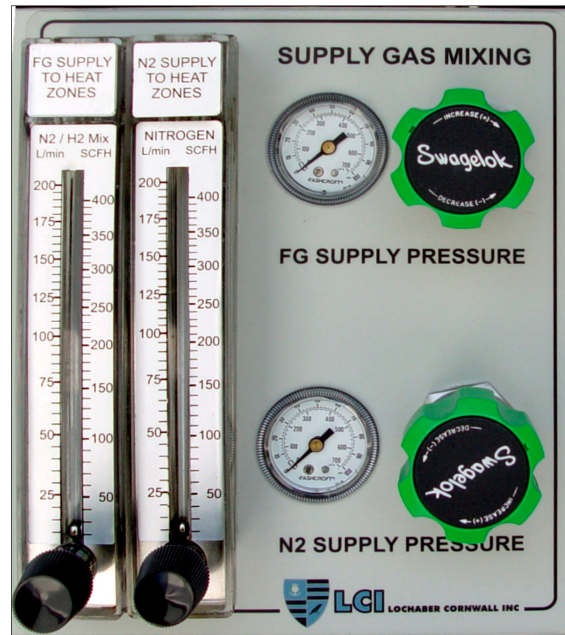

Figure 6-7 Supply Gas Mixing System Control Panel

6.13 Line Filter (LFI option □)

An AC power line interference filter reduces the potential electrical interference generated by SCRs and motor controls within the furnace. Compliant with IEC 60950. This option is included on furnaces with the European CE option.

6.14 Moisture Analyzer (MA option □)

For processes that are sensitive to moisture, a moisture analyzer can provide status of monitored zones.

The moisture analyzer can be connected to any one sample port (with SSP option) or can be used with a 3-port sample system (OSS option).



Figure 6-8 MM510 Moisture Analyzer

6.14.1 MA Equipment

The brand of moisture analyzer can generally be specified by the owner. A high quality choice, the MM510 electrolytic moisture analyzer is designed for precise measurement of moisture in gas over a wide range (0.1 ppm to 1000 ppm with $\pm 5\%$ accuracy). The analyzer is configured with an internal sample pump. The sample systems are manufactured using stainless steel throughout with 1/8-inch tube connections on the sample line. Sample flow is 0.05-0.5 L/min (50-500 cc/minute) controlled.

MM510 Sensor. The phosphorus pentoxide moisture sensor consists of a dual platinum winding formed around a quartz tube about 8 cm long. A constant voltage is applied across the windings and the current monitored. The moisture in the sample gas stream causes the resistance of the platinum coil to change. The change in resistance results in a change in measured current providing an absolute measure of the moisture contained in the process sample gas. Unlike aluminum oxide sensors, the phosphorus pentoxide sensor does not require annual factory calibration.

6.14.2 MA Operation

The model of moisture analyzer selected will be factory set for your application.

1. Startup of the furnace will start the moisture sampling if the analyzer is left enabled by the operator.
2. A switch on the back of the analyzer allows shutoff of the analyzer while the furnace is running, if desired.
3. Sample line flow is controlled by the valve knob on the back of the analyzer Adjust to 0.15 L/min

6.15 Oxygen Analyzer (OA option □)

An oxygen analyzer can assure furnace settings result in a low oxygen environment in the furnace chamber during operation.

6.15.1 OA Equipment

The brand of moisture analyzer can generally be specified by the owner. A high quality choice, the EC913 process oxygen analyzer uses an electrochemical RACE™ cell for accurate measurement of oxygen (measuring range: 0.1 ppm-30% at $\pm 2\%$) and features microprocessor controlled functions, large auto-ranging LED display, and fast response. To avoid interference, indicate if hydrogen gas will be present.

The analyzer is fitted with an integral sample pump downstream of the sensor. The sample Out valve on the back of the analyzer is used for flow control and is adjustable from 0.05-0.5 L/min (50-500 cc/min) sample rate (default is 0.1 to 0.15 L/min).



Figure 6-9 EC913 Oxygen Analyzer

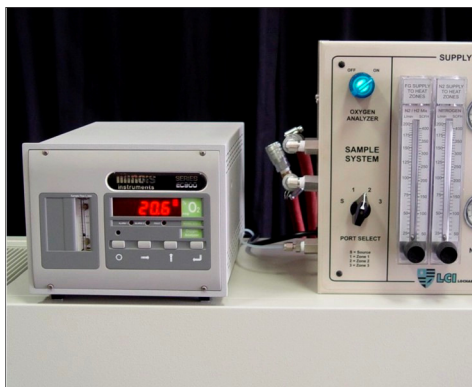

Figure 6-10 Oxygen Analyzer with OSS



Figure 6-11 Oxygen Analyzer next to Control Console

6.15.2 Analyzer Initial Setup (without OSS)

1. Open IN valve full CCW (on back of analyzer, Figure 6-12).
2. Enable analyzer by turning Power Switch on back of analyzer to ON position.

Note A: In this configuration, analyzer will start and stop with furnace CONTROLS switch.

6.15.3 OA Operation (without OSS)

1. Start furnace.
2. Press Controls ON to energize Sample System and to start analyzer.
3. Adjust lower OUT valve (only valve on newer analyzers) CCW until Sample Flow flowmeter on front of analyzer reads 0.10 - 0.15 L/min (Figure 6-12).
4. Wait until sample line has been completely refreshed with new sample gas (usually 2-5 minutes at startup).

Note A: When the sample line is dry, accurate readings can be obtained within minutes. If the sample line contains moisture, it may take from 20 minutes or longer. Moisture may be purged from the sample line by disconnecting the line from the analyzer and using a dry gas (nitrogen) to flush the line. Be careful to keep the pressure under 2.5 bar (35 psig) to avoid disconnecting the sample line from the furnace.

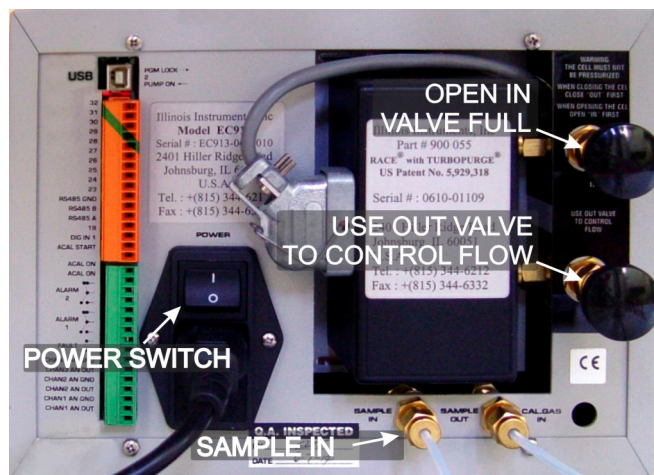

**Figure 6-12 EC913 Oxygen Analyzer Rear View
Pre-2016 Analyzers**

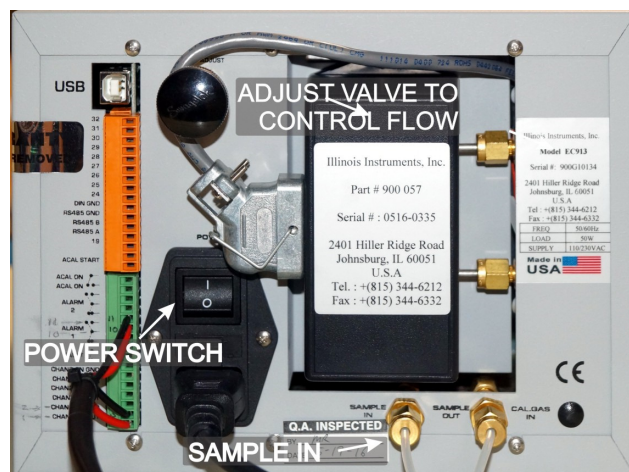

**Figure 6-13 EC913 Oxygen Analyzer Rear View
2016 and Later Analyzers**

6.15.4 Shut Down Analyzer (without OSS)

If the analyzer is to be out of service for a period of time, isolate the cell to prolong its life:

1. Close OUT valve first (only valve on newer analyzers) on back of analyzer (to isolate cell).
2. On older analyzers, close IN valve on back of analyzer (to isolate cell).

Note A: Analyzer valves can be left in open position while connected to the LA-306 as the sample port manifold will isolate the analyzer cell from gas flow when the system is off.

Note B: To prolong cell life, limit sampling of air. Close valves on back of analyzer to isolate the cell.

6.15.5 Startup Operation and Shutdown with OSS

See section 6.16 OSS Option for OA oxygen analyzer initial setup, operation and shutdown with the Oxygen Sampling System.

6.16 Sample System (OSS option)

The OSS option provides user selection of any one of 3 furnace ports or the source gas (nitrogen) to a sample gas line to the gas analyzer equipment (typically moisture and/or oxygen analyzer).

6.16.1 OSS Equipment

This system consists of electrical controls and piping of a 4-port manifold to a source gas and 3 sample ports. The sample ports are located on the bottom of each furnace chamber zone. The Source is piped from Gas 1 (or the nitrogen source) through a pressure regulator adjusted to 35 mbar (0.5 psig) and connected to port 1 on the manifold.

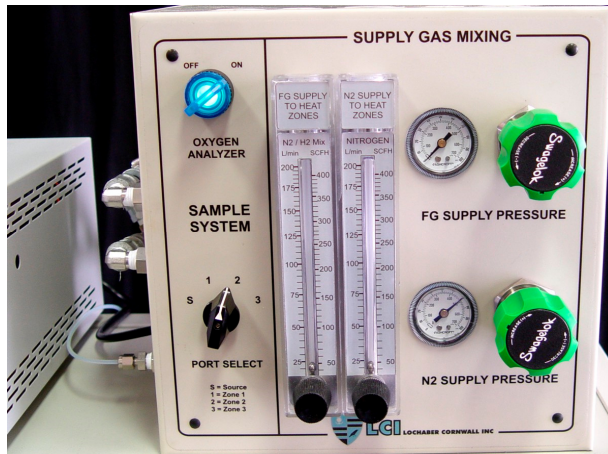

Figure 6-14 Sample System control panel (shown with Supply Gas Mixing System)

6.16.2 Analyzer Initial Setup (with OSS)

1. Enable analyzer by turning Power Switch on back of analyzer (Figure 6-12) to ON position.
2. On back of analyzer open IN (Figure 6-15, it is the only valve on newer analyzers, Figure 6-13) valve full CCW.

Note A: In this configuration, analyzer will start and stop with furnace CONTROLS switch.

6.16.3 OA Operation (with OSS)

1. Turn blue selector switch ON.
2. Select port to be sampled.
3. Start furnace.
4. Press Controls ON to energize Sample System and start analyzer.
5. Adjust OUT valve until Sample Flow flowmeter on front of analyzer reads 0.1-0.15 L/min (Figure 6-15).

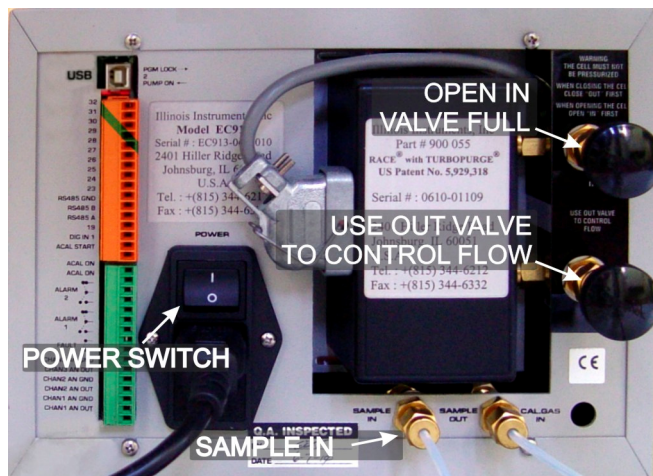

Figure 6-15 EC913 Oxygen Analyzer Rear Controls Pre-2016 Analyzers (Newer, see Figure 6-13)

Note A: When the sample line is dry, accurate readings can be obtained within minutes. If the sample line contains moisture, it may take from 20 minutes or longer. Moisture may be purged from the sample line by disconnecting the line from the analyzer and using a dry gas (nitrogen) to flush the line. Be careful to keep the pressure under 2.5 bar (35 psig) to avoid disconnecting the sample line from the furnace.

Note B: When nitrogen is connected to Gas 1, Port Select S will sample the source nitrogen. Ports 1, 2 and 3 sample the respective furnace zones.

6.16.4 Shut Down Analyzer (with OSS)

If the analyzer is to be out of service for a period of time, further isolate the cell to prolong its life.

1. If system is not equipped with a check valve on the Sample OUT line, close OUT valve (only valve on newer analyzers) on back of analyzer (to isolate cell).
2. On older analyzers, if analyzer is disconnected from the OSS, Close IN valve on back of analyzer also.

Note A: Analyzer valves can be left in open position while connected to the LA-306 as the sample port manifold will isolate the analyzer cell from gas flow when the system is off.

Note B: To prolong cell life, limit sampling of air.

6.17 Chamber Height, 1-in (PH1 option)

Standard clearance throughout the furnace chamber, baffles and cooling sections provide for a 50 mm (2-inch) clearance for product travelling on the belt. The furnace can be ordered with a chamber height of 25 mm (1-inch) to improve heating profile characteristics. With a smaller heating cavity and smaller internal volume throughout, the PH1 option offers energy and process gas savings. Owner can stipulate entrance baffle and transition tunnel baffle clearance of 6 mm to 13 mm (0.25 to 0.5 inches) above the belt (or eliminate entirely).

6.18 Chamber Height, 4-in (PH4 option)

Standard clearance throughout the furnace chamber, baffles and cooling sections provide for a 50 mm (2-inch) clearance for product travelling on the belt. The furnace can be ordered with a chamber height of 100 mm (4-inch) to allow for processing taller product. With a larger heating cavity and larger internal volume throughout, the PH4 option will consume more energy and process gas. Owner can stipulate entrance baffle and transition tunnel baffle clearance of 6 mm to 90 mm (0.25 to 3.5 inches) above the belt (or eliminate entirely).

6.19 Belt Travel, Right to Left (RTL option)

The furnace can be configured so the belt travels from right to left when facing the control panel. This option is useful when furnaces are located opposite one another in parallel production lines. Allows one operator to manage furnaces in two production lines (one standard LTR and one RTL).

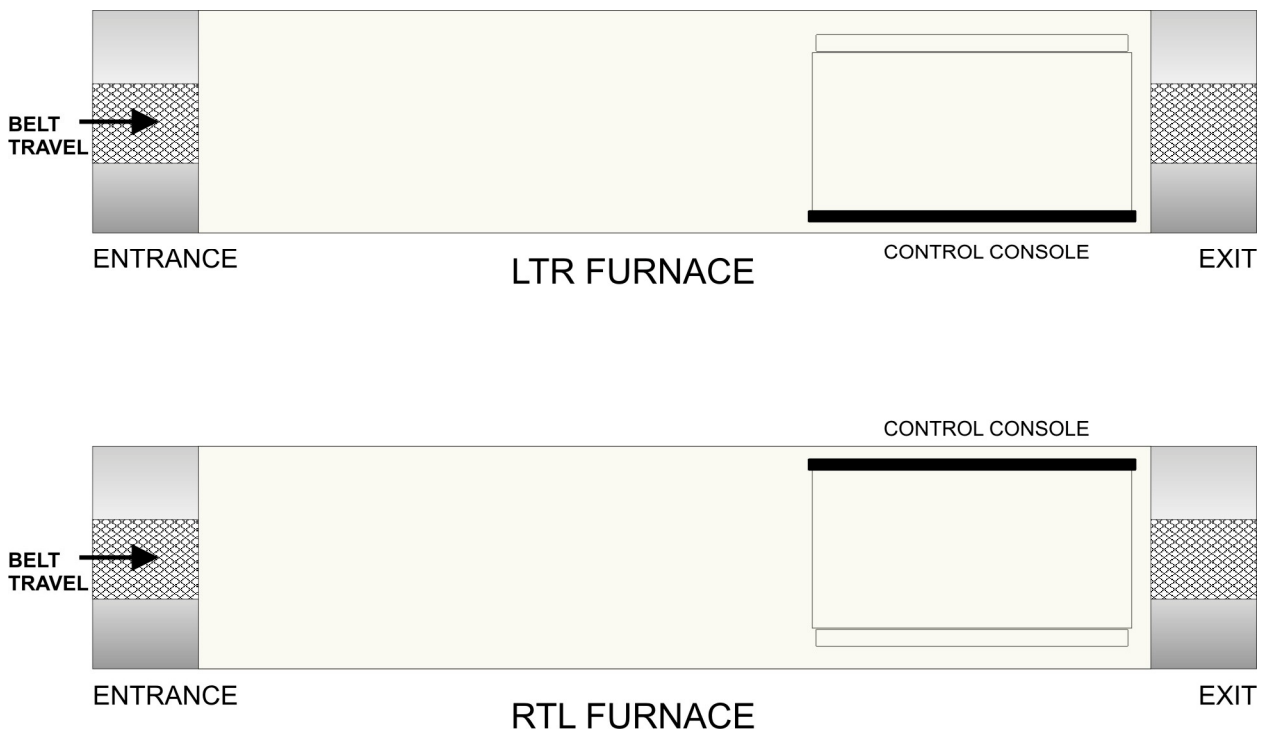

Figure 6-16 LTR and RTL Furnaces

6.20 Product Alert (SENSLAS option)

The SENSLAS system alerts operators when product exits the furnace. For longer processes, operators can perform other tasks in the same work area and respond when product appears at the furnace Unload station (Figure 6-17).

6.20.1 SENSLAS Equipment

This system consists of a laser sensor and audible chime with volume control. The SENSLAS system is conveniently controlled at the vertical face of the furnace exit. The sensor is mounted on an adjustable bracket approximately 74 mm (3-3.5 inches) from the furnace exit (Figure 6-19).

6.20.2 SENSLAS Operation

Activate the system using the lighted switch. Each time product passes under the sensor, the Clear button lights and a gentle audible chime continues to sound until the Clear button is pressed. Turning a four position selector switch changes the volume of the chime from quiet to loud. To disable the system, turn the ON/OFF switch counter-clockwise (Figure 6-18).

1. Turn the SENSLAS Off/On clockwise.
2. Place hand under laser sensor and adjust the volume selector (1=low, 4=high) to desired sound level.
3. When parts pass under sensor, chime will sound and clear button lights until reset.
4. Press CLEAR button to reset chime.

When enabled, the system can be switched on and off at the furnace Control Console when either of the CONTROLS buttons is pressed.

6.20.3 Sensor Calibration

The sensor can be calibrated using two objects: a sample of the product (foreground) and a thin flat sheet of metal or other material (background).

1. Turn on the SENSLAS system.
2. Set the belt at a slow speed (125-250 mm/min (5-10 ipm)).
3. Place the two objects in line just before the laser sensor with background object on the center of the belt first immediately followed by the foreground object.
4. As the background object passes under the laser beam, press calibrate button on the side of the sensor for less than 1 second Figure 6-19.
5. As the foreground object passes under the sensor press the button again for less than 1 second.
6. The sensor is now calibrated to sense objects between the height of the background and the foreground.



Figure 6-17 SENSLAS System



Figure 6-18 SENSLAS Control Panel

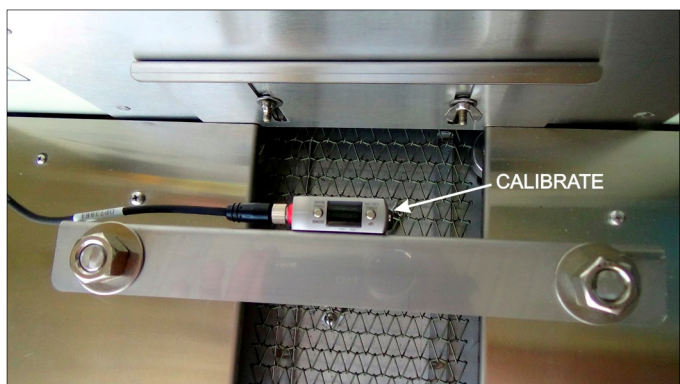

Figure 6-19 Calibrate Sensor

6.21 Sample Ports (SSP option □)

Allows connection of an oxygen analyzer, moisture analyzer or other gas analyzer. Must be used with a sample pump (not included).

This option includes a drilled and shrouded sample port connection located on the underside of one or more zones (see Figure 6-20 and Figure 6-21 Zone Port Locations). Also includes plumbing to the Control Enclosure or OSS enclosure for easy analyzer hookup. See typical port for analyzer sample line connection in Figure 2-20 and Figure 2-21. Figure 6-5 shows analyzer port connection on a RTC LA-306.

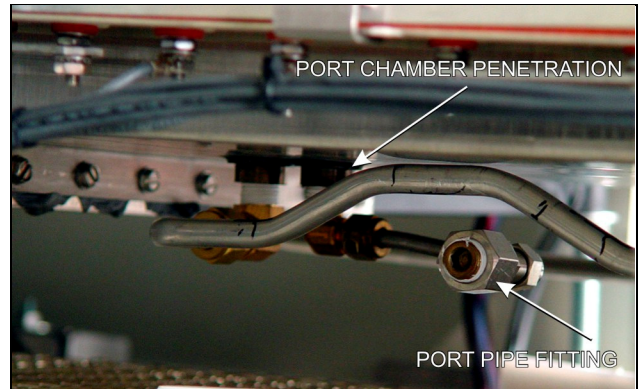

Figure 6-20 Sample Port Chamber Penetration

SSP is included for 3 ports standard in the OSS option.

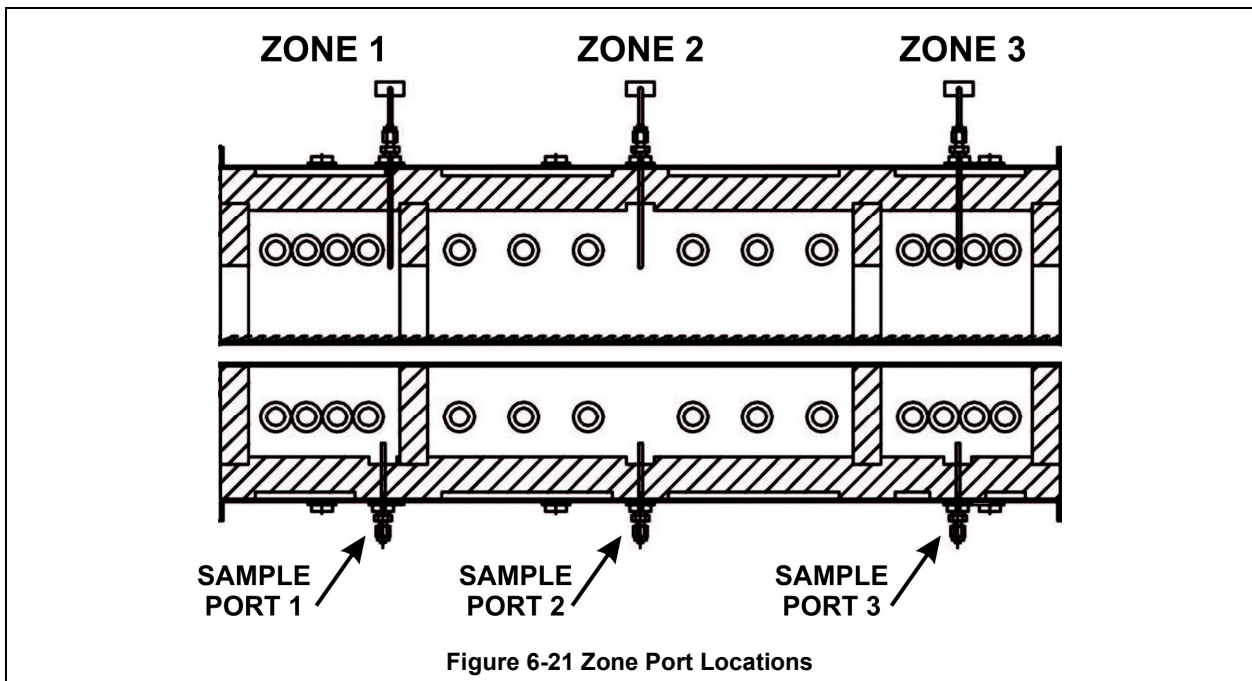

Figure 6-21 Zone Port Locations

6.22 Ultrasonic Cleaner (UCD option ☐)

The ultrasonic belt cleaning system removes contamination that accumulates on the belt during normal furnace operation.

6.22.1 UCD Equipment

This system includes an ultrasonic tank, belt dryer and timer system to enable automatic cleaning of the belt. A fan-driven air dryer removes water droplets and can be provided with an optional heater to further drive moisture from the belt. The ultrasonic belt cleaning system removes contamination that accumulates on the belt during normal furnace operation. This system includes an ultrasonic tank, belt dryer and timer system to enable automatic cleaning of the belt. A fan-driven air blow-off removes water droplets and can be provided with an optional heater to further drive moisture from the belt. The belt is drawn through an ultrasonic tank that is automatically filled and drained by a timer and control circuitry. The cleaning/drying of the belt takes place when the furnace is off-line. This option requires connection to facility water source and water drain.

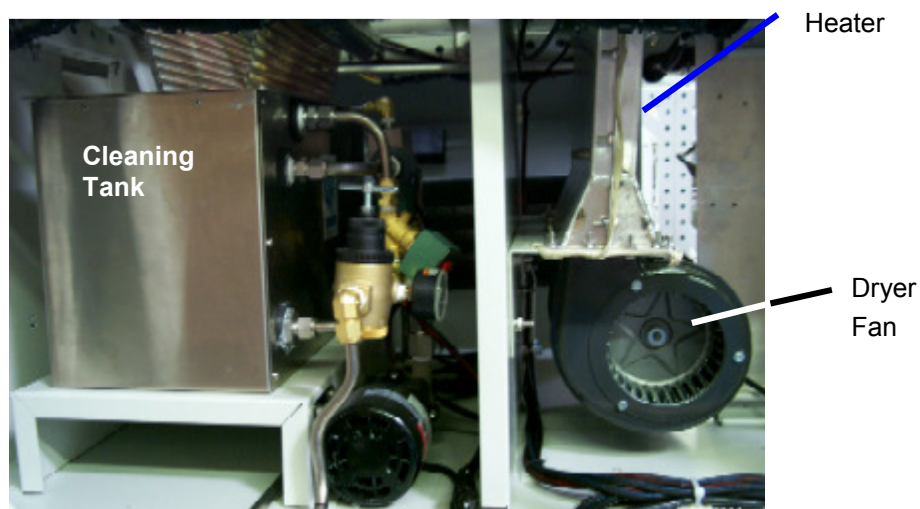

Figure 6-22 Ultrasonic Cleaner installation

6.23 Uninterruptable Power Supply (UPS option☐)

This option adds an uninterruptable power supply to keep the belt, fans, and control system running for at least twenty minutes during a power outage. The transport belt continues to run at set speed which minimizes product loss during brief power failures. The unit automatically switches from standby to process start upon restoring power, whether provided by generator backup or city power.

SERVICE & MAINTENANCE

7.1 Service and Maintenance Access

INTERLOCKED PANELS. Interlock switches will cut power to the furnace when the panel is removed or opened. Interlocks are located on the entrance lower panels on both the front and back of the furnace. In addition, the control enclosure rear access door is interlocked. The control enclosure top access plate is not interlocked.

Observe extreme caution when the furnace power is engaged while the access panels are removed. Dangerous levels of AC and DC voltages will be present.

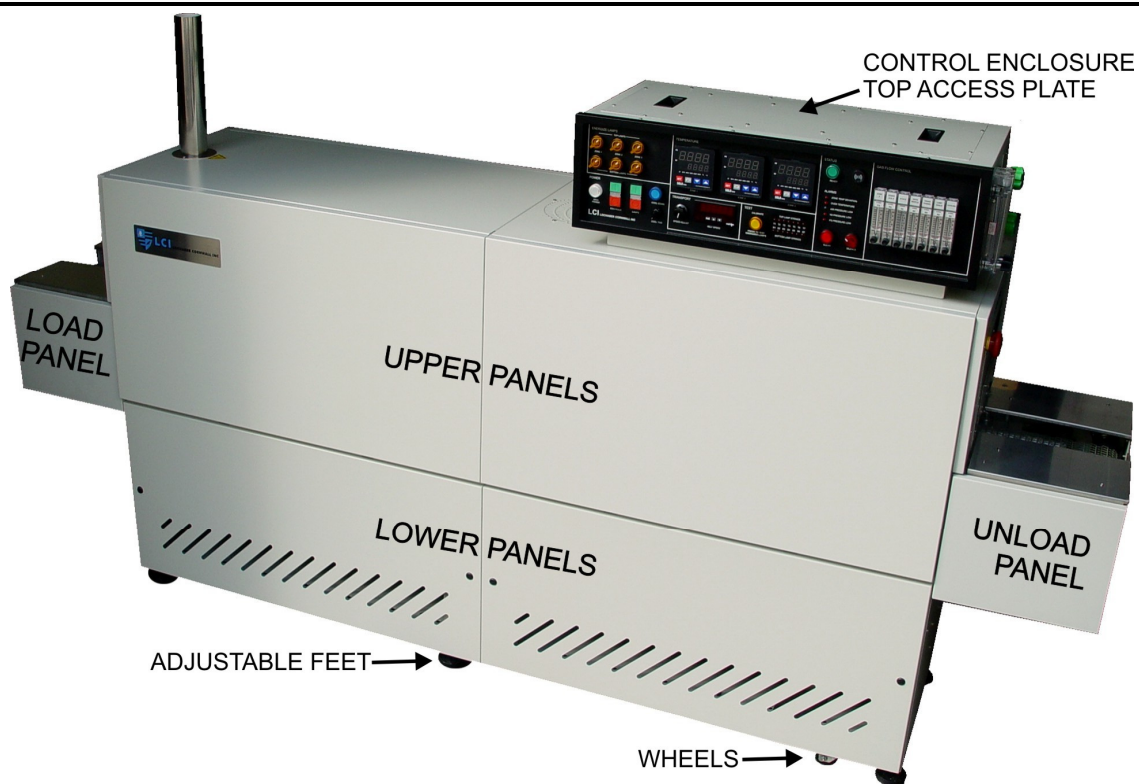

Figure 7-1 Front Access Panels

LOWER PANELS. Gain access to the lower sections of the furnace by turning the quick release screws and removing the panels (see Figure 7-6 and Figure 7-7). For convenience, lower panels can be rotated and hung from the slots in the upper panels during service (see Figure 7-8). Make sure the EPO interlock switches (Figure 7-10) on the front two lower electrical panels are pulled out if the furnace is to be energized while these lower panels are off.

When a panel that houses an optional Disconnect Switch is removed, turn the switch to off to disengage the switch and allow removal of the panel.

UPPER PANELS. Once the lower panels have been removed, the upper side panels can be lifted and removed. Upper panels can be hung from adjacent upper panels (see Figure 7-9). When replacing the upper panels carefully lower the top of the panel into the slot provided and insert the bottom of the panel so it is resting on the stainless steel shoulder screws (see Figure 7-10).

CONTROL ENCLOSURE. To gain access to control system components including SCR's pressure switches, temperature controller and belt speed tachometer, open drop down door and/or top access panel. To open interlocked dropdown door, remove the 4 machine screws along rear top shown in Figure 7-4. To remove control enclosure top access panel, remove screws along its perimeter. This panel is not interlocked. Caution dangerous voltages are present in the control enclosure when power is connected to the furnace.

Chapter 7

COOLING SYSTEM. Remove lower and upper front or rear exit panels to access cooling system.

LOAD/UNLOAD PANELS. These panels located on either side of the furnace near the entrance and are not interlocked. Remove either panel to gain access to transport drive rollers. Remove rear adjacent to service an owner-installed UPS (if so equipped).

FURNACE DRIVE ENCLOSURE. Remove side panels at exit to adjust the belt tracking.

HEATING ELEMENTS. Remove entrance UPPER side panels near entrance to access lamp elements.

UCD AND CDA FILTERS & REGULATORS (optional). Remove side lower panels to access the Ultrasonic Cleaner Dryer tank heater, solenoids, water regulator and CDA filter and regulators if so equipped. Remove lower electrical panel near the exit to access Ultrasonic Generator (if so equipped).

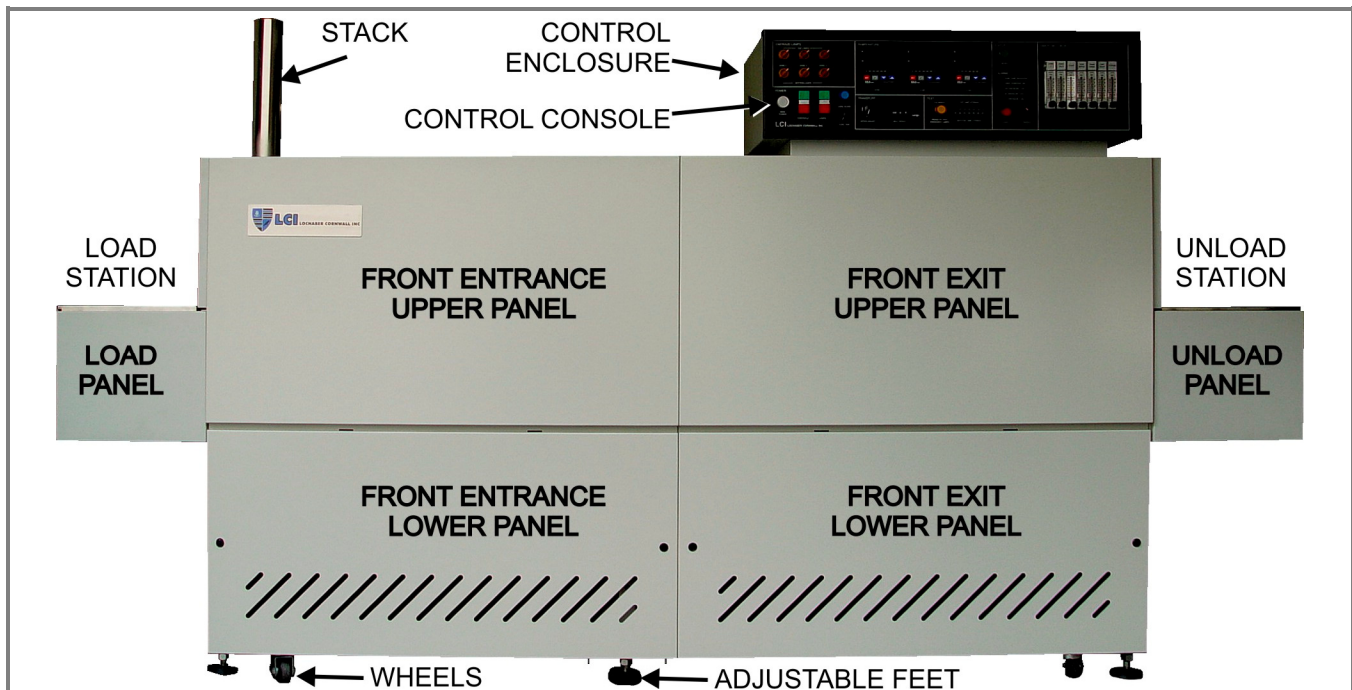

Figure 7-2 Front Access Panels

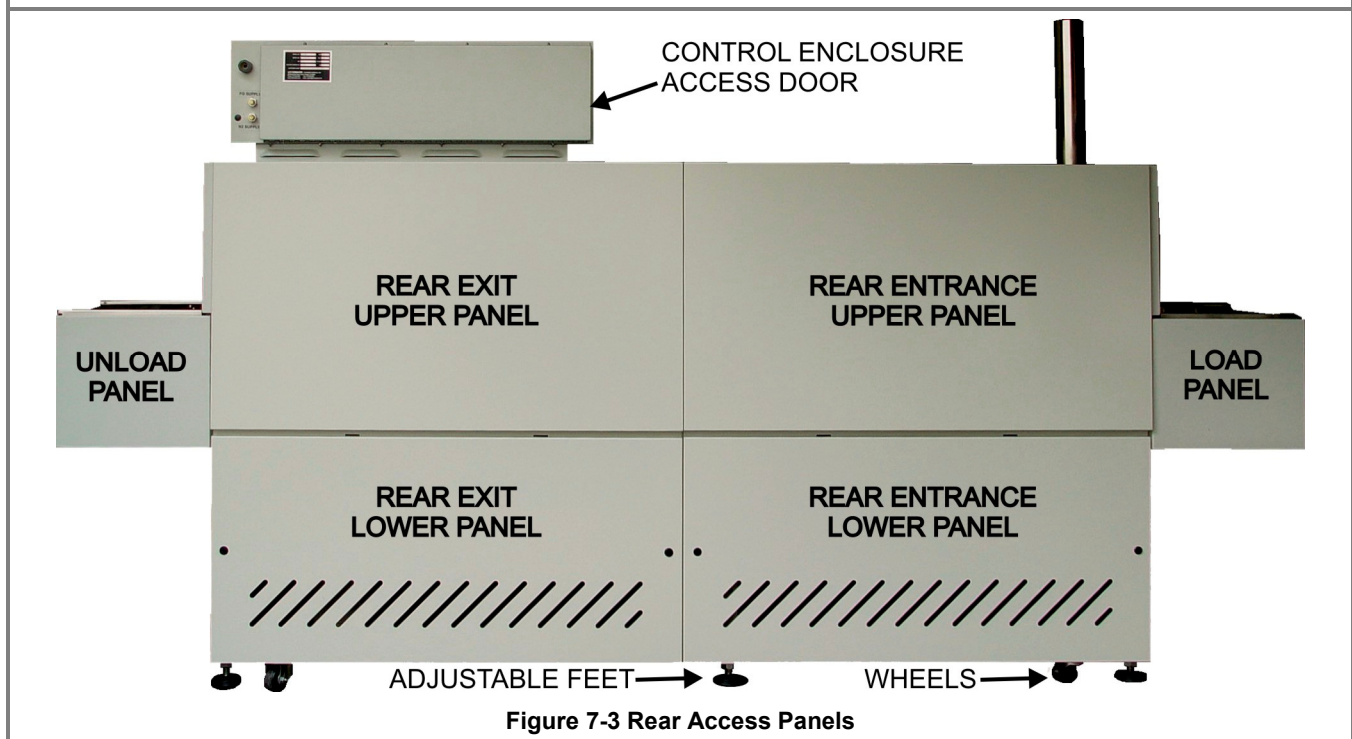

Figure 7-3 Rear Access Panels



Figure 7-4 Control Enclosure Access Door Closed

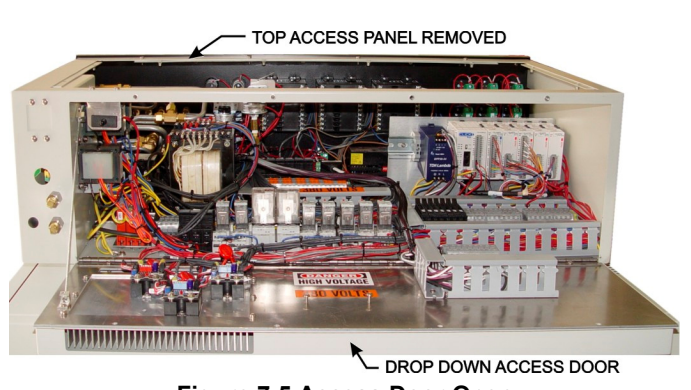

Figure 7-5 Access Door Open

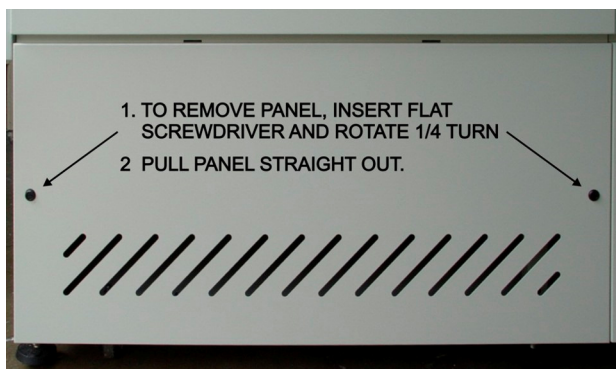

Figure 7-6 Lower Access Panel Removal

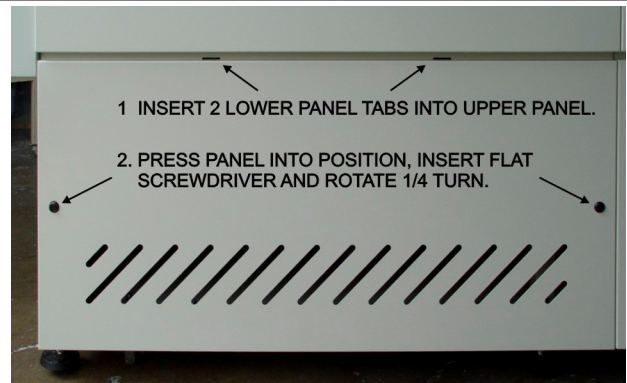

Figure 7-7 Lower Access Panel Installation



Figure 7-8 Hanging Lower Access Panel



Figure 7-9 Hanging Lower Access Panel

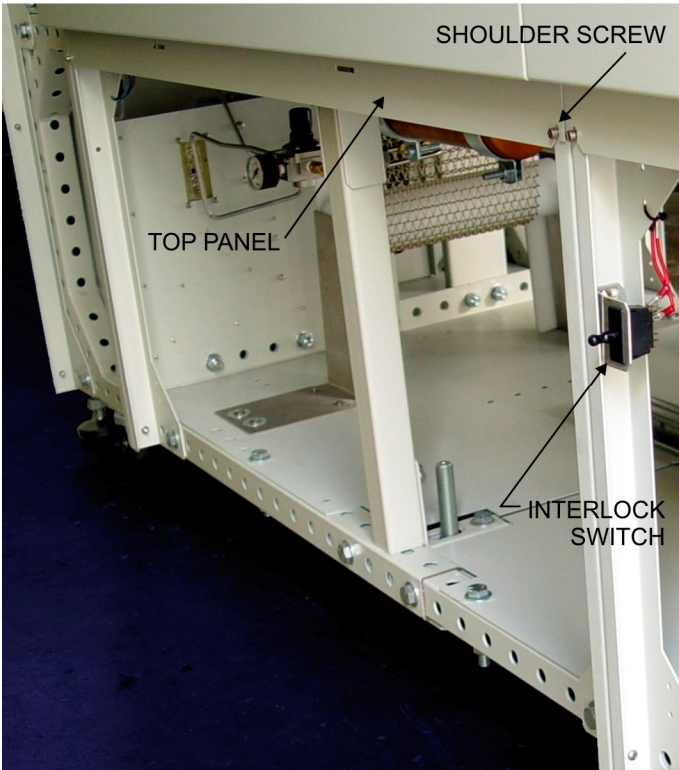

Figure 7-10 Top Panel In Place



Figure 7-11 Entrance Panels



Figure 7-12 Drive Enclosure Access Panels

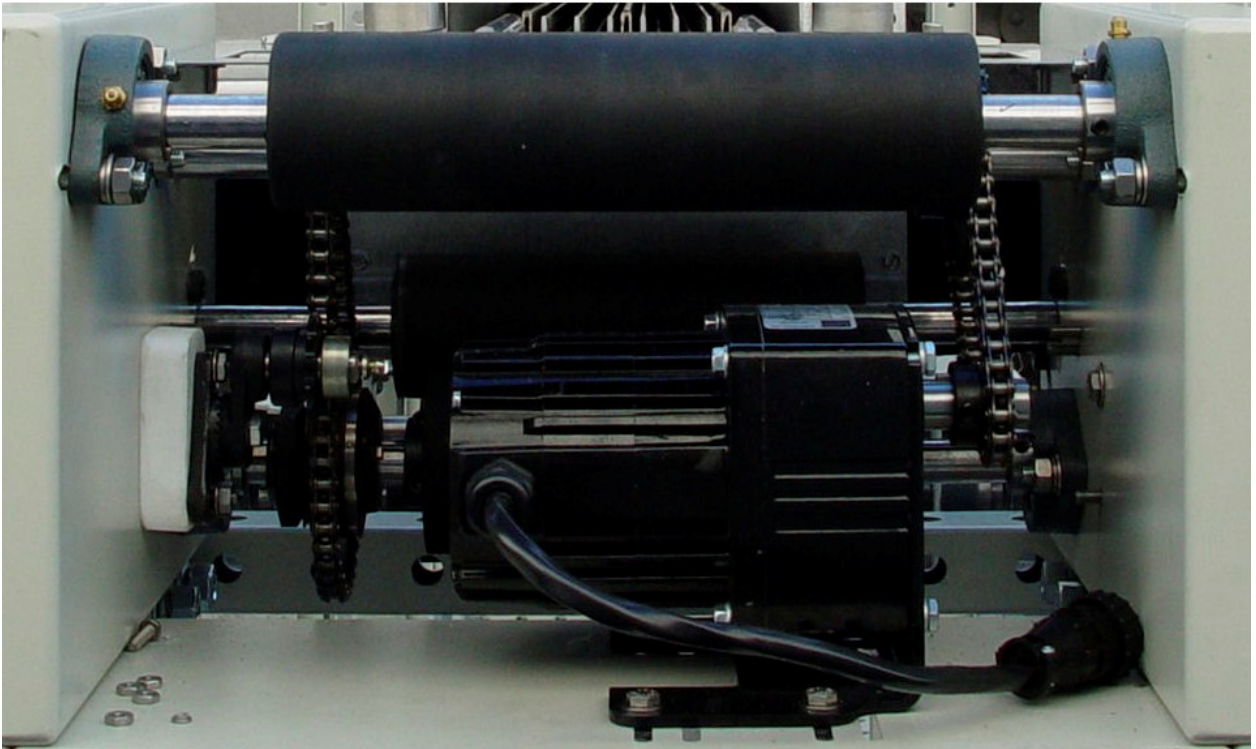

Figure 7-13 Transport Drive (at Furnace Exit)

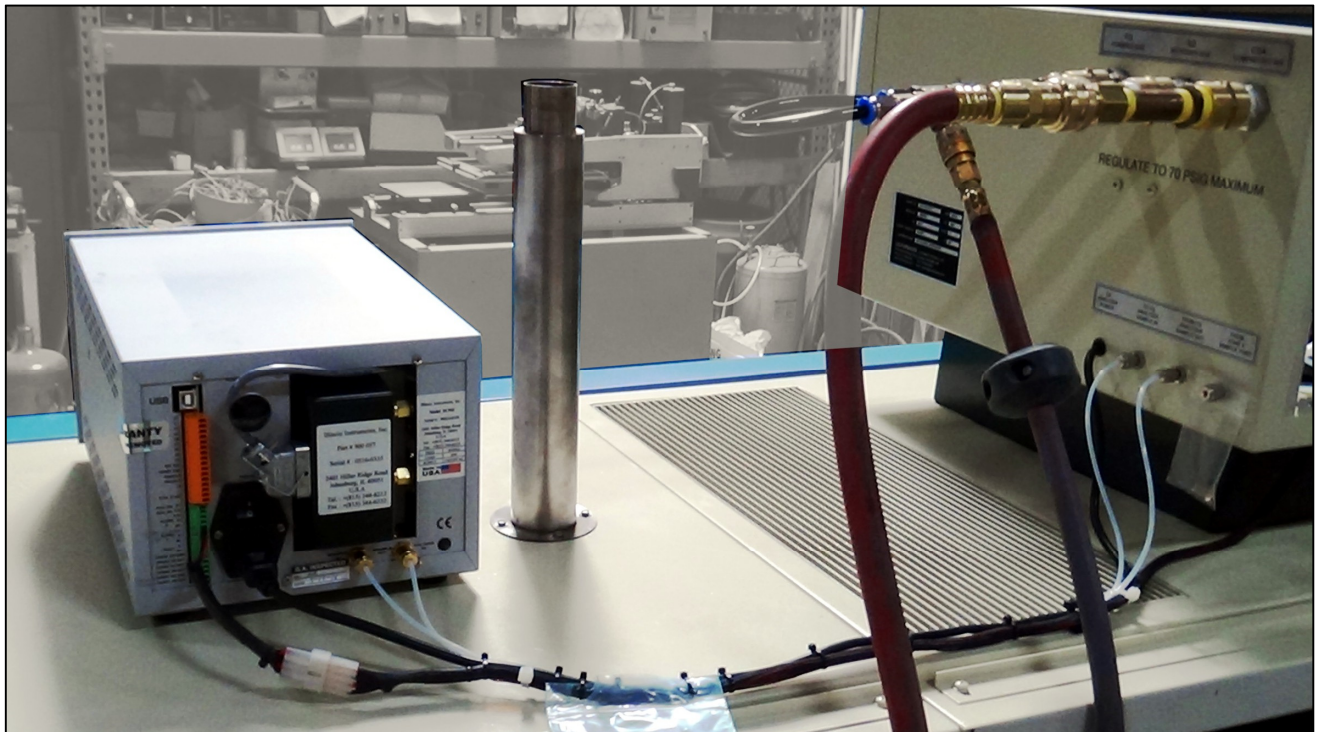

Figure 7-14 Typical Oxygen Analyzer furnace connections



Figure 7-15 O2 Analyzer-front view



Figure 7-16 O2 Oxygen Analyzer rear view
Newer Model Analyzers

7.2 Routine Maintenance

Generally external cleaning is all that is required. The chambers should not be touched or removed. If chamber cleaning is required, contact FurnacePros.

WARNING. DO NOT ATTEMPT TO OPEN OR MANUALLY CLEAN THE CHAMBERS OR THE FURNACE MAY BE INOPERABLE DUE TO DAMAGE TO THE INSULATION. Contact the manufacturer if cleaning is required.

7.3 Daily Maintenance

Daily maintenance consists of a series of functional checks that will alert maintenance personnel to any signs of developing problems. The importance of regularly checking the machine cannot be over stressed to prevent not only damage to the machine, but also loss of productive time and product. Whenever the furnace is started up the failure alarms should be checked for signs of trouble. All alarm functions should be monitored, such as the lamp failure indicator, to see if corrective action is required. While the machine is being started, each control and switch should be briefly checked to ensure that all functions are working properly. Any controls that do not respond as expected, or alarms that do not clear should be investigated and corrected before putting the machine into operation.

7.4 Monthly Maintenance

Monthly maintenance, in general, means four weeks of operation for one eight-hour shift per day. This period of operation is not an absolute number, and it is possible that some of the tasks are needed more or less often. Experience with the machine and process being performed should dictate the need.

Note: Run a temperature profile, no less often than monthly, on machines that are used for sensitive processes.

On machines that are used for a variety of products, it is advisable to set up a profiling schedule so that each process can be checked periodically. In general, the most sensitive profiles should be checked at least monthly, while less sensitive profiles could be checked every 2-6 months. However, consistency of profiling results may indicate more or less frequent profile checks.

7.5 Other Recommended Maintenance

Table 7-1 lists furnace equipment and maintenance tasks and recommended intervals. Many of these items are optional equipment and may not be found on your furnace. In many cases visual inspection can determine whether any preventative maintenance is required. Often maintenance intervals are determined by the process and furnace use.

Table 7-1 Recommended Maintenance & Frequency

Equipment	Recommended Maintenance	Recommended Interval
Air Filters, Compressed air	<p>Remove the door panel below the flowmeters and replace filter set in the compressed air line to assure furnace receives clean dry air.</p> 	6 months or as required.
Compressed Air Tank (optional)	<p>With air pressure still on the furnace system, remove the door panel below and to the left of the flowmeters. Open the small valve for the air compressor reservoir drain. Purge the tank until the condensate has been removed.</p> 	Monthly or as required.
Belt Shaft Bearings-perm	<p>To gain access to the belt shaft bearings remove the end covers from both ends of the machine. Located at both ends of each belt shaft are permanently-lubricated bearings. These bearings should not be lubricated.</p>	None
Belt Shaft Bearings with grease fittings	<p>Bearings with grease fittings should be lubricated with general multipurpose bearing grease. Apply enough grease to the bearing block until excess grease can be seen squirting out along the shaft of the device. Wipe off all excess grease to avoid dirt accumulation.</p>	3 years
Belt Shaft Rollers	<p>The belt shaft rollers should be inspected periodically to make sure that they are centered on their respective shafts. Remove the end covers to gain full access to the belt shaft rollers. If a roller is misaligned, loosen the setscrews that hold the roller onto the shaft and use a rubber mallet to move the roller on its shaft. Use a scale to make sure the rollers are centered to within 0.125 inches on the belt shaft.</p> 	After first 30 days, annually thereafter

Table 7-1 Recommended Maintenance & Frequency

Equipment	Recommended Maintenance	Recommended Interval	
<p>Belt Tracking Adjustment</p>	<p>The belt should be checked periodically to make sure that it is tracking through the center of the oven. Belt tracking can be checked visually at the entrance and exit ends of the oven. The belt should be centered between the belt guides at the entrance and exit ends of the oven. If the belt tracks off-center this problem can be rectified by realigning the belt shafts. First, set the belt speed to zero and remove the end covers at the entrance and exit end of the machine to expose the frame ends and the belt shaft bearing mounts at the end of the belt shafts. The following procedure can be used to correct tracking problems at either end of the furnace.</p> <p>Loosen the belt shaft bearing mount bolts at one end of the furnace (entrance or exit). While facing the end (entrance or exit) of the furnace, use the following procedure. If the belt is tracking to your left, pull the left side of the belt shaft forward and/or move the right side of the belt shaft rearward. If the belt is tracking to your right, pull the right side of the belt shaft forward and/or move the left side of the belt shaft rearward. Repeat this procedure at the other end of the furnace. It is best to make these adjustments in small increments. Adjustments that are too large will cause a belt tracking problem in the other direction. Now run the belt at its highest speed and observe how the belt is tracking. Repeat the adjustment procedure until the belt tracking is centered.</p>	<p>Visually verify tracking - Weekly</p>	
	<p>Chamber</p>	<p>The chamber normally does not require maintenance. If a problem with the chamber is suspected, contact the manufacturer. Because the process gas is inserted through the insulation, the gas flow through the insulation generally prevents contamination from accumulating on the chamber walls. To reduce flux or other residue accumulated in the chamber, the zones can be set at 400°C to place the furnace into a self-cleaning cycle for about an hour to burn out organic residues.</p>	<p>Process dependent</p>
<p>Cooling Fans</p>	<p>Inspect all system cooling fans for freedom of movement and proper operation.</p>	<p>1 year</p>	
<p>Drip Trays</p>	<p>Remove and clean the drip tray, located under the process exhaust stack. Access to the tray is through the top removable section of the furnace chamber, located above the tray at the furnace entrance. Depending on the process, if very little buildup is found, cleaning may not be necessary more than once a year.</p>	<p>After the first 6 months of operation; as required thereafter.</p>	
<p>Drive Chain</p>	<p>The chain drive system is contained in the motor enclosure at the exit end of the oven. Lubricate the drive chain with FurnacePros #100523 chain lube or a commercial quality non-dripping chain lube.</p>		<p>Every 1 year of operation</p>

Table 7-1 Recommended Maintenance & Frequency

Equipment	Recommended Maintenance	Recommended Interval
Drive Chain Tensioner	The chain tensioner is equipped with a grease fitting for lubrication. The chain tensioner should be lubricated every 6 months with general multipurpose bearing grease. Apply enough grease to the tensioner until excess grease can be seen squirting out along the shaft of the device. Wipe off all excess grease to avoid dirt accumulation.	6 months
Drive Motor Mounts	The drive motor is contained in the enclosure at the exit end of the oven. The motor mount bolts must be checked periodically and tightened if necessary.	Annually, or as required.
Exhaust Stack	A visual inspection of the stack is recommended along with each drip tray cleaning. With a flashlight, look down the furnace stack. Check the exhaust stacks, after 6 months of operation, for possible buildup of materials generated from firing processes. The stacks should be cleaned, as necessary, with a brush and solvent to remove the buildup. A periodic inspection of the stacks is essential to establish a sensible maintenance cycle, since some processes will require frequent cleaning, and others require none at all. Contact LCI/FurnacePros if new gasket material is required to reattach the stack.	After the first 6 months, and thereafter as required.
Lamp Heating Elements	No maintenance is required for the heating elements other than replacement when one fails. Note that with low temperature operations, the lifetime of the heating element is in excess of 100,000 hours. At temperatures increase above 260C, the life of the lamps declines over time. Should failure occur, it will be sudden. When lamps are firing, the EM Top/Bottom Lamp String LED's on the control console will immediately reveal any lamp string with a failure. Use ohmmeter for best results (section 7.6.5), visual inspection is unreliable. Refer to section 7.8.10 for instructions for changing heating elements. Operating with sufficient process gas to the lamp seals (plenums) will greatly increase lamp life.	Inspect regularly; replace lamps as required.
Lamp Seals	Inspect the lamp seals (Kaowool packing around the ends of the infrared lamps) for loose, cracked or missing packing material. Once the side covers are removed, the lamp seals can be visually inspected. Inspect after first 6 months of operation. 	<500C operation, every 2-3 years; >500C operation, annually.
PLC Low Battery ERR	The PLC can operate without its battery. The battery is only used to retain belt speed values during shutdown. When the PLC battery is <2.5 Vdc, ERR red light on the PLC CPU module will blink to alert for this condition. If the battery is low, the belt speed value will not be retained in PLC memory. Replace battery in top of CPU with 3V coin battery CR2354. See section 7.8.7 Replacing PLC Battery.	Every 5 years or as indicated.

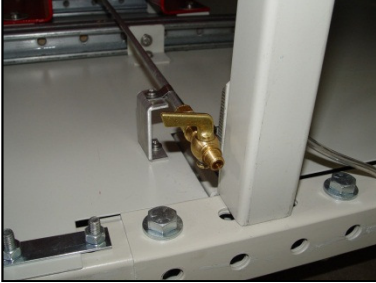
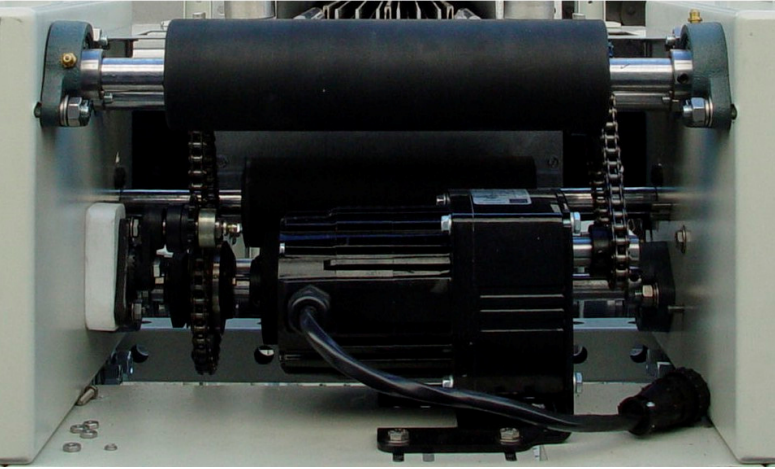
Table 7-1 Recommended Maintenance & Frequency		
Equipment	Recommended Maintenance	Recommended Interval
Sprocket Alignment	The sprockets are contained in the motor enclosure at the exit end of the oven. Visually verify that the sprockets are aligned. Adjust according to the furnace Reference Manual, Chapter 7.	After first 30 days and annually thereafter.
Sprocket Shaft Bearing Block	The sprockets are contained in the motor enclosure at the exit end of the oven. The sprocket shaft bearing block is equipped with a grease fitting for lubrication. The bearing block should be lubricated with general multipurpose bearing grease. Apply enough grease to the bearing block until excess grease can be seen squirting out along the shaft of the device. Wipe off all excess grease that has squirted out to avoid dirt accumulation.	After first 6 months; annually thereafter.
Transport Belt Length	Check the length of the transport belt and shorten it if the gravity loop comes within 6 inches of the floor. A properly shortened belt should hang between 2 and 3 inches below the main frame.	Annually, or as required.
Transport Clutch	The clutch should be inspected periodically to insure proper tension on the belt. To adjust, tighten the large hex nut at the chain sprocket end of the drive drum until the drum turns. If the drum cannot be stopped by firm pressure with your hands, the clutch is too tight. Do not over tighten the clutch, as it is there for safety reasons.	Annually, or as required

7.6 Troubleshooting

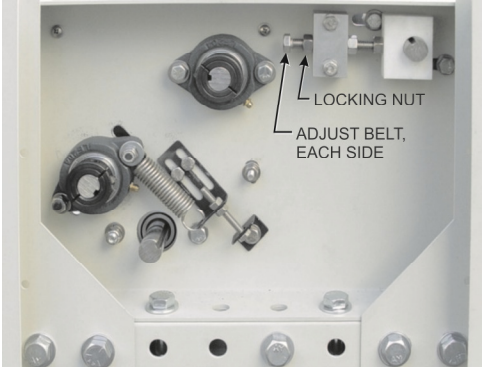
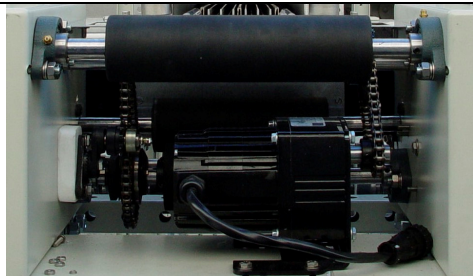
To troubleshoot, follow all suggested remedies sequentially to determine source of the problem.

7.6.1 Transport System - Jerking or Vibrating of the Belt

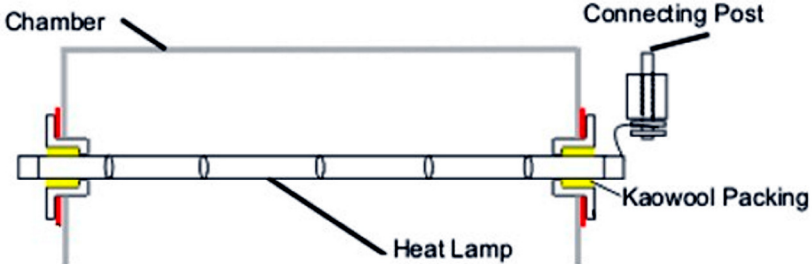
Items to check include:

- a) Make sure the belt is not overloaded with heavy product.
- b) Verify belt tensioning weight is free to move.
- c) Verify belt is free to move without obstruction from product or objects penetrating belt.
- d) Adjust belt tracking (see section 7.8.5).

See Table 7-1 Recommended Maintenance and Frequency for information on other items which may be the root cause of a jerking belt including maintenance and adjustment of Belt shaft rollers, Belt Tracking Adjustment, Drive Chain, and Drive Chain Tensioner.

7.6.2 Troubleshooting Power Issues

Note that remedial steps marked “*” require access to the controls enclosure and should be performed only by qualified maintenance personnel. Remember to pull out the controls enclosure interlock switch to the “maintenance” position to supply power to the enclosure with the access panel open.

Table 7-2 Troubleshooting Power		
Symptom	Cause	Remedy
MAIN POWER lamp is OFF. All controls and displays are OFF.	Power is OFF to furnace.	<ol style="list-style-type: none"> 1. Turn power back on at the circuit breaker. 2. Check EMOs (twist CW to reset) and Interlock switches: pull out to Maintenance position or make sure side panels are in place on both sides of the furnace section and on the control enclosure rear access panel. 3. Check TR0 transformer line fuses F1 and F2. Refer to Drawing 802-101779 Safety Panel Schematic for details*.
MAIN POWER lamp is OFF. All controls and displays are ON.	MAIN POWER lamp is burned out.	<ol style="list-style-type: none"> 1. Replace MAIN POWER lamp.
MAIN POWER lamp is ON. CONTROLS indicator is OFF. All controls and displays are OFF.	Power is OFF to the CONTROLS circuit.	<ol style="list-style-type: none"> 1. Push green CONTROLS button to turn CONTROLS ON. 2. If this does not turn controls and displays ON, check 24 Vac supply fuse FA (5A, AGC). Refer to Drawing 802-101780 Power Control Schematic for details*. 3. Check operation of K2 relay*: If no green indicator light visible, press red button on relay. If the relay does not switch, replace relay. 4. Check that PLC is on*: If PLC is all dark and 24 Vdc power supply (immediately to the left of the PLC) green light is dark, check power supply fuse FJ (2A, AGC).
MAIN POWER lamp is ON. CONTROLS indicator is OFF. All controls and displays are ON.	CONTROLS lamp is burned out.	<ol style="list-style-type: none"> 1. Replace CONTROLS lamp*.
MAIN POWER lamp is ON. CONTROLS indicator is ON. All controls and displays are OFF. All controllers, the belt speed display, the PLC, the fans and the belt are OFF.	Power is OFF to 117 Vac supply.	<ol style="list-style-type: none"> 1. Check fuse FB (4A, AGC)*. 2. Check operation of K6 relay*. If no green indicator light visible, press red button on relay. If the relay does not switch, replace relay.

Table 7-2 Troubleshooting Power		
Symptom	Cause	Remedy
<p>MAIN POWER lamp is ON. CONTROLS indicator is ON.</p> <p>All controls are ON.</p> <p>The fans and the belt are ON.</p> <p>A controller or the belt speed display is OFF.</p>	<p>117 Vac fuse blown.</p>	<p>1. Check following fuses*:</p> <p>FE – Zone 1 Controller (1A, AGC)</p> <p>FF – Zone 2 Controller (1A, AGC)</p> <p>FG – Zone 3 Controller (1A, AGC)</p> <p>FH – Belt Speed Display (new furnace: 1A, AGC; rebuilt RTC furnace: 0.5A, AGC).</p> <p>Refer to Drawing 802-101781 Frame Wiring Schematic for details.</p>
<p>MAIN POWER lamp is ON. CONTROLS indicator is ON.</p> <p>Zone controllers, the belt speed display and the fans are ON.</p> <p>The belt is not moving.</p>	<p>Rotate BELT SPEED knob CW to speed up belt. If the belt still does not move, it is likely that a fuse is blown on the motor speed controller.</p>	<p>1. Turn power off to the furnace at the circuit breaker. Check both the line fuse and motor fuse on the motor speed controller. Refer to Drawing 802-101781 Frame Wiring Schematic for details*.</p>
<p>MAIN POWER lamp is ON. CONTROLS indicator is ON.</p> <p>All controls and displays are ON. The fans and the belt are ON.</p> <p>LAMPS indicator is ON.</p> <p>LAMP STRINGS indicators are OFF and zone controller PV temperatures are falling or not changing.</p> <p><u>Note:</u> In normal operation at lower setpoint temperatures, the LAMP STRINGS indicators will turn OFF whenever lamp power maintaining zone temperature falls below the threshold of the LAMP STRINGS current sensors. In that case, the reduced power to the lamps is still sufficient to keep zone controller PV temperatures at setpoint SV temperatures.</p>	<p>No power to the lamps.</p>	<p>1. Confirm there is no OVERTEMPERATURE Alarm active, preventing lamps from turning ON – refer to section 4.2.3 for details. Press CLEAR pushbutton on the ALARM panel to clear such an Alarm.</p> <p>2. Confirm that desired zone switches are in ON position on the ENERGIZE LAMPS panel.</p> <p>3. Confirm that zone controller setpoint temperatures have been set (SV display is bright and steady).</p> <p>4. Confirm that zone controller OUT1 LED indicators are ON.</p> <p>5a. Cycle LAMPS red and green pushbuttons OFF and ON. You should easily hear the “snap” of the K1 lamp contactor opening and closing.</p> <p>5b. If the K1 “snap” is not heard, check operation of the NO1 terminal on the PLC CO-04TRS module (4th module to the right of the PLC power supply). Cycling the LAMPS pushbutton (see 5a above) should cycle the NO1 red LED on/off. If the NO1 red LED turns on and the K1 contactor does not, the contactor or its coil is bad and must be replaced*.</p> <p>6. Check lamp fuses F30, F31, F32, F33, F34 and F35*.</p>

7.6.3 Troubleshooting Temperature Control

Table 7-3 Temperature Control Troubleshooting		
Symptom	Cause	Remedy
A PV zone temperature is always higher than its SV setpoint temperature.	Turn zone switches for the affected zone OFF. If the PV temperature remains high or is increasing, heat is being added to the zone from <u>outside</u> the zone.	<ol style="list-style-type: none"> 1. Increase gas flow into zone. 2. Change direction of gas flow. 3. Change setpoint to hold higher temperature. 4. Change setpoint of adjacent zone(s). 5. See section 7.6.2 for more information.
A PV zone temperature is unstable, with temperature varying up and down several degrees.		<ol style="list-style-type: none"> 1. See sections 7.6.2 and 7.6.3 for more information. 2. Auto Tune the zone. See section 7.6.4 for more information.
Zone heat increasing rapidly toward an over-temperature condition and cannot be stopped	SCR output shorted	<ol style="list-style-type: none"> 1. Replace the SCR*. See section 7.7.1 for more information. 2. Contact the LCI factory for properly configured replacement SCR controller.

7.6.4 Element Failure Indication (EM)

The element monitor LEDs on the Test panel indicate an open heating circuit or failed lamp heating elements. An LED turns ON when current is flowing through its respective lamp string. A lamp string is one or more lamps connected in series.

Press the CALIBRATE button to energize the lamps in the zones that are switched ON. LEDs that fail to light in an energized zone indicate a failed lamp sting. See **Table 7-4 Zones, Lamp Strings and Lamps** to identify which strings should be ON when a zone is switched ON and the CALIBRATE button is pressed.

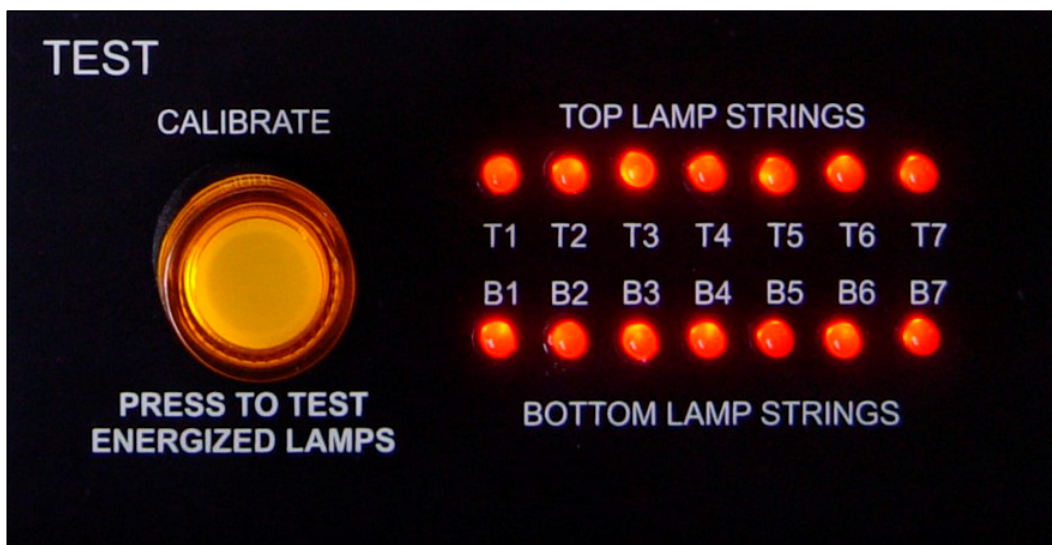

Figure 7-17 Test Panel: Lamp String Failure Indicator

If a lamp string LED does not light when operating, follow the procedure in Section 7.6.5 **Heating Element Test Procedure** to isolate the failed lamp.

Note: During normal operation at very low current levels, the LED lamps may not light.

7.6.5 Heating Element Test Procedure

To simplify troubleshooting, the TOP LAMP STRINGS and BOTTOM LAMP STRINGS LED arrays display the specific location of a suspected failed lamp string during operation. For a more reliable check, the user should perform the Testing Lamps process in section 4.5.

Visual inspection of the lamps (either by looking down the entrance of the furnace or by removing the lamp covers) with the power on or off is not reliable. When adjacent lamps are on, reflected light will make a defective element appear okay. If the Testing Lamps process confirms that a string has failed, note the LAMP STRINGS indicator (T1, B1, etc.) that was OFF during the test, and use the following procedure to isolate which lamp in that identified string has failed.

This procedure is to be used to test for open heating or failed lamp heating elements.

A. Required Equipment

1. Ohmmeter (or Continuity Tester)
2. 3/8" Box or Open End Wrench
3. Control & Element Wiring Schematic 802-101814

B. Test Procedure

Remove all power from the furnace, and if a UPS or EPS is installed, locate and shut off the unit. Remove all side covers, completely exposing all lamp terminations.

Locate the identified failed string and the lamps in that string using this table:

Table 7-4 Zones, Lamp Strings and Lamps			
Standard Power LA-306		High Power LA-306	
TOP LAMP STRINGS	Lamps	TOP LAMP STRINGS	Lamps
T1 – Zone 1	E1, E2	T1 – Zone 1	E1, E2
T2 – Zone 1	E3, E4	T2 – Zone 1	E3, E4
T3 – Zone 2	E1, E2, E3	T3 – Zone 2	E1, E2
T4 – Zone 2	E4, E5, E6	T4 – Zone 2	E3, E4
T5 – Zone 3	E1, E2	T5 – Zone 2	E5, E6
T6 – Zone 3	E3, E4	T6 – Zone 3	E1, E2
		T7 – Zone 3	E3, E4
Standard Power LA-306		High Power LA-306	
BOTTOM LAMP STRINGS	Lamps	BOTTOM LAMP STRINGS	Lamps
B1 – Zone 1	E1, E2	B1 – Zone 1	E1, E2
B2 – Zone 1	E3, E4	B2 – Zone 1	E3, E4
B3 – Zone 2	E1, E2, E3	B3 – Zone 2	E1, E2
B4 – Zone 2	E4, E5, E6	B4 – Zone 2	E3, E4
B5 – Zone 3	E1, E2	B5 – Zone 2	E5, E6
B6 – Zone 3	E3, E4	B6 – Zone 3	E1, E2
		B7 – Zone 3	E3, E4

Within each zone, lamp E1 is nearest the entrance end of the furnace.

Disconnect one end of each of the 2 or 3 lamps in the suspect string and measure the resistance of each lamp. The resistance of a good lamp is <10 Ω. A higher reading identifies a defective lamp that should be replaced.

Refer to section 7.8.10 Infrared Heat Lamp Replacement for lamp replacement instructions.

Once the elements have been completely tested, replace the covers on the furnace. Turn on the EPS/UPS (if so equipped) and power to the furnace. Bring the furnace up to temperature, and, next, run a profile verifying that no leaks occurred around the lamps that were replaced.

The procedure is now complete.

7.7 Troubleshooting Process Problems

7.7.1 Belt speed

Measure the belt speed with a stopwatch (see 7.9.2). If it differs from the value on the process screen by more than 5% (1 IPM off for each 20 IPM of belt speed), re-calibrate the belt speed. Follow the Belt Speed Calibration procedure in section 7.9.3.

SPEED ADJUST: Belt speed may be changed at any time whether the lamps are ON or OFF. However, for best practice:

1. Before lamps are turned ON, set the control system to Manual by pressing CALIBRATE button for 5 seconds,
2. Adjust SPEED ADJUST knob until proper belt speed is displayed.
3. Display will fluctuate, press CLEAR button immediately when desired speed is displayed to lock in the value.

Figure 7-18 Tips on Adjusting Belt Speed

7.7.2 Belt speed memory

The PLC normally stores the values for the belt speed so that if the furnace can return to its previous speed upon restart. If the PLC fails to retain the speed value, open the top of the control enclosure. If the red ERR light on the CPU is blinking, replace battery. See section 7.8.7 Replacing PLC Battery.

The furnace can operate without a PLC battery. The battery is only used to retain belt speed values during shutdown. When the PLC battery is below 2.5 Vdc, the red ERR light on the PLC CPU module will blink to alert for this condition. If the battery is low, the belt speed value will not be retained in PLC memory.

7.7.3 Resolving zone control issues

Zone switches are useful for use in troubleshooting and resolving zone control issues, testing lamps (see section 4-9) and checking for blown lamp fuses (see Table 7-2 Troubleshooting Power).

Zone Control. If heat in any zone increases rapidly into a “runaway” condition even if the zone controller OUT1 LED indicator is dark (the controller output is OFF), but the heat can be stopped by shutting off the affected zone top and bottom switches, the zone SCR probably has failed with a shorted output and needs to be replaced.

If the heat in any zone steadily stays above the SV, but is not in a “runaway” condition, shut off the affected zone top and bottom switches and see if the heat decreases. If it does not, the furnace has a process gas flow problem or the SV in adjacent zones may need to be lowered.

Types of Energy. The ability to turn banks of lamps off and on via the zone switches on the ENERGIZE LAMPS panel allows the user great flexibility in applying energy to each zone. Use just the top lamps in each zone for drying moisture or volatile organic compounds from the top surface of substrates or trays, or curing thermosetting compounds or coatings on wafers or polycarbonate materials. Use both top and bottom lamps in traditional furnace applications. Use just the bottom lamps to emphasize conduction heating of parts from the transport belt and from IR radiation on the bottom of metallic or ceramic parts carriers.

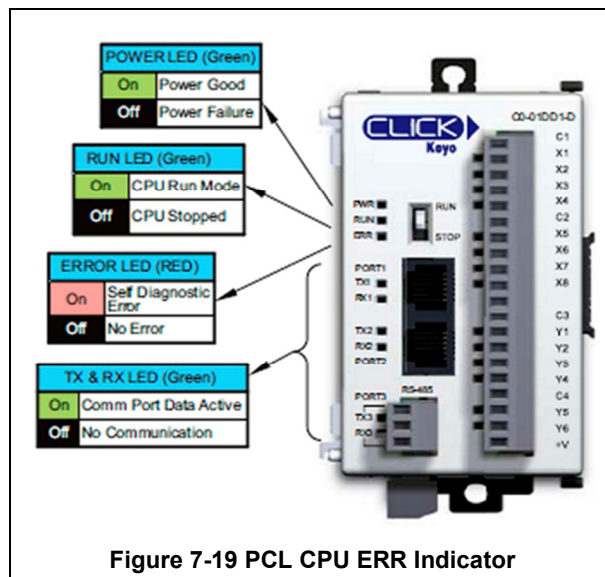

Figure 7-19 PCL CPU ERR Indicator

7.7.4 Temperature or large power fluctuations

If the temperature is slow to respond to large deviations from setpoint temperature, it may be a problem with the PID settings. If you need to modify a particular zone, see the procedures in section **5.2 Controller PID Tuning**.

At low temperatures (<100°C) or near the maximum temperature, if there is an unacceptable deviation from setpoint, the SCR may need to be calibrated. If the SCR is out of calibration, most likely it will not be noticeable in the medium range of the temperature. If necessary, calibrate the SCR's using the procedure in section 7.9.1.

NOTE: PID tuning should only be attempted by qualified personnel. Unreasonable PID parameters can stress the components of the system and cause premature failure of some electrical systems.

7.7.5 Unstable zone temperatures

If the temperature fluctuates by more than 5 degrees in less than 20 seconds after you reached ready state, it might be a problem with the PID settings. If you notice unstable behavior in a certain zone, you may need to modify the PID loop parameters for that particular zone. Follow the procedures in section **5.2 Controller PID Tuning** to retune the PID loop parameters.

NOTE: PID tuning should only be attempted by qualified personnel. Unreasonable PID parameters can stress the components of the system and cause premature failure of some electrical systems.

7.7.6 Abnormal sensor behavior

There are numerous sensors (standard and optional) on the furnace, from thermocouples to an optional gas analyzer, and so on. If one particular sensor seems to behave erratically, you will need to look into the value reported by the control system and recalibrate or replace as necessary.

The errors could be

- a temperature with an erroneous or negative value,
- a gas analyzer display that never changes value.

7.8 Service

7.8.1 Damaged Belt Options

If a section of the belt is damaged you can:

- A. Straighten the wires in the section, or
- B. Replace the section with a belt splice, or
- C. Replace the belt.

7.8.2 Straightening the Belt

If the damage is not too severe the belt often can be straightened.

1. Move the damaged section to the entrance load or exit unload area.
2. Using a pair of long nose pliers gently bend the distorted wires to match the pattern of the undamaged portion of the belt.
3. Use a straight edge to verify that any dips in the damaged section have been removed.
4. Turn on the compressed gas supply to tension the belt. Start the furnace and operate the belt without heat to verify alignment.

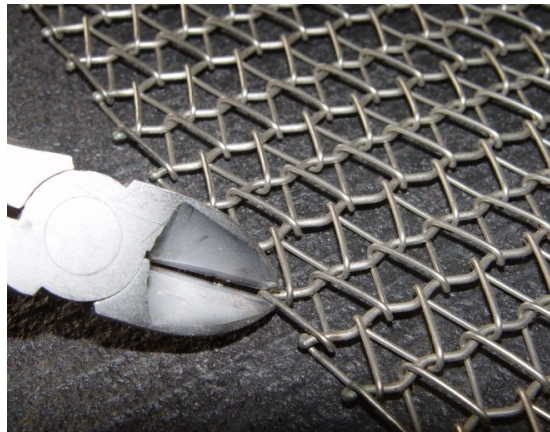

Figure 7-20 Cut Wire at Ball Joint

7.8.3 Replacing a Belt Section

If a section of the belt becomes damaged, but the rest of the belt is in good condition, a new section of belt can be installed.

Contact FurnacePros to order a replacement belt that will meet your needs.

A. Determine the Portion of Belt to be Replaced

1. Mark off the section to be removed with a masking tape or permanent marking pen on either end of the damaged area of the belt. Note: compressed gas supply to furnace should be off.
2. Remove the weight tensioning bar from the holder. Lift the weight bar out to relieve the belt.
3. Take all the slack out of the belt by grasping the belt on either side of its width and pulling evenly and firmly.
4. The damaged belt section should then be located at the entrance Load or exit Unload area so you can work on the belt and splice it easily.



Figure 7-21 Second Cut at Opposite Side

B. Removal of the Bad Section of Belt

1. Cut one of the cross-section wires travelling the width of the belt at the front of the damaged section. Make cut at ball joint on either side of the belt (see Figure 7-20 and Figure 7-21).
2. Remove the wire by pulling straight through the belt (Figure 7-22) and retain for later splicing.
3. Remove a second cross-section wire on the other end of the damaged section in the same manner.
4. Measure the length of the section removed. Prepare a new section of belt the same size by removing one of the cross-section wires.

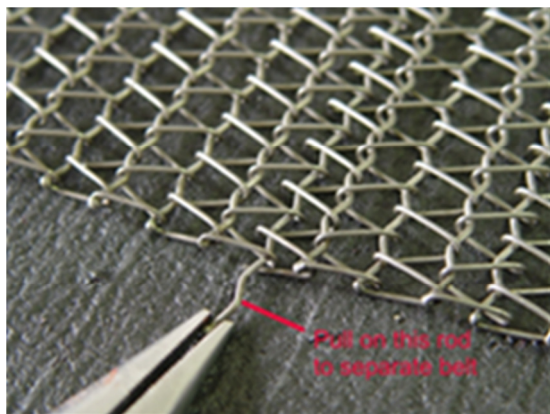

Figure 7-22 Remove belt wire

C. Install new section of the Transport Belt

1. Place the new belt section parallel and slightly overlapping the edge of the remaining belt on the furnace. Make sure to orient the belt as shown in Figure 7-23.
2. Splice as shown in Figure 7-23 and Figure 7-26 by inserting one of the cross-section wires through the belt mesh across the width of the belt. Insert a second wire at the other end of the splice to the rest of the belt.
3. Both wires should be even and parallel and aligned with the belt edges. The cross-section wires will stay in place without any finishing at either end.
4. Reinsert belt weight as shown in Figure 7-28. If necessary, pull belt to the left or right to align Belt so that Belt Weight is allowed to move freely as shown in Figure 7-28.
5. Turn on the compressed gas supply to tension the belt. Start the furnace and operate the belt without heat to verify alignment.

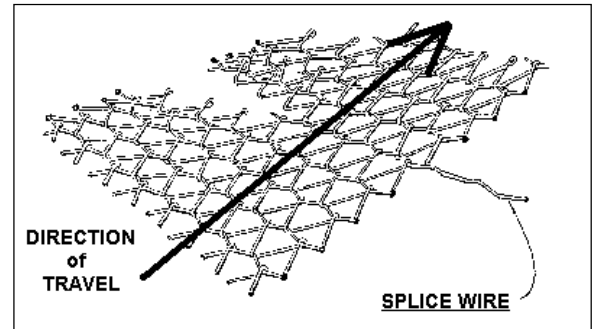

Figure 7-23 Belt Splice

7.8.4 Transport Belt Replacement

If the belt becomes damaged or too worn or dirty for continued satisfactory performance a new belt can be installed. Contact FurnacePros to order a replacement belt that will meet your needs.

A. Removal of the Transport Belt

1. At the entrance of the furnace, cut one of the cross-section wires travelling the width of the belt. Make cut at ball joint on either side of the belt (see Figure 7-20 and Figure 7-21).
2. Remove the wire by pulling straight through the belt (Figure 7-22) and retain for later splicing.

B. Installation of the Transport Belt

When installing the belt, have an assistant ready to help guide the belt into the furnace entrance.

1. Position the new belt at the furnace entrance. Orient belt as shown in Figure 7-24.
2. Attach the leading of the new belt to the end of the old belt (see Figure 7-25).
3. From the exit, carefully pull the belt through the furnace from the exit end, while an assistant at the entrance unrolls and guides the belt into the furnace

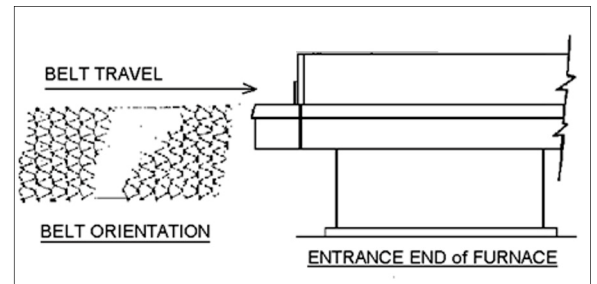

Figure 7-24 Belt Orientation

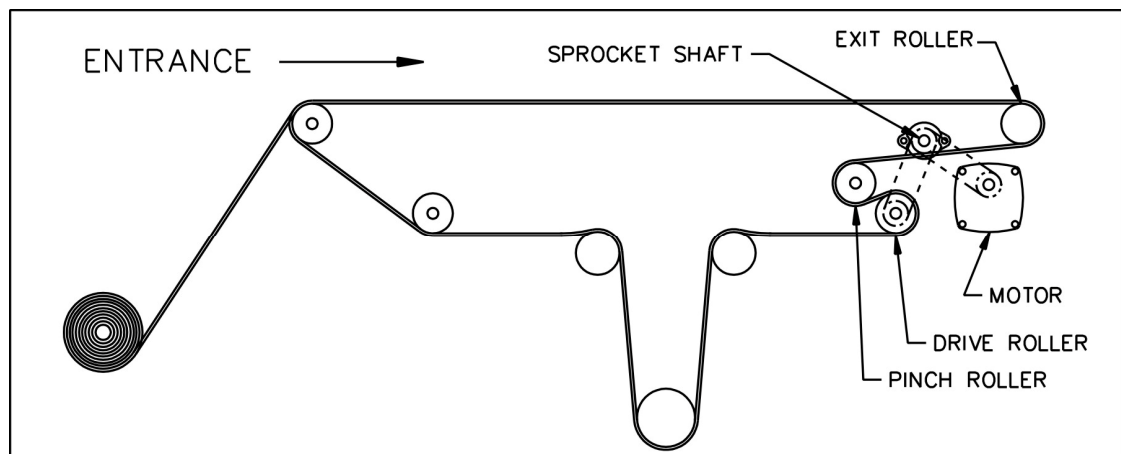

Figure 7-25 Belt Path

4. When the belt has been pulled through the furnace chamber, detach it from the old belt and thread a pull wire through the rollers and drive drum, as shown in Figure 7-25 Belt Path. Pull the leading edge of the belt to the entrance and splice.

C. Splicing the Belt

1. Line up the ends of the belt so they are parallel and slightly overlapping.
2. Splice the belt by inserting one of the cross-section wires through the belt mesh across the width of the belt as shown in Figure 7-26 and Figure 7-27 .
3. The wire should be even and parallel and aligned with the belt edges. The cross-section wire will stay in place without any finishing at either end.

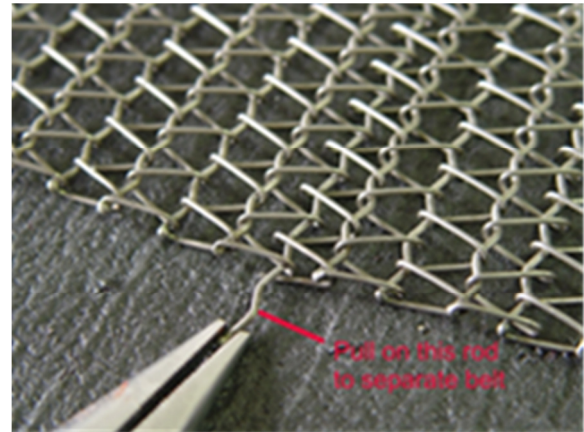

Figure 7-26 Insert Splice Wire

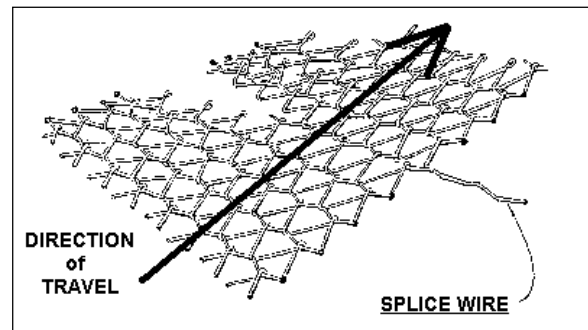

Figure 7-27 Belt Splice

D. Install Belt Weight

Reinsert belt weight as shown in Figure 7-28. If necessary, pull belt to the left or right to align Belt so that Belt Weight is allowed to move freely as shown in Figure 7-28.



Figure 7-28 Belt Weight in Place

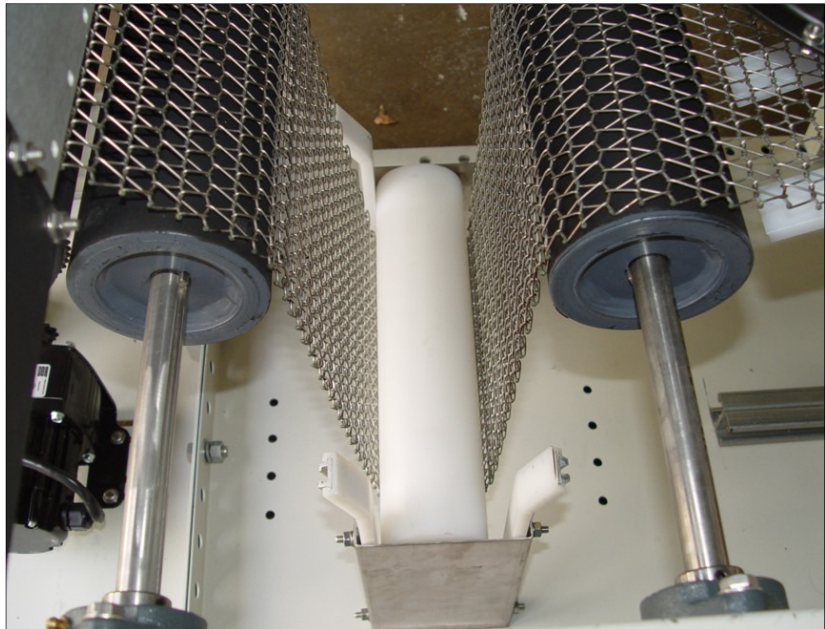

Figure 7-29 Proper Alignment of Belt Weight

7.8.5 Drive Train / Belt Alignment

A. Sprocket Alignment

Unscrew the end cover at the exit end of the furnace to reveal the motor and drive mechanism. All sprockets should be perfectly aligned. Adjustments can be made by loosening the setscrews on the sprocket flanges. A straight edge can be useful for this operation.

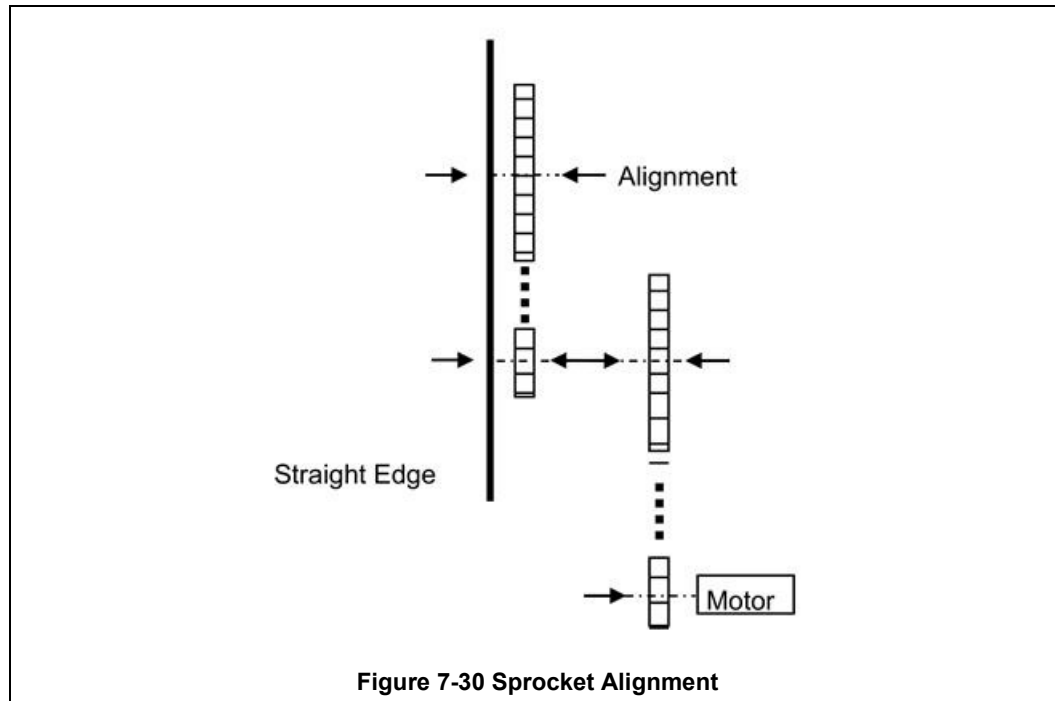

Figure 7-30 Sprocket Alignment

B. Motor Mount Bolts

Motor mount bolts must be checked periodically and tightened if necessary.

C. Sprocket Shaft Bearing Block Bolts

These shafts must be checked periodically. You will need to remove the end side covers to gain access to the bolts.

Sprocket shaft and roller shaft bearings are sealed units requiring no maintenance. The greasing points are redundant.

D. Chain Tension and Drive Chains

The chain tensioner is equipped with a grease fitting for lubrication. Apply sufficient grease to the tensioner so that grease can be seen squirting out along the shaft. Remove excess grease.

If the tensioner is spring loaded, no adjustment is necessary. For other types of tensioners, slacken the mounting bolts and turn the tensioner towards the chain. Tighten the bolts. A correctly tensioned chain can just be lifted from the tensioner sprocket, but cannot be lifted clear of the sprocket teeth.

Drive chains should be lubricated with a non-dripping chain lubricant every 30 days.

E. Belt Roller Alignment

If a roller is misaligned on its shaft, loosen the setscrews that secure the roller on its shaft. Use a rubber mallet to move the roller. Rollers need to be centered within 0.125 inches so you will need a ruler or scale for this operation.

F. Clutch Adjustment

With the motor running, the belt should be stoppable by placing firm pressure on the entrance roller. If the belt can be stopped too easily, tighten the clutch nut. If it cannot be stopped at all, slacken the clutch nut.

G. Belt Tracking

To check belt tracking:

1. Turn Furnace Lamps OFF
2. Adjust belt speed to maximum
3. Stand at the furnace exit or entrance and look along the length of the belt.
 - If the belt appears to be running toward one side, pull the belt to the center.
 - If the belt still appears to be running toward one side, you will need to adjust the tracking.

To adjust belt tracking:

1. Belt tracking is adjusted at any or all of 4 points at both ends and both sides of the Furnace as shown in Figure 7-31 Belt Tracking Adjustment Diagram.
2. Remove covers at entrance and exit ends of the furnace.
3. Observe belt travel and determine required adjustments to move Belt Shaft Drive Roller more perpendicular to the belt path.
4. Follow maintenance instructions in Table 7-1 under Belt Tracking Adjustment to make actual adjustments

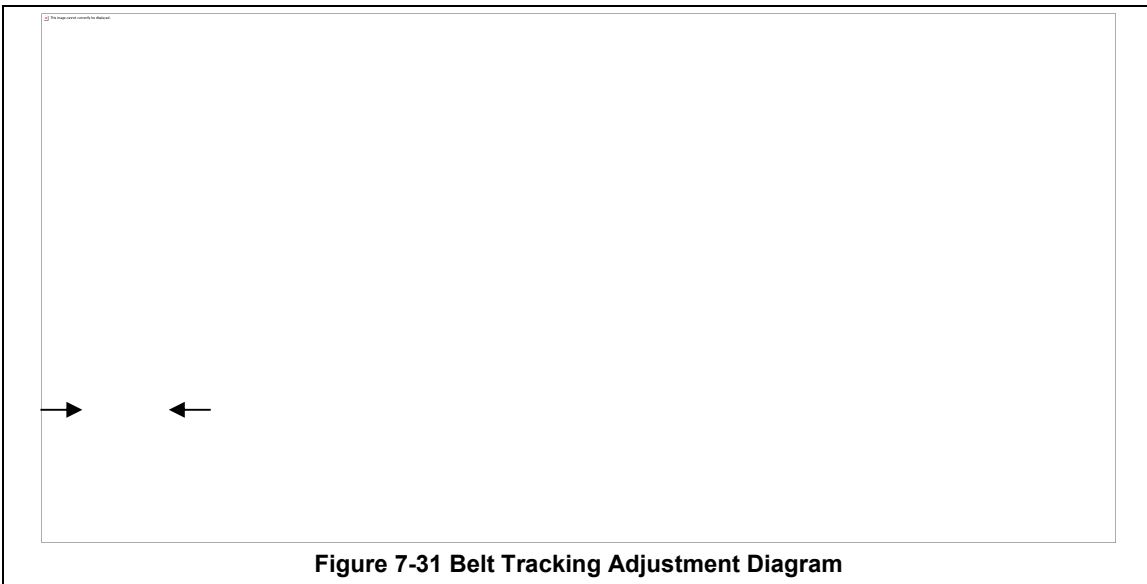

7.8.6 Drip Tray Cleaning

Drip trays are located in the furnace entrance baffle and transition tunnel baffle sections. Drip trays may collect condensate if the exit gas is not cool enough to keep the exhaust in a gaseous state.

The maintenance and period for drip trays depends very much on the processes being run. You may only have to use a vacuum to remove debris from the drip tray instead of removing the whole assembly. While some processes require drip trays to be cleaned every month, others processes may barely soil the drip trays.

A. Drip Tray Removal

1. Unscrew and remove the furnace side covers. If necessary, remove the cooling fan assembly.
2. Disconnect the T-pieces that connect the gas supply to the air-rake tubes. The T-pieces must be disconnected at the top and bottom but the connection to the air-rake tube may remain connected.
3. Undo the air-rake retaining nut.
4. Completely remove the air-rake tubes.
5. Undo the butterfly nuts holding the drip-tray inspection cover in place and remove the inspection cover.
6. Remove the drip tray being careful not to damage the attached baffle plates.

B. Clean Drip Tray

1. Wash or mechanically clean drip tray parts.

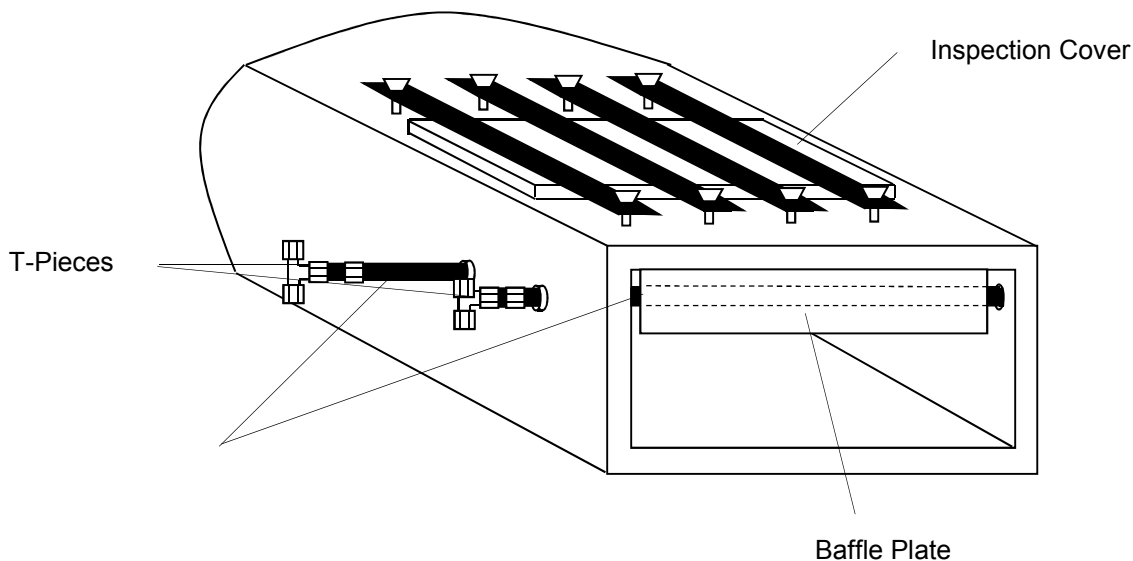

Figure 7-32 Drip Tray Cleaning Diagram

C. Drip Tray Installation

Re-installing the drip tray is easier if the baffle plates are tied flat against the drip tray. This is easily achieved by loosely wrapping a piece of wire around the drip tray and baffle plates.

1. Insert the drip tray and baffle assembly. Remove the wire.
2. Replace the inspection cover and reattach clamps. After several hours of operation, check the butterfly nuts on the inspection cover, and tighten if necessary.
3. Reinstall air rakes making sure that they are oriented as before with the notch on the alignment ring facing up.

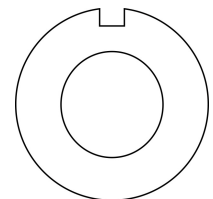

Figure 7-33 Air Rake Alignment Ring

7.8.7 Replacing PLC Battery

A. Battery Installation

If the ERR light is blinking, follow the instructions below to replace the battery in the PLC with a 3V lithium CR2354 coin battery.

Installing a new battery in an LCI furnace control system PLC

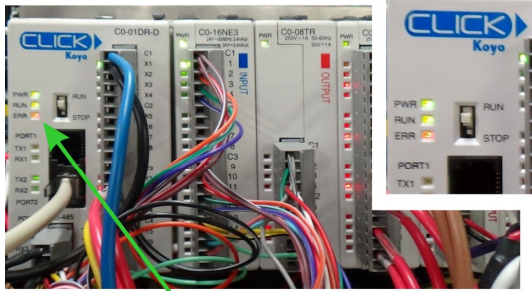

1. Replace battery when ERR light is red.



4. Open battery compartment and insert battery. Battery can only be installed one way.

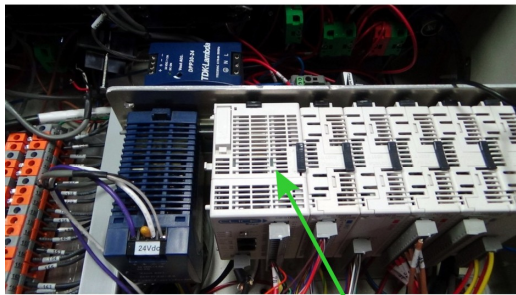

2. Locate top of PLC CPU module.

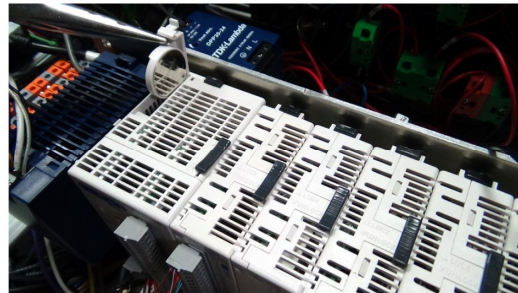

5. Battery properly installed.

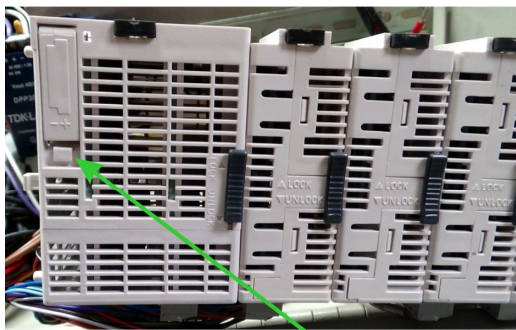

3. Locate battery compartment. Lift tab to open.

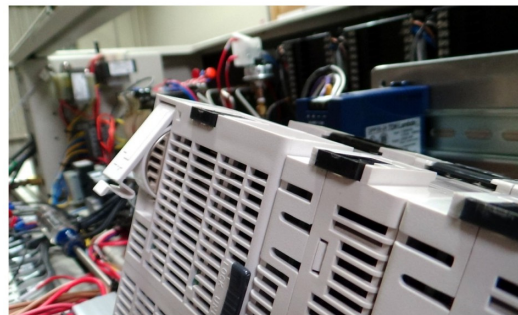

6. Rotate compartment and press gently to close and latch.

Figure 7-34 Replacing the PLC Battery

7.8.8 Replacing SCR Control Modules

A. SCR REMOVAL

To remove the entire SCR assembly, disconnect the 10Vdc and the 24 Vac wire pairs. Unscrew the Line and Load wires. If you are only replacing the firing board, remove the (2) firing board screws. If you are removing the entire assembly, remove the (2) SCR Mounting screws. See **Figure 7-39 Speed Adjust Tips**

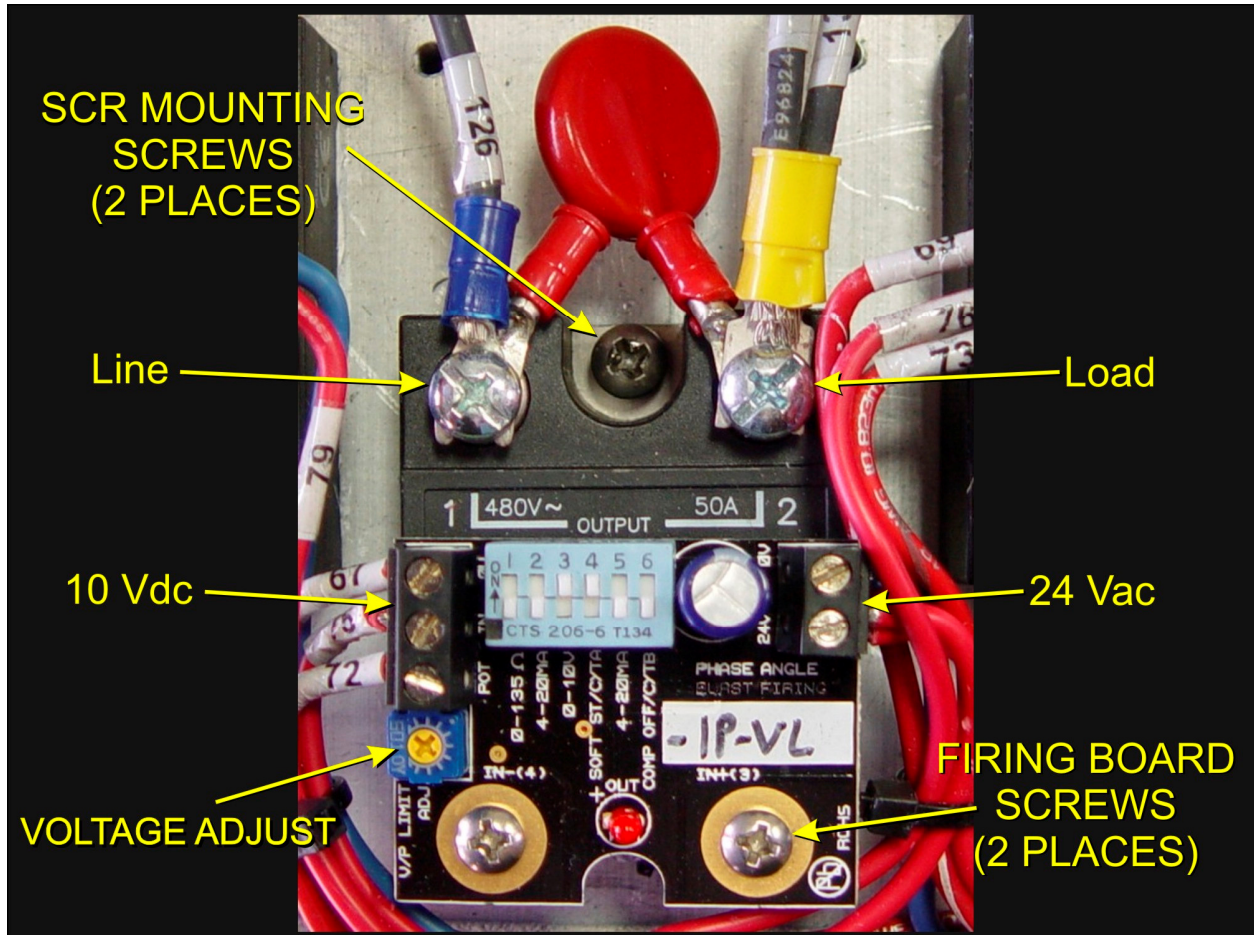

B. SCR INSTALLATION

Install an entire SCR assembly, by first checking that thermal paste is applied to the back of the SCR and the heat sink (aluminum plate) in the location where it will be mounted. Screw the assembly to the heat sink. Connect the 10 Vdc control wires, the 24 Vac control voltage wires and the Line and Load wires with red capacitor in place. Make sure the dip switch is set as shown in Figure 7-39. Then follow the procedure on page 7-28, section 7.9.1 **Calibrate SCRs** to calibrate the SCR.

7.8.9 Replacing Console Indicator Lamps

Alarm LED's are pressed into the face of the control console. They can be removed by disconnecting the two leads and pushing from the inside. Alarm indicator lamps are 24Vdc LEDs and must be installed with the proper polarity to avoid damage to the LED.

The lamp indicator LEDs are inserted through the panel from the backside (see Figure 7-36 Lamp in Panel). To remove them from the control console, remove the LED rear retaining ring and press from the front of the Control Console. These parts are integral with the black current indicator. The whole single LED assembly should be replaced if damaged (see Figure 7-35 Lamp Indicator Installation).

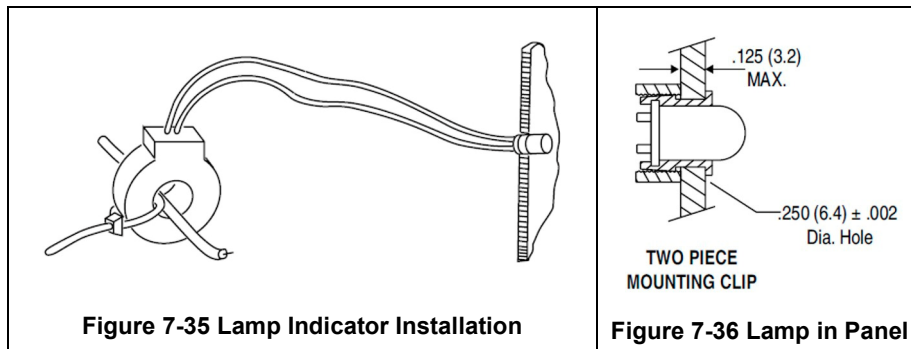

Figure 7-35 Lamp Indicator Installation

Figure 7-36 Lamp in Panel

7.8.10 Infrared Heat Lamp Replacement

A. Tools Required:

(2) 3/8 in. open ended wrenches	Replacement Kaowool packing material
Allen wrench	Lint free cloth or protective gloves
Flashlight	

B. Handling Heating Lamps

Warning: Whenever handling furnace heat lamps, special care must be taken not to touch the surface of the lamp. Leftover salt from handling the lamps can cause hot spots which can reduce lamp performance or cause failure.

If the cleanliness of a heat lamp is suspect, clean the lamp with isopropyl alcohol and wipe with a lint-free cloth prior to use.

C. Lamp Removal

All power should be removed from the furnace before replacing lamps.

1. If Plenum covers are supplied, remove the setscrews securing the plenum clamps and carefully remove plenum covers. Care must be taken not to damage the rubber seal between the plenum chamber and the chamber cover.
2. Short one lamp from each zone to the furnace frame to remove any charge residing in the lamps.
3. Taking care not to disturb the ceramic insulating blocks, use one of the 3/8" wrenches to hold the base nut while you loosen the fastening nut.

Warning: If the furnace is equipped with the hermetic seal (Option □), any cracks to the insulating block will result in furnace chamber leaks. Replace if broken.

4. Disconnect the element lead from the insulating terminal block. Repeat this step for the opposite side.
5. Remove lamp and old packing material.

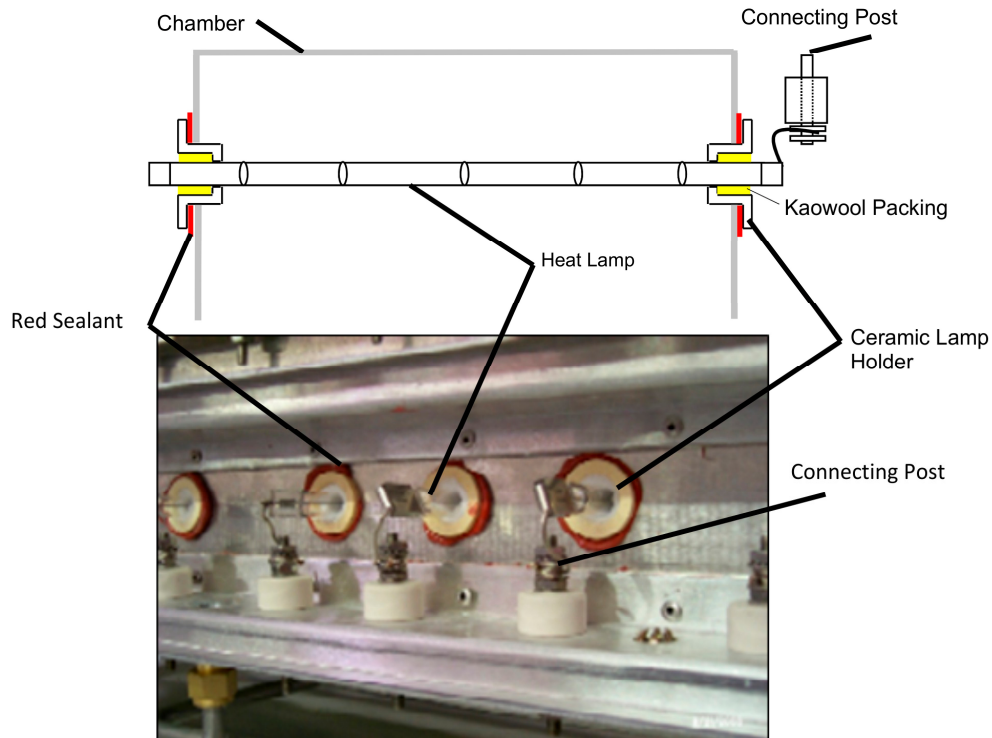

Figure 7-37 Lamp Replacement
Cross-section Across-the-Belt Diagram (top), End View Picture (bottom)

D. Lamp Installation

1. Make sure the red sealant securing the ceramic lamp holder is intact. Unsealed ceramic lamp holders may be resealed with Kaowool packing.
2. Using a lint free cloth or protective gloves, remove the lamp from its carton being very careful not to touch the glass with bare hands.
3. Straighten the connecting lead on one end of a new lamp and slide it into place. You may need the flashlight to locate the opposite side's ceramic holder. Once the lead appears from the ceramic holder, you may carefully pull the lamp through the furnace chamber.
 If threading the lamp is difficult. Thread a dowel or stiff wire through the furnace. Tape the lead to the dowel or wire and then pull the lamp into position.
5. Pack the ceramic holders on both sides with the Kaowool packing material.
6. Center the lamp to $\pm 1/32$ -in. (± 0.8 -mm) and recheck the packing.
7. Wrap the connection leads around the connection terminals in the same direction as the nut will be tightened. Use two wrenches, as you did when removing the connection, to ensure the connection post is not disturbed.
8. Cut off excess connection wire.
9. Replace plenum covers being careful not to damage the rubber seal.

Chapter 7



7.9 Calibration

7.9.1 Calibrate SCRs

Calibration of the SCRs is usually necessary only if an SCR or SCR controller is replaced. Good maintenance practice, however, is to check SCR calibration every 6 months or so, or if the furnace seems to be slower than usual to reach operating temperature.

This calibration procedure will require use of an RMS responding voltmeter/multimeter and a thin blade screwdriver, and will require that the access cover to the control enclosure be opened.

Caution: dangerous voltages and current will be present throughout the inside of the control enclosure and on wire connections to the furnace lamps when the furnace MAIN POWER lamp is ON.

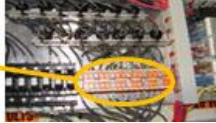
Action	Comments/Changes
1. Open the control enclosure rear access cover.	Remove the 4 screws along the top of the access cover and allow the cover to open flat. Opening this cover will shut off all power to the furnace (when interlock switch opens).
2. Locate SCRs on far left side of rear access cover.	 <p>SCRs & Controllers</p>
3. Identify DIP switch and maximum voltage potentiometer on SCR controllers. Note that DIP switch body may be a color other than blue, but the switches are always white.	 <p>SCR Controller DIP Switch (Blue with 6 white slide switches) Maximum Voltage Potentiometer (Blue with yellow pot adjustment)</p>
4. Locate lamp terminal block TB6.	 <p>TB6 Location</p>
5. Pull out interlock switch shaft to "maintenance" position.	Caution: Dangerous voltages and current are now present throughout the control enclosure and on wire connections to the furnace lamps.
6. Check/adjust process gas flowmeters.	Ensure process gas is ON. Adjust LAMP SEALS gas flowmeter to at least 25 L/m flow rate.
7. Push CONTROLS green button.	Powers up the control system.
8. Turn zone switch(es) ON for only the TOP lamps in the zone(s) to be calibrated. All other zone switches should be OFF.	
9. Push LAMPS green button.	Turns LAMPS ON.
10. Press the CALIBRATE pushbutton (ON).	Sends calibration signal to selected SCRs.

Action	Comments/Changes																				
<p>11. With the voltmeter, probe these TB6 terminals for AC RMS voltage:</p>	<p>TB6 Probe Point Labels </p> <p>For SCR 1, probe TB6 103 (gray) and TB6 105 (orange)</p> <p>For SCR 2, probe TB6 128 (gray) and TB6 130 (orange)</p> <p>For SCR 3, probe TB6 153 (gray) and TB6 155 (orange)</p>																				
<p>12. Rotate yellow screw on SCR potentiometer CCW to the stop. Then rotate CW until these voltages appear on the voltmeter at the probed TB6 terminals. To maximize both power and lamp service life, DO NOT EXCEED these values:</p>	<table border="1"> <thead> <tr> <th data-bbox="776 592 945 655">Facility Power</th> <th data-bbox="951 592 1107 655">All SCR1 & 3</th> <th data-bbox="1114 592 1269 655">High-Power SCR2</th> <th data-bbox="1276 592 1432 655">Standard SCR2</th> </tr> </thead> <tbody> <tr> <td data-bbox="776 663 945 695">208 Vac</td> <td data-bbox="951 663 1107 695">176 Vrms</td> <td data-bbox="1114 663 1269 695">176 Vrms</td> <td data-bbox="1276 663 1432 695">176 Vrms</td> </tr> <tr> <td data-bbox="776 697 945 728">220 or 380 Vac</td> <td data-bbox="951 697 1107 728">176 Vrms</td> <td data-bbox="1114 697 1269 728">176 Vrms</td> <td data-bbox="1276 697 1432 728">187 Vrms</td> </tr> <tr> <td data-bbox="776 730 945 762">230 or 400 Vac</td> <td data-bbox="951 730 1107 762">176 Vrms</td> <td data-bbox="1114 730 1269 762">176 Vrms</td> <td data-bbox="1276 730 1432 762">195 Vrms</td> </tr> <tr> <td data-bbox="776 764 945 795">240 or 415 Vac</td> <td data-bbox="951 764 1107 795">176 Vrms</td> <td data-bbox="1114 764 1269 795">176 Vrms</td> <td data-bbox="1276 764 1432 795">204 Vrms</td> </tr> </tbody> </table>	Facility Power	All SCR1 & 3	High-Power SCR2	Standard SCR2	208 Vac	176 Vrms	176 Vrms	176 Vrms	220 or 380 Vac	176 Vrms	176 Vrms	187 Vrms	230 or 400 Vac	176 Vrms	176 Vrms	195 Vrms	240 or 415 Vac	176 Vrms	176 Vrms	204 Vrms
Facility Power	All SCR1 & 3	High-Power SCR2	Standard SCR2																		
208 Vac	176 Vrms	176 Vrms	176 Vrms																		
220 or 380 Vac	176 Vrms	176 Vrms	187 Vrms																		
230 or 400 Vac	176 Vrms	176 Vrms	195 Vrms																		
240 or 415 Vac	176 Vrms	176 Vrms	204 Vrms																		
<p>13. Repeat steps 12 and 13 for all SCRs being calibrated.</p>	<p>A built-in timer will shut off the calibration signal after 2 minutes. If you need more time to complete the calibration process, press the CALIBRATE pushbutton to turn on the signal for another 2 minutes.</p> <p>During the calibration process, the lamps selected to be ON will gradually heat the zones as can be seen from the PV display on each controller. If zone temperatures exceed 500 °C, let the zones cool down below 250 °C before continuing.</p> <p>It is a good idea to allow the transport belt to stay on during calibration to help remove any excess heat from the zones.</p>																				
<p>14. When finished, press LAMPS red OFF button.</p>	<p>Turns lamps OFF.</p>																				
<p>15. Push CLEAR button.</p>	<p>Turns calibration signal OFF.</p>																				
<p>16. Close the control enclosure rear access cover.</p>	<p>Replace the 4 screws along the top of the access cover to seal the control enclosure.</p> <p>The SCR calibration process is now complete.</p>																				

Chapter 7

7.9.2 Belt Speed Measurement

The belt speed has been calibrated at the factory. The actual belt speed can be verified by the following procedure.

Tools Required: Tape Measure & Stop Watch.

- 1 Measure the distance from the furnace entrance gate to the exit gate.
- 2 Set the belt to the desired speed (Figure 7-39). (Set belt to the maximum speed if you plan to reprogram the Belt Speed Display meter.)
- 3 Place an object on the belt to act as a marker
- 4 Start the timer as the marker enters the entrance gate.

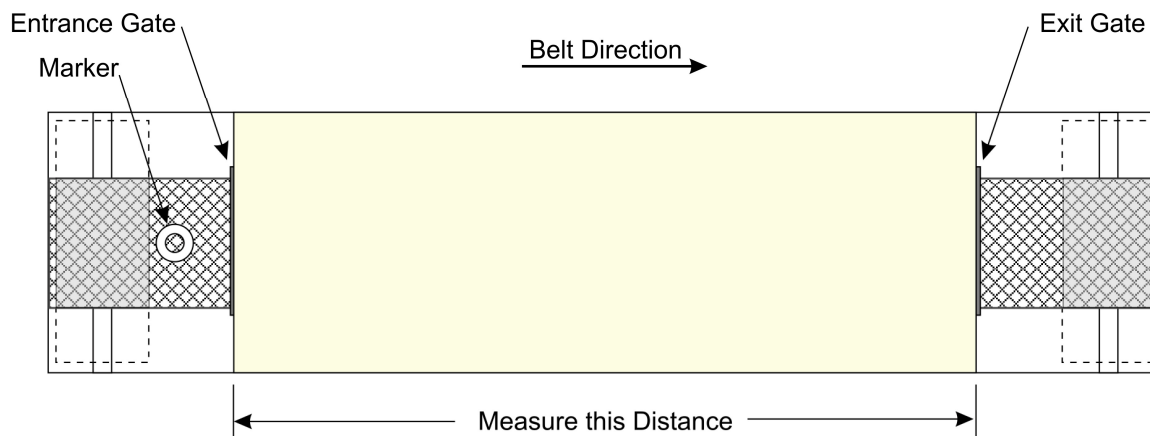

Figure 7-38 Belt Speed Calibration Diagram

- 5 When the marker on the belt reaches the exit belt tray, stop the timer. Record the time in seconds.

CALCULATE ACTUAL BELT SPEED:

Convert the measured distance from **step 1** above to inches.

Convert the time from **step 5** to minutes.

Compute the actual belt speed according to the following equation:

$$\text{Speed} = \frac{\text{Distance (in.)}}{\text{Time (min.)}}$$

SPEED ADJUST: Belt speed may be changed at any time whether the lamps are ON or OFF. However, for best practice:

4. Before lamps are turned ON, set the control system to Manual by pressing CALIBRATE button for 5 seconds,
5. Adjust SPEED ADJUST knob until proper belt speed is displayed.
6. Display will fluctuate, press CLEAR button immediately when desired speed is displayed to lock in the value.

Figure 7-39 Speed Adjust Tips

7.9.3 Belt Speed Display Calibration

A. Recalibrate Maximum Speed

The belt speed rate meter displays the belt speed as a linear function of the pulses at maximum speed. If you need to reprogram the Belt Speed Display maximum speed value or just want to change the display units (from mm/min to cm/min or cm/min to ipm for example):

- ❶ Configure the Belt Speed display for PROGRAM Mode as described in section 7.9.4C.
- ❷ Verify **dEC.Pt** so max speed shows 3 significant digits (**0.00** for <20 ipm, **00.0** for >20 ipm).
- ❸ Verify **LO-Udt=1** and **HI-Udt=5** (see Table 7-5).
- ❹ Press **CALIBRATE** button 5 seconds for Manual Mode. Turn Speed Adjust knob full clockwise for maximum speed. See (Figure 7-39).
- ❺ Follow the steps in section 7.9.2 to determine MAXIMUM BELT SPEED.
- ❻ Convert the Maximum Belt Speed to the desired units: mm/min; cm/min; inches/min or any other speed unit of measure desired.
- ❼ Enter the converted MAXIMUM BELT SPEED in the Belt Speed Display **Rt-dSP** field.
- ❽ Verify the belt speed display order of magnitude. If belt speed reads 1/10 or 10x expected value, multiply **Rt-dSP** value by 10 or divide by 10 respectively, enter the new **Rt-dSP** value and confirm display is correct.
- ❾ Reset Display to OPERATOR Mode as described in 7.9.4J.

B. Reprogram Belt Speed Display

The Belt Speed Display may need to be reprogrammed if you change motor, motor controller, motor controller settings and/or gearing. If you do need to reprogram the Belt Speed Display:

- ❶ Configure the Belt Speed display for PROGRAM Mode as described in section 7.9.4C.
- ❷ Set **dEC.Pt** so max speed shows 3 significant digits (**0.00** for <20 ipm, **00.0** for >20 ipm).
- ❸ Verify **LO-Udt=1** and **HI-Udt=5** (see Table 7-5).
- ❹ Set, **Rt-dSP=1000**; **RT-inP=10000** (to display actual pulses as multiple of 10).
- ❺ Press **CALIBRATE** button 5 seconds for Manual Mode. Turn Speed Adjust knob full clockwise for maximum speed. See (Figure 7-39).
- ❻ Follow the steps in section 7.9.2 to determine MAXIMUM BELT SPEED. While measuring Maximum Belt Speed, record average number of pulses shown on Belt Speed Display.
- ❼ Convert the Maximum Belt Speed to the desired units: mm/min; cm/min; inches/min or any other speed unit of measure desired.
- ❼ Enter the converted MAXIMUM BELT SPEED in the Belt Speed Display **Rt-dSP** field. Enter the average of the recorded pulses in the **Rt-inP** field.
- ❽ Verify the belt speed display order of magnitude. If belt speed reads 1/10 or 10x expected value, multiply **Rt-dSP** value by 10 or divide by 10 respectively, enter the new **Rt-dSP** value and confirm display is correct.
- ❾ Reset Display to OPERATOR Mode as described in 7.9.4J.

7.9.4 Belt Speed Display Meter Programming

A. OPERATOR MODE

The **Belt Speed** digital display meter shows the belt speed in inches per minute (ipm), or millimeters per minute (mm/m), or centimeters per minute (cm/min), or almost any other preferred units for speed.

In the Operator Mode the **PAR**, **▼** and **▲** are only used to change the display settings and should be disabled during normal furnace operation.



Figure 7-40 Belt Speed Display Meter

B. PROGRAMMABLE PARAMETERS

The Belt Speed display meter is a digital tachometer configured for the furnace ordered. To change the display units or any other parameter requires enabling the PROGRAM MODE to enable the display buttons: **PAR**, **▲** and **▼**. The Belt Speed indicator has five programmable parameters which are entered in the sequence shown in Table 7-5.

Table 7-5 Belt Speed Tachometer Parameters				
Parameter	Display	Value (default) mm/min	Value (default) cm/min	Value (default) in/min
Decimal Position	DEC.PE	00.0	00.0	00.0
Low Update Time	LO-UDt	1	1	1
High Update Time	HI-UDt	5	5	5
Rate Scaling Display Value (Max Belt Speed)	RE-dSP	measured max speed, mm/min	measured max speed, cm/min	Measured max speed, in/min
Rate Scaling Input Value (pulses per second)	RE-i nP	# of pulses at max speed	# of pulses at max speed	# of pulses at max speed
End	End			

C. CONFIGURE FOR PROGRAM MODE

The **PAR**, **▼** and **▲** are disabled during normal furnace operation. To reprogram the Belt Speed Display requires shutdown of the furnace and enabling the Program Mode via dip switch on the back of the display. This requires opening the Control Enclosure.

1. Shut off the furnace power and open the back of the control enclosure.
2. Find the 6-position dipswitch on the back of the digital tachometer. Move the program disable switch number 5 from OFF to ON to enable the display buttons.
3. Start the furnace.
4. Press the **PAR** key to enter Programming Mode. The meter briefly displays **PRP** followed by the first programming parameter described in the table below. Pressing the **▼** moves the selection to the right to select the digit position in the parameter value. Pressing **▲** increments the selected digit or parameter value.
5. Pressing the **PAR** key saves each entered value.

D. LOW UPDATE TIME - DISPLAY UPDATE (0.1 to 99.9 seconds)

The Low Update Time is the minimum amount of time between display updates. The factory setting of 1.0 allows a minimum of one second between updates. Low values below 0.3 will update the display correctly, but may cause the display to appear unsteady.

E. HIGH LOW UPDATE TIME - DISPLAY ZERO (0.1 to 99.9 seconds)

The High Update Time is the maximum amount of time before the display is forced to zero. The High Update Time must be higher than the Low Update Time and also higher than the desired slowest readable speed (one divided by pulses per second). The factory setting of 5.0 will force the display to zero for speeds below 0.2 Hz or one pulse every 5 seconds.

F. RATE SCALING DISPLAY VALUE (0 to 999999)

Enter the maximum Belt Speed value for the units selected.

G. RATE SCALING INPUT VALUE (0 to 99999.9)

The Rate Scaling Input Value is the number of pulses that corresponds to the maximum belt speed.

H. PROGRAM MODE END

The Belt Speed display meter exits the Programming Mode when the PAR key is pressed to save the Rate scaling value. The meter briefly displays End upon exiting Programming Mode. All programmed selections are now transferred to the non-volatile memory and the meter returns to the Belt Speed display. (If power loss occurs during Programming Mode, verify parameter changes and reprogram, if necessary, when power is restored.)

I. PROGRAM MODE TIMEOUT

The Belt Speed display meter has an automatic time out feature. If no keypad activity is detected for approximately 60 seconds, the meter automatically exits the Programming Mode. The meter briefly displays  and returns to the Belt Speed display. When automatic timeout occurs, any changes that were made to the parameter currently being programmed will NOT be saved.

J. RESET DISPLAY TO OPERATOR MODE

To completely exit Programming Mode and return the Belt Speed display meter to Operator Mode, lockout the display buttons via the dip switch on the back of the display. This requires opening the Control Enclosure.

1. Shut off the furnace power and open the back of the control enclosure.
2. Find the 6-position dipswitch on the back of the digital tachometer. Move the program disable switch number 5 from ON to OFF to enable the display buttons.
3. Start the furnace

The  key,  and  are disabled during normal furnace operation.

7.9.5 Thermocouples

The thermocouples are type K and are pre-calibrated. They do not require any additional calibration.

7.9.6 Low Gas Pressure Switch Calibration

Inlet Pressure Switches are installed on the process gas manifolds. These switches are normally open. They close when proper pressure is present in the process gas supply lines.

The switches are set to open when pressure falls below set points in the following table:

Port	Manifold	Pressure	
Gas 1	CDA or Nitrogen	55-60 psig	3.8-4 Bar
Gas 2	Nitrogen Forming Gas, or other (Option)	55-60 psig	3.8-4 Bar

The pressure switch set points can be adjusted manually. Locate the switch in the process gas supply line. To increase the set point turn the wheel clockwise. Turn the top of the switch counter clockwise to decrease the pressure set point so the alarm will not occur until the pressure drops to a lower point.



Figure 7-41 IPS Inlet Pressure Switch

A. Gas Supply Low Pressure Switch Calibration

The process gas pressure switch is located on the gas supply manifold for each gas supplied.

If a reservoir tank is supplied, the pressure switch is located at or near the compressed air receiver. See drawing 802-101780-01.

B. Calibration

To calibrate each switch:

- 1) Verify that the Low Pressure Alarm switch is enabled.
- 2) Close all flowmeter valves.
- 3) Set inlet air pressure to desired set point pressure. Read pressure on supply gage.
- 4) Rotate the Adjusting Wheel:
 1. CW -Clockwise to increase the pressure set point below which the alarm will trip.
 2. CCW - Counterclockwise to decrease the pressure set point so the pressure must drop to a lower value to trip the alarm.
3. You can hear a faint click when the micro switch changes state. Below this point below which the switch will activate the alarm when enabled.
- 5) Start the furnace system without power to the lamps. Close the facility process gas valve to the furnace. Open the flowmeter valves and verify that the alarm trips when the pressure drops below the new set point.
- 6) Readjust as necessary and retest.

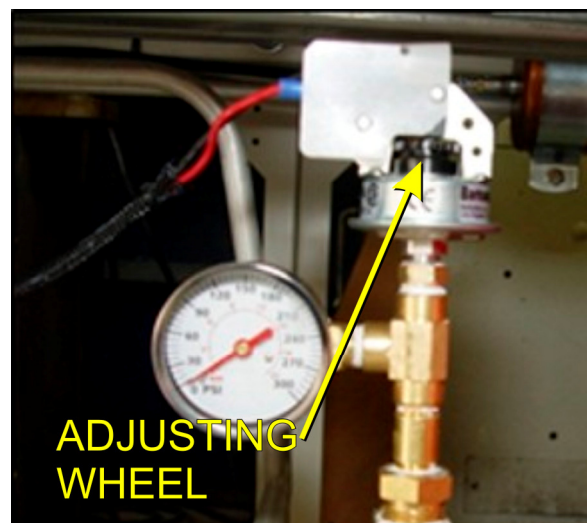
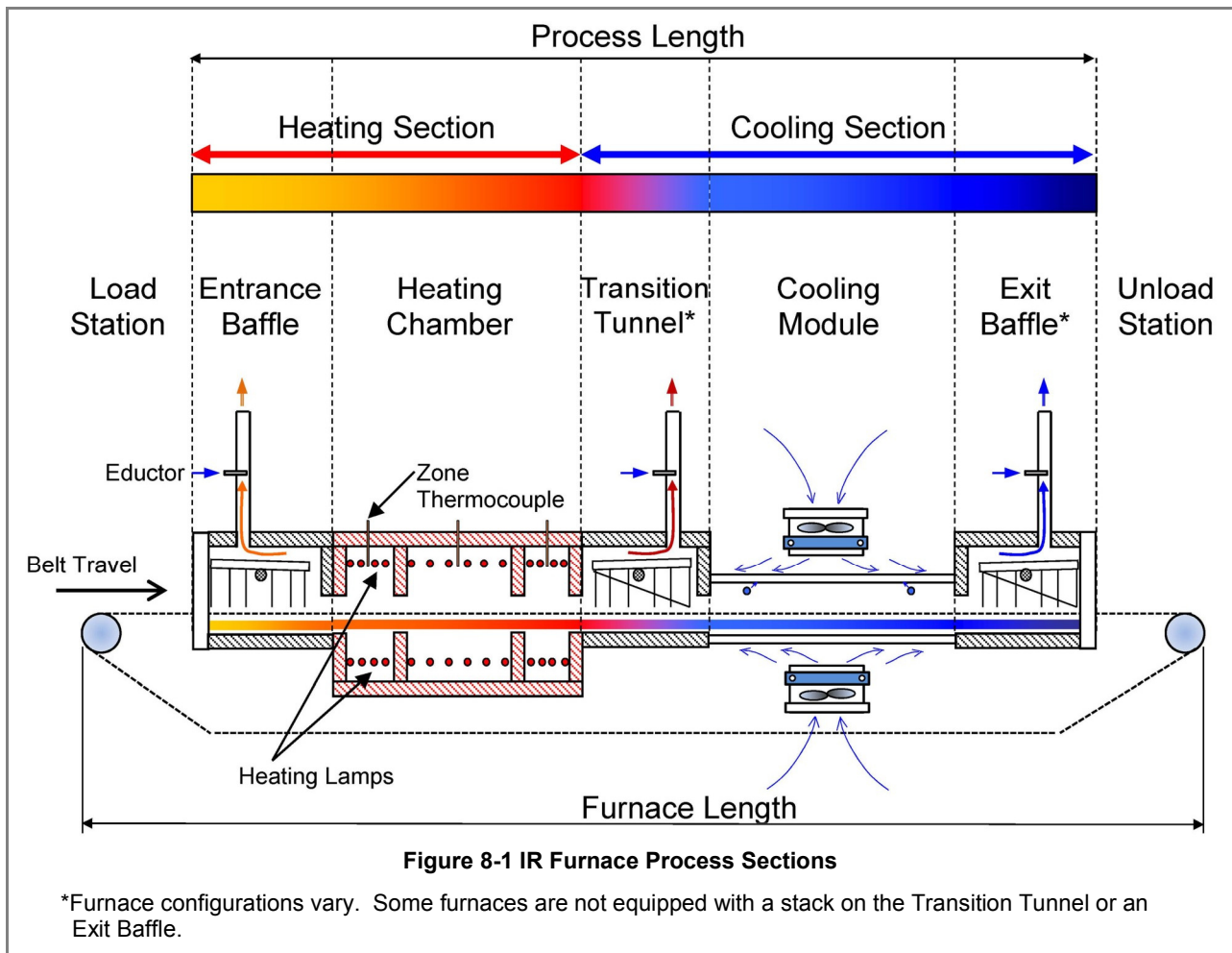

Figure 7-42 Air Pressure sensor

8.1 IR Furnace Process

The infrared furnace continuously processes product on a moving belt. Each product moves through the same areas and is exposed to the same process elements. The furnace process sections are shown in Figure 8-1.



Continuous IR Processing is generally characterized by rapid ramping rates, ability to vary temperatures greatly from zone to zone and consistent processing performance in a controlled atmosphere. Establishing an acceptable profile and stabilizing the furnace are key to successful thermal processing. This is done by managing the following:

- Zone Temperatures
- Belt Speed
- Process Gas inflow
- Balancing the Gas flow using exhaust venturi flow
- PID Loop and Zone Power adjustments

8.1.1 Zone Temperatures

Set zone temperature controllers so that the furnace can easily achieve the required temperatures in each heating zone.

8.1.2 Belt Speed

If the profile temperatures are acceptable, but the period is too long or short, vary the belt speed to achieve the required retention time. Increasing belt speed reduces process time, reducing belt speed increases time at temperature. Adjusting belt speed will also affect ramping time. Be careful to keep belt speed low enough to assure the product has adequate time to cool before it reaches the exit belt roller.

8.1.3 Process Gas Inflow

Process gas introduced into the furnace through the chamber walls serves to keep the lamps ON and thereby improving process control. Too much gas will force lamps ON and use more power than may be necessary. Too little gas will allow the lamps to shut OFF. While the furnace is coasting, it is out of control and may result in uneven results.

The process gas flow can be adjusted to replenish the gas in each zone by multiples of the volume of that zone. Replenish rates for normal processing are 1-2x. If processing requires very low moisture and/or oxygen concentrations below 20 ppmv, higher replenish rates in the zones may be required to achieve good results. See section 8.5 Gas Flow through 8.5.5 Process Gas Flow Guidelines for detailed information of gas flow replenish rates and balancing the furnace.

8.1.4 Balancing the Gas Flow

Once the process gas inflows are set, the exhaust stacks must be adjusted for the type of environment desired. If the process being run requires very low moisture and/or oxygen concentrations, the furnace atmosphere should be positive (internal pressure higher than the pressure of the room). To establish a positive atmosphere in the furnace, sum the inflows, subtract excess gas amount (typically 50-200 Lpm) and divide by 15 to determine the stack exhaust flow settings.

If the process may give off volatile or poisonous gas, set the furnace to neutral or negative atmosphere (furnace internal pressure lower than room atmospheric pressure). To achieve a negative atmosphere, sum the inflows, add excess gas amount (typically 50-200 Lpm), and divide by 15 to determine the stack exhaust flow settings.

The furnace eductors are designed to extract the process gas from the furnace and cooling section internals at approximately 15 times the flow to the stack eductor. For example to extract 250 Lpm from the furnace via the stack, set the stack flow to 17 ($250/15 = 16.67$). See section 3.4 Functional Checkout for recommended initial settings. See sections 8.5 through 8.8 for process engineering considerations.

8.1.5 PID and Zone Power

While the furnace PID settings are preset at the factory, sometimes a process requires adjustment of these parameters to achieve desired results. In addition on computer controlled furnaces, adjusting the zone power settings can dampen furnace performance. Increasing zone power will increase furnace responsiveness.

In a furnace with independent zone controllers, the Autotune feature can aid in optimizing zone controller performance. See section 5.2 Controller PID Tuning and 8.4 PID Tuning for more details.

8.2 Furnace Construction

The heating chamber technology allows for rapid heat-up and cool-down times. Stable temperatures of up to 1000°C can often be reached in less than 20 minutes. Radiant heating allows for rapid startups and profile changes and system stabilization.

The heating chambers consist of an outer metallic shell fabricated from either aluminum or stainless steel, lined with a refractory-ceramic-fiber (RCF) insulation. Controlled atmosphere heated sections allow process gas to pass through the RCF insulation.

8.2.1 Modules

The furnace is constructed from a number of basic modules which make up the furnace length.

For example, the standard LA-306 is comprised of 7 modules

Module 1 – Loading Station

Module 2 – Entrance Baffle

Module 3 – 3-Zone Heating Chamber Module

Module 4 – Transition Tunnel

Module 5 – Controlled Atmosphere Cooling Module

Module 6 – Unloading Station

In some applications, longer cooling sections are required. Additional controlled atmosphere cooling modules, a water cooling system, or a forced air cooling module after the exit baffle may be added.

Another application may call for a longer heating section with an additional 4-Zone heating chamber module.

Every furnace heating chamber is constructed with 30-in. (76-cm) modules. Depending upon application requirements, the furnace can be configured for any size up to 16 zones. Each furnace is a custom arrangement from standard design modules, the layout and overall design is completed prior to the start of fabrication.

8.2.2 Throat

The throat of the furnace describes the maximum height of any product allowable through the process section. Depending upon configuration, throat clearance can range from 0.75 to 4 inches. The throat height has a significant impact on the thermal process profile as gas flow between chambers is significantly increased as the throat is increased.

Warning: Feeding items through the furnace that exceed the throat clearance will damage furnace zone separators and may reduce furnace performance.

8.3 Heating Chamber Design

8.3.1 Zones

The heating chambers are divided into individually controlled **zones**. Each 30" chamber module can be divided into 1, 2, 3 or 4 zones. If the furnace requires more than 4 zones, additional heating chamber modules must be added. The zone configuration of your furnace depends on the type of processes your furnace will be running and is part of the project furnace design specification.

8.3.2 Infrared Heating Chamber

The chamber is insulated with a porous material and if the furnace is used in a controlled atmosphere application, pressurized process-gas entering **plenums** at the top and bottom diffuses through the porous insulation and enters the process area. The gas enters in high volume and with low velocity. As the gas diffuses, it becomes heated to the bulk temperature of the zone.

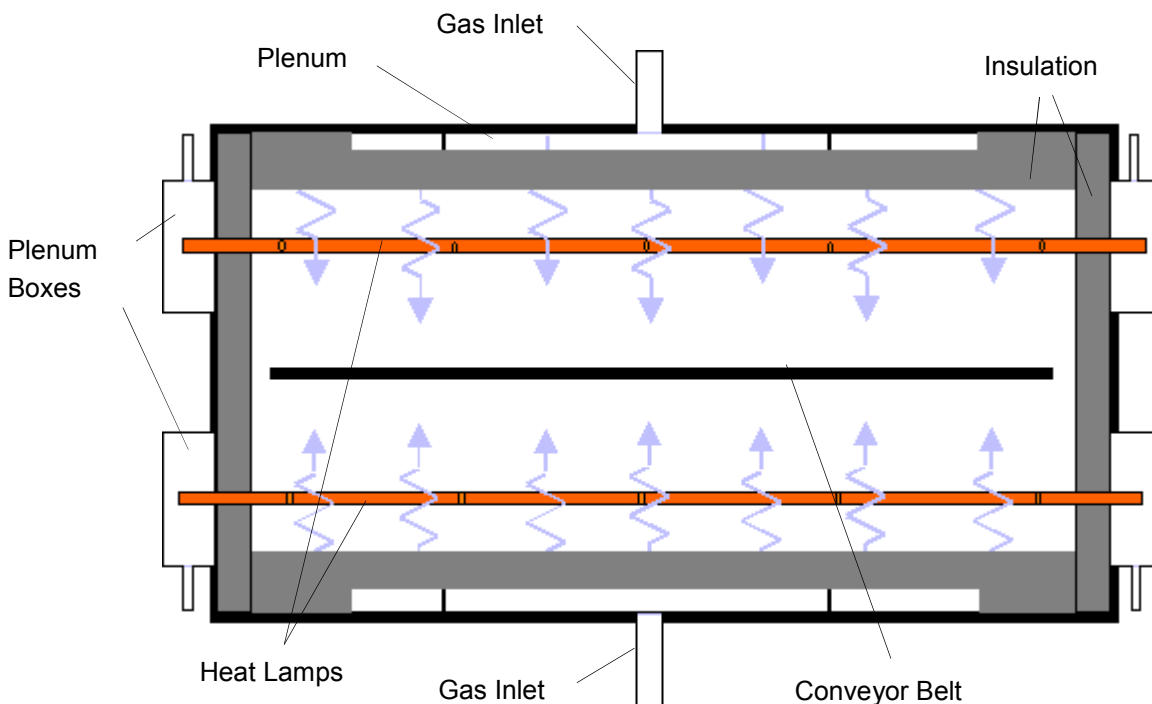

Figure 8-2 Heating Chamber Construction. End view

Plenum boxes may be specified and included as part of the hermetic seal option, which allows a light positive pressure to be applied to the ends of the heat lamps forming a highly controlled atmosphere condition.

Correctly balancing the airflow contributes greatly to the cleanliness of the chamber. When properly balanced, a high volume gas-flow is present from both top and bottom of the chamber. Effluents released from your product are swept along the centerline of the chamber to the exhaust ports, and do not rise to contact the upper surfaces or fall to contaminate lower surfaces.

Incoming process gas introduced through a large displacement area provides rapid purge times and low contamination levels. Typically, a process environment atmosphere of less than 10 parts Oxygen in 1,000,000 parts Nitrogen (<10ppm O₂) can be achieved within about 10 minutes. Rapid purge times also allow for quick process environment replenishments as well as fast cool-down times.

8.3.3 Energy Type for Applications

Types of Energy. The ability to turn banks of lamps off and on via the zone switches on the ENERGIZE LAMPS panel allows the user great flexibility in applying energy to each zone. Use just the top lamps in each

zone for drying moisture or volatile organic compounds from the top surface of substrates or trays, or curing thermosetting compounds or coatings on wafers or polycarbonate materials. Use both top and bottom lamps in traditional furnace applications. Use just the bottom lamps to emphasize conduction heating of parts from the transport belt and from IR radiation on the bottom of metallic or ceramic parts carriers.

8.3.4 Placement

Lamp configuration within each zone is determined to achieve optimal power consumption based on the type of processes specified by the owner operator. Heat lamps can be packed closely together where high temperatures need to be reached quickly. For Holding Zones where rapid rises to high temperatures are not required, lamps are usually spaced further apart.

8.3.5 Wiring

Heating lamps are wired differently for each furnace. The actual amount of power available to each lamp is based upon the heat lamp wiring configuration and the AC input voltage. Lamps may be wired in parallel providing the highest available power to the individual lamp or in series, splitting the power with other lamps. Most systems are wired in a series-parallel configuration to optimize the use of available voltage and minimize current flow. Refer to the wiring diagram in the Operating Manual for heat lamp wiring details for a specific furnace.

8.4 PID Tuning Concepts

When the furnace is in operation, the power supplied to the lamps is under constant control. A special performance control is used to maintain consistent zone temperatures by adjusting the current allowed to reach the heat lamps. The control is referred to as a PID control loop. The name PID stands for **P**roportional + **I**ntegral + **D**erivative and represents the three terms used in the control loop.

When PID tuning, any changes that are made are sent directly to the controller modifying the way the controller responds to deviations from setpoint. Tuning the furnace allows the engineer to precisely control the temperature profile inside the furnace.

A complete understanding of how a PID loop works and how to tune it will greatly benefit the owner operator and product results.

In general, the PID equation takes on the following form:

$$CO = G \cdot \left\{ (S - T) + \frac{1}{I} \int_0^{1\text{sec}} T \cdot dt + D \cdot \frac{dT}{dt} \right\}$$

Where:

T = Temperature

t = Time

G = Gain Term Value

S = Setpoint Temperature

I = Integral Term Value

D = Derivative Term Value

The output from the three terms, the proportional, the integral and the derivative terms are summed to calculate the output of the PID controller. The following paragraphs review and explain the three components of the PID equation.

8.4.1 Gain

The proportional band is adjusted according to the following equation

$$PB \text{ } ^\circ\text{C} = 100 \text{ } ^\circ\text{C} / \text{Gain}$$

The higher the gain, the narrower the proportional band; the lower the gain, the wider the proportional band.

The gain value multiplies the difference between the setpoint and actual temperature. The difference between these two values is referred to as the **error**. (This does not mean that anything is wrong). The error is measured continuously, about once a second. When this difference is large, power to the heat lamps will be increased, or decreased, accordingly. When the error is small, power to the heat lamps will be maintained at present levels. Gain values greater than 1 amplify the controller's response to error (differences between temperature and setpoint).

Setting the gain too high will result in temperature over and under shoots. It is possible that the temperature will never reach a stable state. The temperature might oscillate around the setpoint.

Setting the gain too low will result in a slow response to temperature changes. The furnace will take longer to reach operating temperatures and will be slower to recover from temperature drops as the product soaks up heat.

Note: Since the gain value is a multiplier, it should not be set to zero.

Default values for gain vary for each zone and temperature setpoint range. Gain is typically set at default values from **40** to **95** for most applications.

8.4.2 Integral

With only gain operating, and no value set for integral and derivative, the controller acts somewhat like a thermostat. When the difference between temperature and setpoint (error) is zero, power to the heat lamps is maintained at current levels. When the temperature drops below the setpoint, power is increased until the temperature returns to the setpoint. This PID setting results in an operating condition where the measured temperature is often inappropriately far from the temperature setpoint.

The integral value is used to rapidly converge on the set point.

The **integral value** refers to the integer value entered in the recipe screen. The **integral term** is calculated automatically by the controller. The integral value multiplies the integral term.

The Integral term in the PID equation represents the average error (temperature difference) over a time interval of about one second and is updated continuously, accumulating error as a function of time.

The integral product (**integral value** multiplied by **integral term**) is added to the error. This integral product can make a significant difference to the PID control output signal especially if the current error is small.

Think of it this way: The difference between temperature and setpoint at any given time could be zero, but the average difference between temperature and setpoint over the length of time represented by the integral term is never likely to be zero. With an integral value of zero, power will be maintained at its current level even though the temperature is about to decrease. With an integral value greater than zero, multiplying the integral term, power will be increased slightly and the impending temperature drop will be not being as profound.

With a Gain and an Integral value entered in a recipe, the PID equation will always be adjusting the controller's output unless the both the **current difference** and **average difference** between temperature and setpoint is zero.

Larger integral values generate smaller responses from the controller. A value of 1, for instance, will use the entire average difference between temperature and setpoint for the correction value. A value of 2 will use half the average difference for the calculation. Entering very large integer values will have the same effect as entering zero.

Default values for integral vary for each zone and temperature setpoint range. Integral is typically set at default values from **8** to **15** for most applications.

8.4.3 Derivative

The derivative term of the PID equation is a value representing the rate of change of the temperature setpoint deviation. If, for example, the temperature deviation is accelerating away from the setpoint, the derivative term attempts to predict what the deviation will be some short time in the future. This behavior allows the derivative to sense a change in load early and attempt to counteract its effect ahead of time.

Suppose, for example, that the zone temperature is deviating downwards from the setpoint at 10°C/second. At the next measurement, the temperature is deviating downwards at a rate of 20°C/second. The derivative term will sense this acceleration away from the setpoint and counteract it by increasing the PID signal to the controller. The larger the derivative value entered in the recipe screen, the larger the correction.

A zero value may be appropriate for many processes with constant furnace loading (a continuous stream of similar parts entering the furnace).

For processes where furnace loading is uneven, such as when parts arrive from screen printers or non-buffered processes in an automated line, a non-zero derivative term may help the furnace respond more quickly when parts suddenly enter the heating zones.

Care must be taken when entering derivative terms higher than 4 due to the fast response of the IR furnace.

Detecting an accelerating deviation from setpoint requires at least three temperature measurements. Therefore, at least two seconds elapse before a correction can be made. Heat lamps are very responsive and very little amplification is needed to correct the lamp output. The derivative can show a downwards accelerating temperature deviation even though the temperature may have started increasing. This condition can result in an over correction.

Even when furnace loading is fairly constant, Derivative can vary for each zone and temperature setpoint range. Derivative is typically set at default values of **1** to **3** for most applications.

8.5 Gas Flow

8.5.1 Gas Flow Basics

The most important factor in creating a safe and efficient process environment is gas-flow balance. The volume of process gas entering the system should be equal to the volume of exhaust gas leaving the system.

Gas flow entering the oven is controlled by **flow meters**. The flow meter arrangement is different for every furnace. A flow meter can be installed to supply gas for each individual zone or for various combinations of zones.

All furnaces are equipped with gas power exhausts. Compressed gas (usually air or nitrogen) is forced through a small hole in a small tube creating a venturi effect inside the exhaust stack. The forced high-speed gas flow drags the furnace atmosphere out with it. To regulate the rate of exhaust, each venturi is supplied by its own flow meter.

Correct gas flow through the venturi is a critical factor in achieving stable temperature profiles. For this reason, exhaust stacks cannot be connected to facilities ducting. Changes in facilities-ducting pressure would change exhaust pressure that would in turn change the gas flow within the furnace. The condition will lead to alterations in the thermal process profile.

Disruptions in gas flow in the process section can be caused by the following influencers:

- Close proximity of doors
- Close proximity fans
- Placing a furnace through a wall between rooms
- Attaching facility exhaust ducts directly to the furnace exhaust stack

8.5.2 Process Gas

Various forms of process gas can be utilized inside furnaces. Users may want to operate a pure N_2 , O_2 or H_2 environment. Others will only need clean dry air (CDA). Whatever the case, the furnace can be factory configured in different ways to meet specific requirements. The following are some possible process gases.

A. Nitrogen

Many processes require the process environment be free, or almost free, of oxygen as the products would either burn or oxidize. Removing oxygen involves forcing the oxygen out by pumping in another gas. A relatively inert gas such as nitrogen is normally used for this purpose.

B. Forming Gas

Forming gas is the term used to describe any mixture of N_2 and H_2 gas. Without the Hydrogen option, only non-combustible gas can be used safely with the LA-306.

C. Hydrogen

Other gases having a beneficial effect on a process can also be introduced into the process environment. Hydrogen, for example, is commonly used in reflow soldering processes to facilitate solder flow. Without the Hydrogen option, only non-combustible gas can be used safely with the LA-306.

All processes with concentrations of H_2 higher than 4% mass percent require all H_2 automated safety features. When the concentration of H_2 gas required for the process falls below 4%, H_2 levels will not reach an explosive concentration inside a furnace.

8.5.3 Creating an Optimum Process Environment

To establish a process environment, the engineer will need to start with the number of times the air surrounding the product will need to be replenished. This figure depends very much on the process requirements and costs. Some processes give off large quantities of volatiles that will need to be removed, requiring higher gas flow rates than other, cleaner processes. The cost of the process gas will also need to be taken into account, as quick replenishment times will use significant volumes of gas. For new processes, it may be safest to start with a high gas flow rate that can be adjusted downwards until the test product stops coming out clean.

The first step in calculating the flow rates will be to calculate the internal volume of the furnace chamber and multiply the answer by the number of times per hour that the atmosphere needs replenishing. The result is the total gas flow per hour for the chamber.

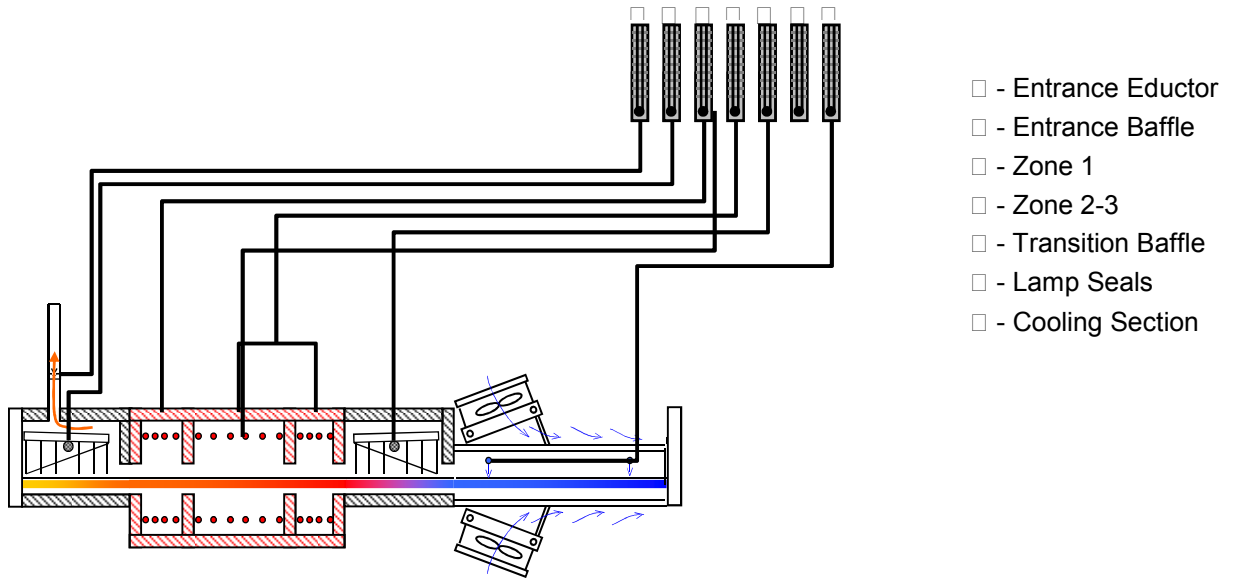

A. Calculate the Internal Volume of an LA-306 Furnace

Example 1:

The process engineer determines the thermal process **replenish time** is 30 seconds.

Given: Replenishment Requirement: 30 seconds / replenish

Belt Width: 6 in.

Process Section Dimensions (Not including Open Air cooling modules)

The better the estimate of internal volume, the less tuning required.

	L (cm)	W (cm)	H (cm)	V (cm ³)
Entrance Baffle	38	17.8	15.2	10 324
Zone 1	19	17.8	22.9	7 8743
Zone 2	38	17.8	22.9	15 486
Zone 3	19	17.8	22.9	7 743
Trans Tunnel	38	17.8	15.2	10 324
Cooling	76	17.8	15.2	20 648
Lamp Seals	305	2.5	5.1	3 933
Total Internal Volume				72 267

B. Calculate Replenish Rate

Convert furnace Volume from cubic centimeters to liters:

$$\begin{aligned} 72\,267 \text{ cm}^3 / 1000 \text{ cm}^3/\text{L} \\ = 72 \text{ L / replenish} \end{aligned}$$

Convert to L/min

$$1 \text{ minute} = 60 \text{ seconds}$$

$$60 \text{ seconds/min} / (30 \text{ seconds / replenish}) = 2.0 \text{ replenishes / min}$$

$$(2.0 \text{ replenishes / min}) \times (72 \text{ L / replenish}) = 144 \text{ L / min}$$

Balancing Gas Flow, Q = 144 L/min (actual liters per minute)
--

From these calculations you can balance the furnace environment with a total gas flow of 1,444 L/min.

Note: although the above result is not true Lpm, it can be used to balance the furnace. The flowmeter scales are labeled in Lpm, but are not corrected for actual conditions. To calculate true Lpm, convert using Boyle's law:

Correct for temperature and pressure to convert from CFH to standard cubic feet per hour (SCFH), assuming the inside of the furnace is at 1 atmosphere:

$$s\text{Lpm} = a\text{Lpm} \times \frac{(\text{Std Temperature} \times \text{Actual Pressure})}{(\text{Act Temperature} \times \text{Std Pressure})}$$

$$\text{Actual Furnace Temperature, } T_1 = 38\text{C} + 273 = 311 \text{ K}$$

$$\text{Actual Pressure, } P_1 = 0 \text{ kPa} + 101.3 \text{ kPa} = 101.3 \text{ kPa}$$

$$\text{Standard Temperature, } T_s = 21\text{C} + 273 = 294 \text{ K}$$

$$\text{Standard Pressure, } P_s = 101.3 \text{ kPa}$$

$$s\text{Lpm} = 144 \times \frac{(294 \text{ K} \times 101.3 \text{ kPa})}{(311 \text{ K} \times 101.3 \text{ kPa})}$$

$$\text{True Standard Gas Flow, } Q_s = 137 \text{ sLpm (21C, 101.3 kPa)}$$

Standard liters per minute can be used to determine plant compressed air requirements.

8.5.4 Balancing Gas Flow

Once the total gas flow has been determined for the process, the process engineer can then determine the balance of the gas flow.

Balanced gas flow means that the same volume of gas enters the chamber as exits.

- ❶ First to determine the quantity of gas that should be introduced to the each heating chamber: Divide the Balancing Gas Flow among each of the heating chamber zones and baffles for which the furnace has control.
- ❷ To determine the total gas flow to the eductors, first subtract the volume excess gas flow (flow to exit from entrance and exit openings) and then divide the result by 15. The approximate volume of air drawn out by the venturi created by the eductor is 15 times the flow rate.
- ❸ Divide the total eductor gas flow among the available eductors.
- ❹ The sum of the eductor gas flow and the Balancing Gas Flow is the gas consumed by the furnace.

Refer to Example 2 example shown on the following page.

Note: A balanced gas flow does not guarantee the best or most economical environment for your process. After following this procedure, gas flow may still need adjusting to achieve an optimum and safe environment.

A. Calculate the Balancing Flow

Example 2:

Given: Desired Excess Gas Flow = 100 Lpm
 Balancing Gas Flow = 144 Lpm (from Example 1)

Gas Entering Zones

Entrance Baffle	20 Lpm	}	①
Zones 1	20 Lpm		
Zones 2 & 3	30 Lpm		
Transition Tunnel	15 Lpm		
Lamp Seals	20 Lpm		
<u>Cooling</u>	<u>+ 20 Lpm</u>		
Balancing Gas Flow in =	125 Lpm		
<u>- Excess Gas Flow =</u>	<u>80 Lpm</u>	}	②
Evacuation Gas Flow =	45 Lpm		
<u>Eductor Flow Divider</u>	<u>÷ 15</u>	}	③
Total Eductor Gas Flow =	3 Lpm		
<u>Entrance Stack Eductor</u>	<u>3 Lpm</u>	}	④

Gas Consumption

Total Gas Flow in	125 Lpm	}	④
<u>Eductor Gas Flow</u>	<u>3 Lpm</u>		
Total Gas Consumption =	128 Lpm		

This method provides a good starting point for balancing the gas flow in your furnace. It is, however, an approximate method so additional tuning will be required.

8.5.5 Process Gas Flow Guidelines

The following are guidelines for some common processes performed in furnaces.

1. If faster cooling is required – increase flow to the entrance eductor while reducing flow to the transition or exit eductor. This will prevent hot air from the heating chamber from carrying over into the cooling section.
2. For equilibrium profiles – set the flow to the zones at about the same rate. This will assist in keeping a steady flow of process gas around the product during heating.
3. For peaked or non-equilibrium profiles (i.e. solder reflow or solar cell firing) – increase flow to the middle zones and reduce flow at the beginning and ending zones, also increase flow to cooling sections. This will help the product achieve high temperature under IR radiation and allow for quick cooling.
4. In a long steady peak profile – increase flow to exit or transition eductor while reducing flow to the entrance eductor. This will draw the air to the end of the heating chamber using convection heating to assist in raising the product to its final temperature.

THERMAL PROCESSING THEORY

9.1 Infrared Waves

Infrared waves form part of the electromagnetic spectrum. Electromagnetic waves with wavelengths from 0.78 μm to 1000 μm are called infrared waves. You are already familiar with electromagnetic waves of different wavelengths. Microwaves, X-rays, radio waves and visible light are all electromagnetic waves. Infrared waves produced inside the furnace lie predominately in the near and medium infrared range with wavelengths ranging between 0.5 and 3.0- μm .

When using infrared lamps, higher heat-lamp temperatures emit higher radiant energy. This elevated energy translates to a shorter electromagnetic wavelength of emitted IR radiation. While the IR waves of a heat lamp come from a continuous range of wavelengths, the **dominant wavelength** (λ_{dom}) as given by Plank's distribution principle is the wavelength transmitted with the highest occurrence. So for a given temperature, only one λ_{dom} exists. See Figure 9-1 below.

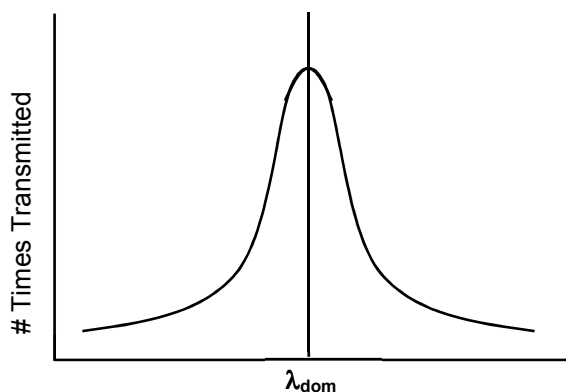

Figure 9-1 Dominant Wavelength Graph

The relationship between heat-lamp filament temperature T and λ_{dom} is given by the fixed relationship:

$$\lambda_{\text{dom}} \mu\text{m} = \frac{2897 \mu\text{m}\cdot\text{K}}{T \text{ K}}$$

To convert from degrees Celsius ($^{\circ}\text{C}$) to Kelvin (K) add 273 to the Celsius temperature value.

For example:

At 1000 $^{\circ}\text{C}$ the respective material dominant wavelength is:

$$T = 1000^{\circ}\text{C} + 273$$

$$T = 1273 \text{ K}$$

Substituting back into the given equation:

$$\lambda_{\text{dom}} = 2897 \mu\text{m}\cdot\text{K} / 1273 \text{ K}$$

$$\lambda_{\text{dom}} = 2.28 \mu\text{m}$$

9.2 Infrared Heating

Infrared (IR) heating is electromagnetic radiation emitted from the surface of IR lamps or emitters. Thermal radiation is generated when heat from the movement of charged particles within atoms is converted to electromagnetic radiation. In the furnace, radiant heating from IR lamps provides heat directly to objects without first heating the surrounding air. IR waves excite molecules within a substance (product) thus generating heat, but pass generally undisturbed through the surrounding atmosphere. Other substances such as glass, ceramics and some organic materials are also transparent to IR waves. Objects suspended in these media can, therefore, be heated directly by IR waves without directly heating the supporting media.

Not all heating in the furnaces occurs via direct IR radiation. The belt and air inside the furnace are heated via the IR lamps. In addition, edge heaters (resistance heaters installed along the furnace length) can introduce heat into the furnace. Your product also acquires heat from the edge heaters, conveyor belt and surrounding heated gas in the chamber via **conduction**.

The amount of direct heating via IR radiation is determined by three factors:

- 1) The level of IR radiation emitted from the heat lamps.
- 2) The amount of IR absorbed by a product.
- 3) The level of edge heat introduced into the furnace

If you know the **resonant frequency** of a particular substance, matching the furnace dominant wavelength the product resonant frequency ensures maximum energy transfer via IR radiation. In most cases, rapid product heating can be achieved more efficiently through frequency matching rather than with temperature increases.

9.2.1 Advantages of IR Heating

Heating via conduction and convection operates by transferring heat to object surfaces. Heat is then transferred from the surface to the layers beneath. Heat transfer, however, is not uniform, causing temperature differences and unequal expansion across an object. The unequal expansion due to the uneven heating is called thermal stress and can cause objects to fracture called thermal shock.

IR radiation heats molecules below an object's surface and allows for more uniform heat distribution than can be provided by conduction and convection heating alone.

Rapid heat up time is also achieved with IR technology due to the high energy-transfer rate of IR waves. The speed of conduction and convection heating is proportional to the temperature difference between the object and heating environment, whereas the speed of IR heating is proportional to the difference between the fourth powers of the object and environment temperatures.

For example:

Suppose the temperatures of an object were 100°C.

If a convection heating furnace were heated to 500°C, the proportional difference would be

$$500 - 100 = 400$$

If an IR furnace were heated to 500°C, the proportional difference would be

$$500^4 - 100^4 = 6.25 \text{ E}^{10} - 1.00 \text{ E}^8 = 6.24 \text{ E}^{10}$$

Other factors such as the emissivity of objects are taken into account when calculating energy transfer rates.

9.3 Thermal Process

The **thermal process** is the idealized process description for a particular product as it passes through the process section, including the product temperature profile and process environment. When establishing the thermal process, a consistent temperature profile is just as important as establishing the correct process environment.

Each dissimilar product that passes through a continuous belt Infrared furnace will likely utilize a different thermal process. Engineering design and empirical testing are the best methods of achieving the best thermal process.

9.4 Temperature Profiling

The proper thermal process is usually verified by performing a temperature profile. A temperature profile represents multiple temperature measurements taken at close intervals over a period of time through the length of the furnace. Product passing through the furnace goes through a set of temperatures known as a temperature profile.

Notice in Figure 9-2 that the green horizontal lines define the setpoint temperatures, yet the thermocouple readings do not reach the actual setpoint temperature inside each zone. Also notice that the product peak temperature may be achieved well inside the cooling section.

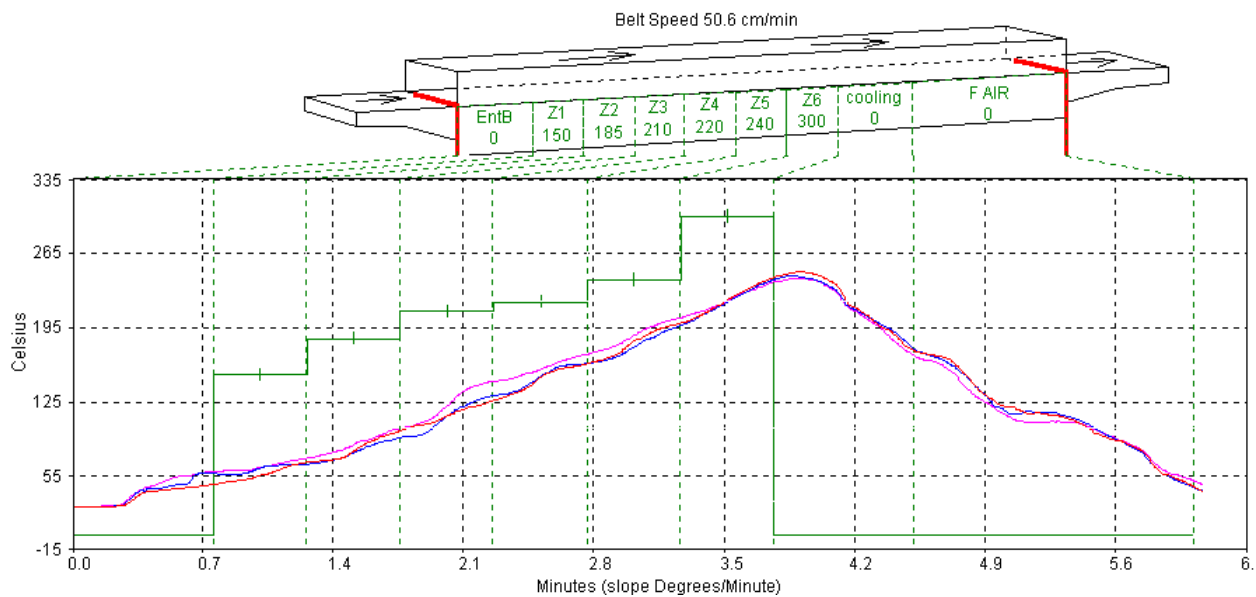

Figure 9-2 Temperature Profile

The temperature profile will be affected by the product material, mass and process gas. For example, a furnace with a controlled atmosphere cooling module installed can cool the product while in a pure nitrogen gas environment. The same temperature profile could be achieved with a forced-air cooling module, but could subject the product to a potentially hazardous oxidizing environment at elevated temperatures.

Prior to shipment, all furnaces undergo a temperature profile test. In this test, typically one or three (on furnaces with 15-inch or wider belt) thermocouples are sent through the furnace located on sample product on the conveyor belt at the center and, if three are used, one each side. All furnace zones are programmed to produce the furnace owner’s prescribed setpoint temperature and allowed to reach steady state. The thermocouple readings are expected to remain within 5% of one another. While this test is performed at the factory, it should also be performed at startup and periodically thereafter to assure that the desired temperature profile can be maintained.

9.4.1 Profiling Responsibilities

The process engineer must set the furnace process parameters to achieve the desired temperature profile with the product. To do this, the engineer must have an idea of the process cycle of the product and the important process parameters and limitations. Looking again at the temperature profile from Figure 9-2, six zones are visible labeled Z1 – Z6. Depending upon the configuration of the furnace, fewer or more zones may be present. Standard and high power LA-306 models are 3-zone furnaces. Initially, temperature profiles must be recorded from temperatures measured inside the furnace.

9.4.2 Profile Specification

In general, the temperature profile is defined by a combination of the following parameters:

- a. Heating Rate: The rate of increase of temperature from room temperature.
- b. Dwell/Hold Time: The time the product remains above a certain temperature or range of temperatures.
- c. Second Heating Rate: The rate of increase of temperature from the temperature reached during the hold time (if required).
- d. Second Hold Time: Dwell/Hold time for 2nd heating (if required).
- e. Peak Temperature: The maximum temperature reached with a +/- range and time at peak.
- f. Cooling Rate: The rate of decrease of temperature to a lower/critical temperature.
- g. Product Exit Temperature: As required.

If across the belt temperature distribution is a critical factor, use of three thermocouples attached in a similar fashion in the same line across the belt can reveal the temperature stratification during furnace processing.

If the parts are of great thickness as in a brass forging part, two thermocouples can be used to measure the temperature differences at different locations on the sample part.

For production work, the required specification must be achievable at a single speed setpoint within the specified furnace speed range. In general, the speed range depends on the factory gearing for the size and type of furnace and the specified requirements. Many sets of belt speeds and temperature settings can meet a given set of profile specifications. Furthermore, higher belt speeds can result in greater temperature deviations and lower consistency from the desired temperature profile. Also higher speeds shorten the cooling retention time and the parts may exit the furnace too hot.

9.4.3 Basic Profiling Variables

The two most influential and basic variables in setting up a temperature profile are:

- Retention Time: The time required to pass through the process section. Retention time is influenced by belt speed and zone temperature setpoints.
- Temperature Setpoints: Determines the energy level in each zone.

The combination of the time-temperature exposure of the product determines the temperature profile. The temperature settings in each zone set the heating rate and hold times of the product.

A third and less influential factor in the temperature profile is:

- Flow Meter Settings: Controls the rate of gas flow through the process section. Can influence heating and cooling rates and furnace IR stability.

If the furnace is equipped for a controlled atmosphere, this will be an important factor to consider. Gas flow and flow meter settings are addressed in detail in Sections 8.1.3 and 8.1.4.

9.4.4 Types of Profiles

In most processes, two kinds of temperature profiles exist:

Equilibrium (flat) profile applications:

- Annealing
- Brazing
- Die-attachment processes
- Drying/Curing of polymeric products
- Glass or metal/solder sealing of IC packages
- Hybrid thick film and PTF firing

Non-Equilibrium (peaked/spiked) profile applications:

- Cerdip lead-frame attachment
- Solar cell firing processes
- Solder reflow attachment

Most microelectronic and semiconductor thermal processes fall into one of the above categories, or some combination of the two. Set the furnace parameters according to the type of process that will be used with the furnace.

Examples of the two fundamental types of profiles are illustrated in Figure 9-3 and Figure 9-4.

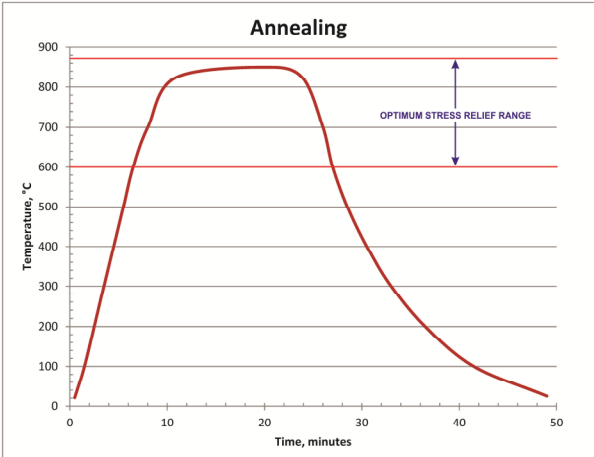

Figure 9-3 Equilibrium Profile

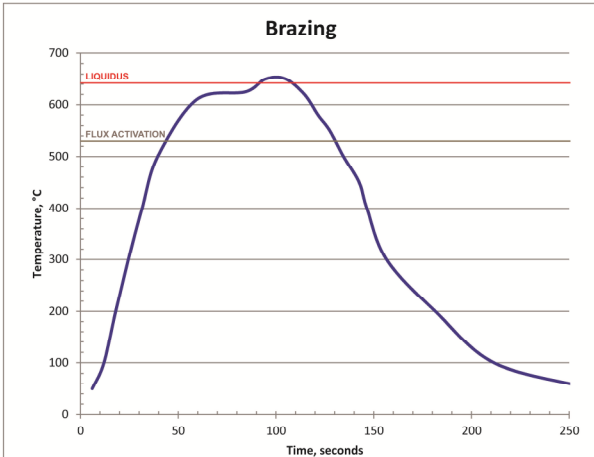

Figure 9-4 Non-equilibrium profile

9.4.5 Profiling Apparatus

A typical setup for profiling an LA-306 infrared furnace is depicted in Figure 9-5 and includes a computer and data logger positioned at the entrance of the furnace. For profiling, a type K thermocouple is placed on the surface of a part or representative sample which can be placed on the belt or in a parts boat. The thermocouple is plugged into a data logger connected to the computer. Figure 9-6 shows a close-up of a high speed high temperature type K thermocouple, a wire basket or parts boat, and a DataPaq Q18 data logger. As the part travels through the furnace, the computer graphs the temperature as a function of time and distance traveled.

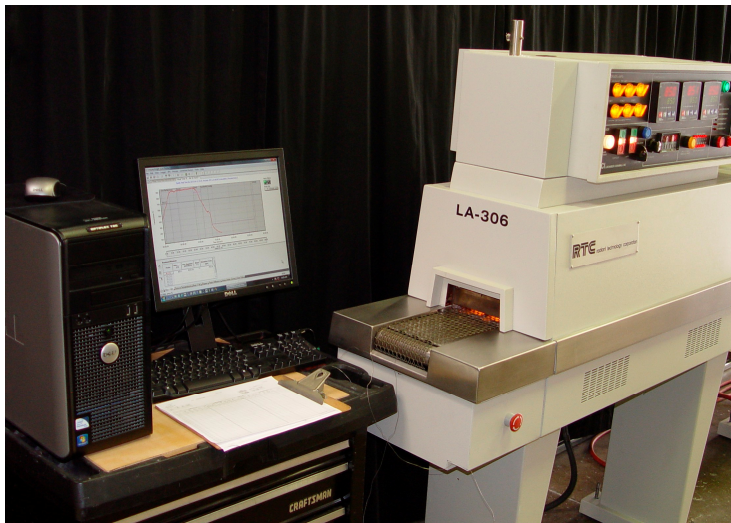

Figure 9-5 Temperature Profiling Apparatus

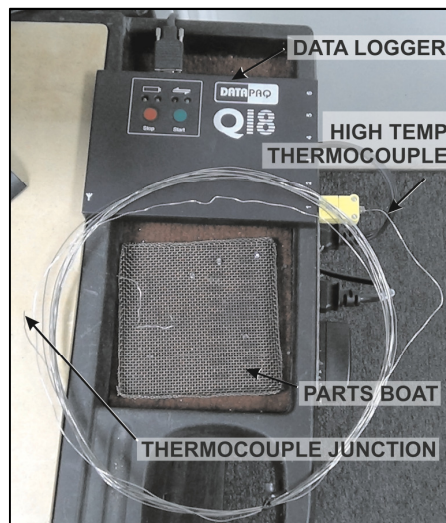

Figure 9-6 Data Logger

To produce a temperature profile, the following components are needed:

- Thermocouple
- Data Logger
- Sample part
- Computer

A. Thermocouple Wires

- K-Type thermocouples are recommended.

Depending upon operational temperatures, use a properly rated thermocouple for accurate readings. For temperatures above 300°C, we recommend the use of ultra-thin high speed type K thermocouples. Make sure exterior sheath is grounded to furnace frame.

Use one thermocouple for centerline profiling or three for across-the-belt profiling.

B. Data Loggers

A data logger or temperature data collection device. Examples are:

- Chart recorder
- DATAPAQ data logger (Q18 or similar)
- KIC temperature profiling kit
- MOLE/SuperMOLE data logger

Figure 9-6 shows a DataPaq Q18 six-channel data logger with one high temperature thermocouple attached to channel 1.

Another data collection method involves sending a data logger down the belt inside an insulated enclosure. A short thermocouple is connected to the data logger through a sealed opening in the enclosure. The data logger collects the data for later transfer to a computer for graphing and analysis.

C. Sample Part

The part can be an actual production part, or something of similar material, mass, size and shape. The closer the sample is to an actual production part, the more representative the results will be. If parts boats or carriers are to be used in production, use a similar boat for the test. Figure 9-7 and Figure 9-8 depict different samples with high temperature thermocouples in position.

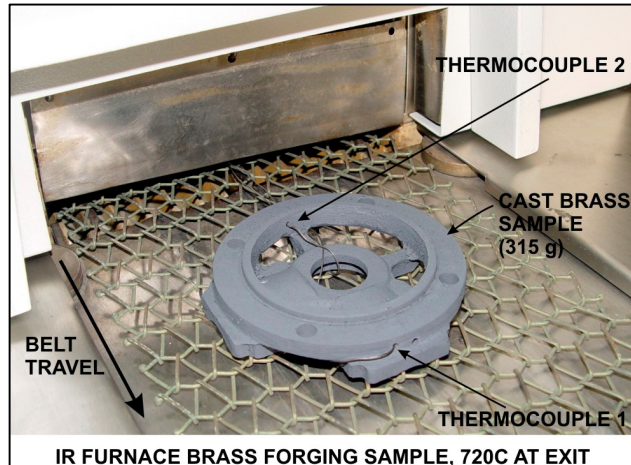

Figure 9-7 Brass Forging Sample With 2 thermocouples

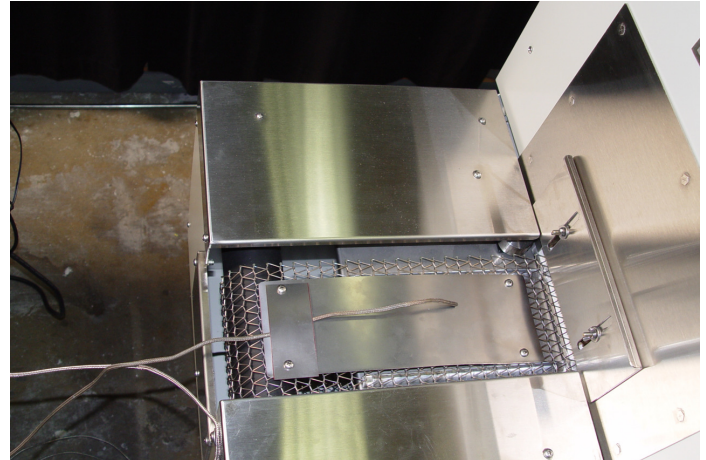

Figure 9-8 Metal Plate Sample with Wire Sheath Type K Thermocouple

9.4.6 Profiling Procedure

A. Operate furnace to steady state or READY.

B. Connect the thermocouple to the part and place on Load table.

1. Below temperatures of 300°C, the thermocouple can be taped with Kapton tape to a test specimen. Repeat testing may require new tape for accurate results.
2. Above 300°C, the thermocouple sensor can be cemented onto a test specimen if direct contact is not otherwise possible. In cases where the product of interest is not readily available, the thermocouple may be placed inside a small length of ceramic tube called a bead or other piece of material similar in shape and mass to the actual product.

C. For real time viewing, ready profiling software on the computer.

D. Place sample on belt. As thermocouple junction in the part passes furnace entrance, start data logger (click on start button on computer screen).

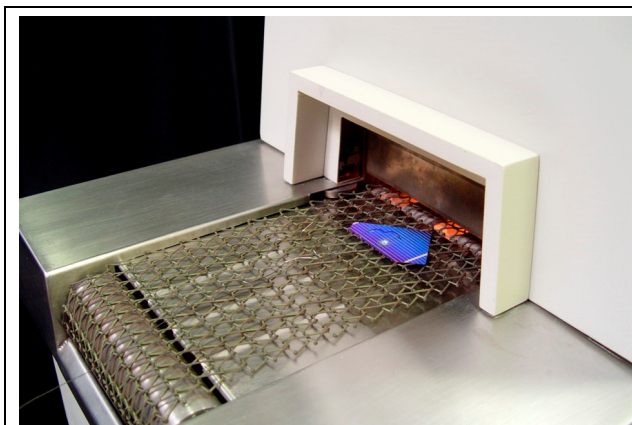

Figure 9-9 Silicon Wafer Entering Furnace

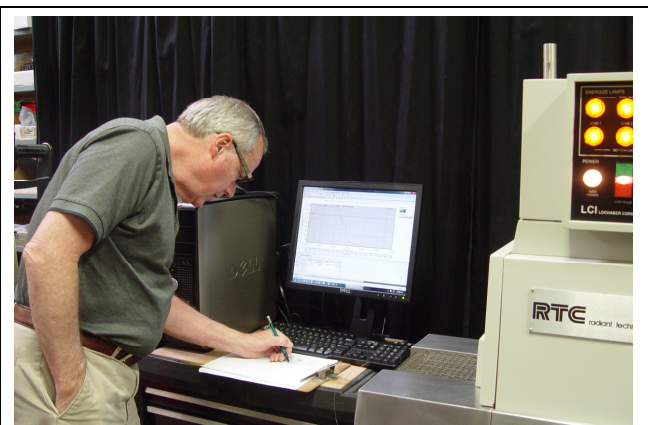

Figure 9-10 Recording Setpoints

Chapter 9

- E. Place sample on belt. As part passes furnace entrance (Figure 9-9), start data logger.
- F. Record temperature setpoints and process gas flowmeter setpoints in a log (Figure 9-10)
- G. As thermocouple junction passes exit of furnace, stop data logger.

Note: If the start and the stop times coincide with the furnace entrance and exit, the actual belt speed can be verified in the profiling software and graph.



Figure 9-11 Brass forging sample exiting furnace

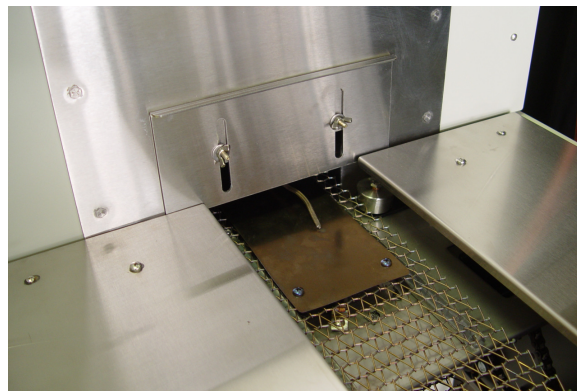

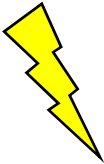
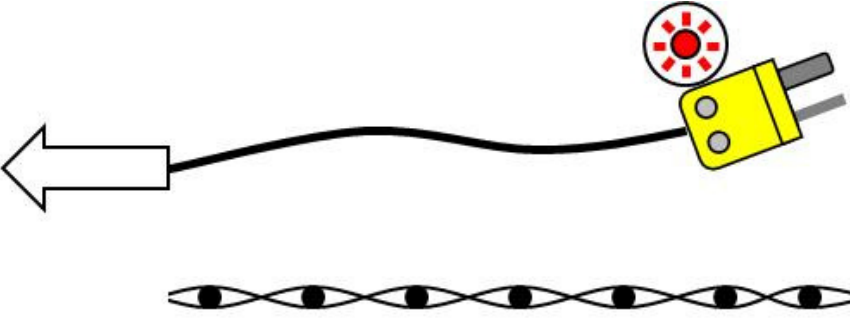

Figure 9-12 Sample plate exiting furnace

9.4.7 Safety Tips

	<p>DANGER: When using metal shielded thermocouple wires inside a furnace, electrostatic energy may collect on the wires. Properly ground the shielding material to the furnace chamber by wrapping a wire around the sheath and attaching one end to an unpainted portion of the furnace cabinet</p>
<p>DANGER:</p> 	<p>Extreme caution must be taken when pulling thermocouple wires through the process section. Connectors may bounce inside the chamber and break a lamp exposing the handler to high voltage and current, which could cause serious injury or death.</p> 

9.4.8 Equilibrium Profile Settings

For equilibrium profiles (flat temperatures profiles), set a belt speed that will result in at least a 6-10 minute dwell time inside the heating chamber. The following table shows some belt speeds for various heating chamber lengths.

Heating Chamber Length		Dwell Time			
(inches)	(cm)	6 minutes		10 minutes	
		(in./min)	(cm/min)	(in./min)	(cm/min)
30	76	5	12.7	3	7.6
60	152	10	25.4	6	15.2
90	229	15	38.1	9	22.9
120	304	20	50.8	12	30.4

For across-the-belt temperature profiles, set the belt speed to a minimum. The slow rate of the conveyor belt will result in a larger number of recorded temperature readings. A slower rate increases the resolution of the temperature profile and can reveal more information about temperature uniformity and consistency.

Set all zone temperatures to the desired peak temperature plus 5°C.

If edge heaters are installed, a setpoint of 30% power is a good starting point. Also, for edge heat, allow a few minutes to pass between setting adjustments, as the nickel chromium edge heat wires do not respond as quickly as the IR heat lamps.

If faster heating rate is desired with a longer dwell time at the peak temperature, increase the first 1-2 zone temperature setpoints by about 10-20% of the peak temperature. The heating rate will be higher at the start, while the remaining zones will maintain the temperature of the product at the peak temperature.

A slow belt speed will allow the temperature to reach the peak temperature within the first 1-2 zones. The rest of the heating chamber will hold the temperature for the remainder of the profile.

- Record the temperature and observe the results.

If the desired temperature and hold time is not achieved, begin tuning the belt speed and zone setpoint temperature variables. The following are some guidelines:

For faster initial heating rates, try one of the following:

- Lower the belt speed
- Raise the first 1-2 zone temperature setpoints

For slower initial heating rates:

- Raise the belt speed
- Lower the first 1-2 zone temperature setpoints

For faster belt speeds:

- Raise the belt speed 5%
- Increase zone 1-2 setpoint temperatures by 7%

For slower belt speeds:

- Lower the belt speed 5%
- Decrease zone 1-2 setpoint temperatures by 7%
- Record a new temperature profile

Go back and retune as necessary until the desired temperature profile is achieved.

9.4.9 Profiling Results – Typical Curves

Following are examples of actual LA-306 profiles run at the factory on different machines with product samples for a wide range of applications. Figures 9-13, 9-15 and 9-16 were performed on LCI LA-306 models. Figures 9-14, 9-17 and 9-18 were performed on LCI retrofitted RTC LA-306 furnaces.

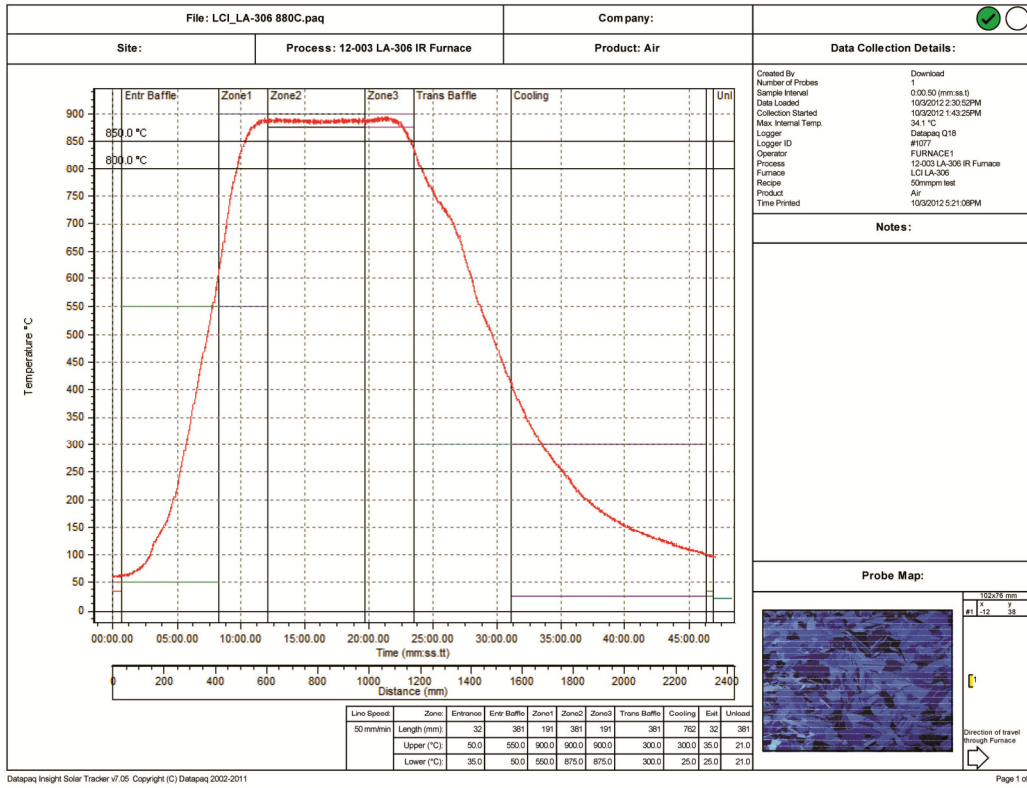

Figure 9-13 880 °C Annealing profile

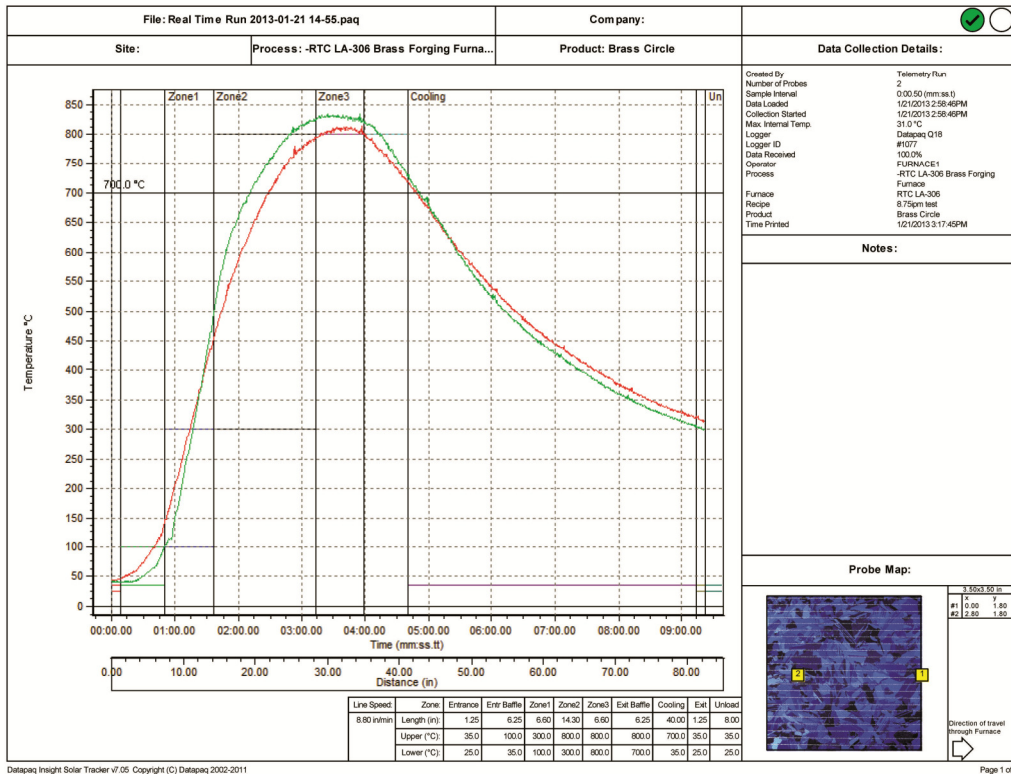

Figure 9-14 880 °C Brass Forging profile

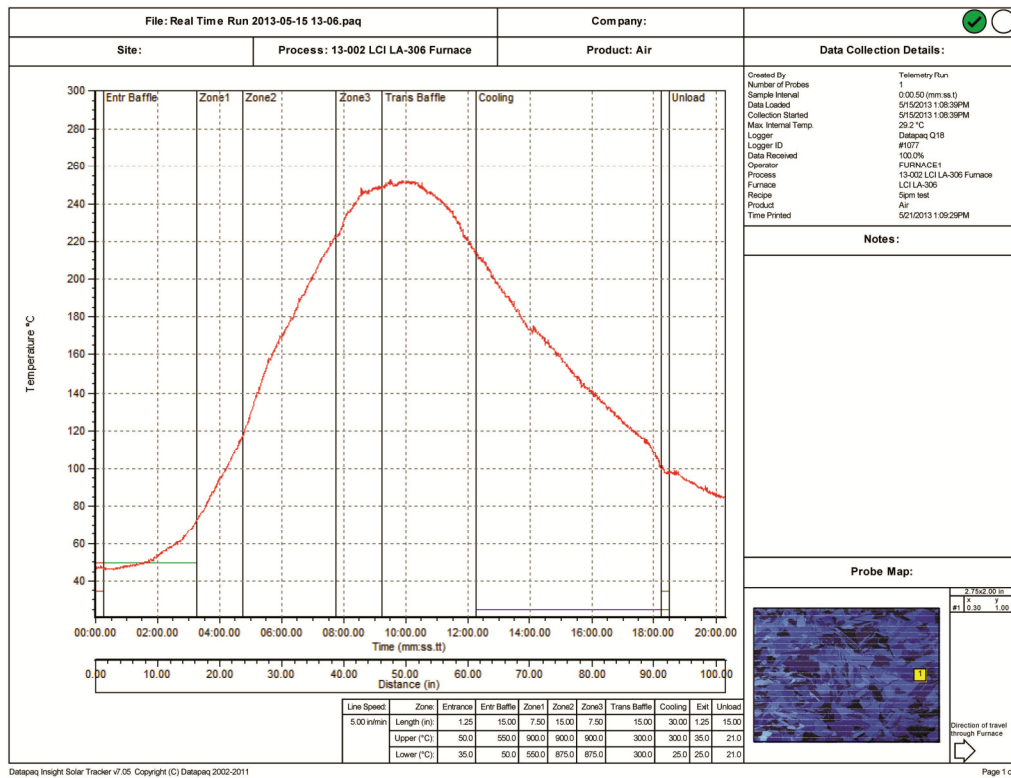

Figure 9-15 250 °C Curing Profile

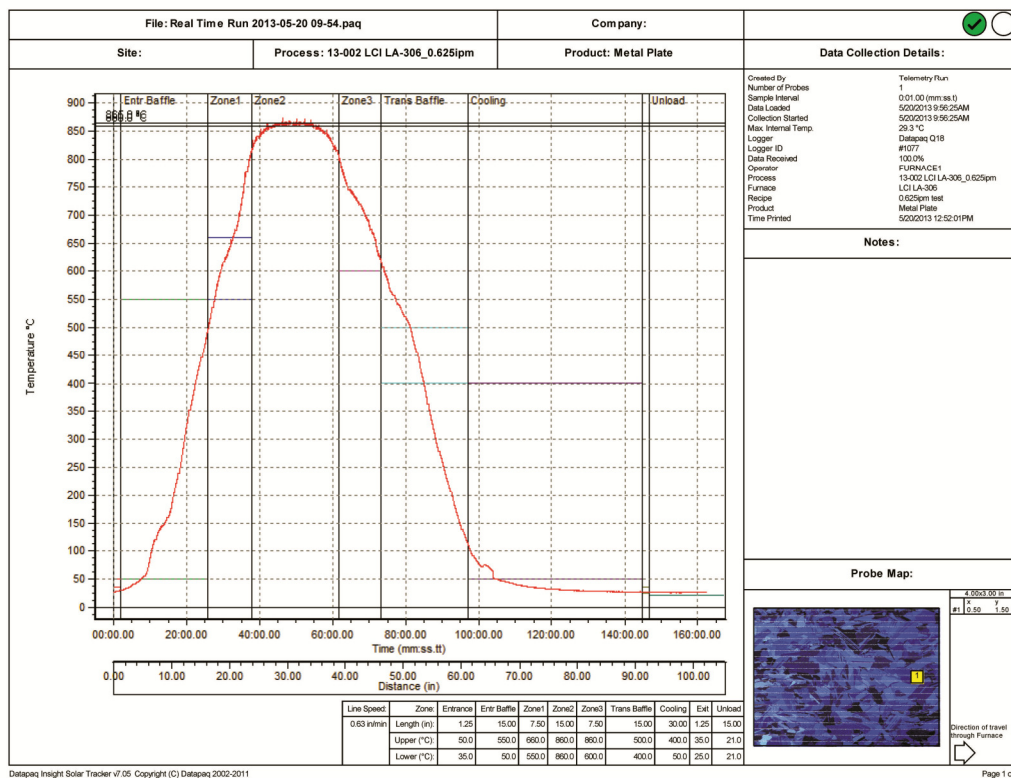

Figure 9-16 860 °C Thick Film profile

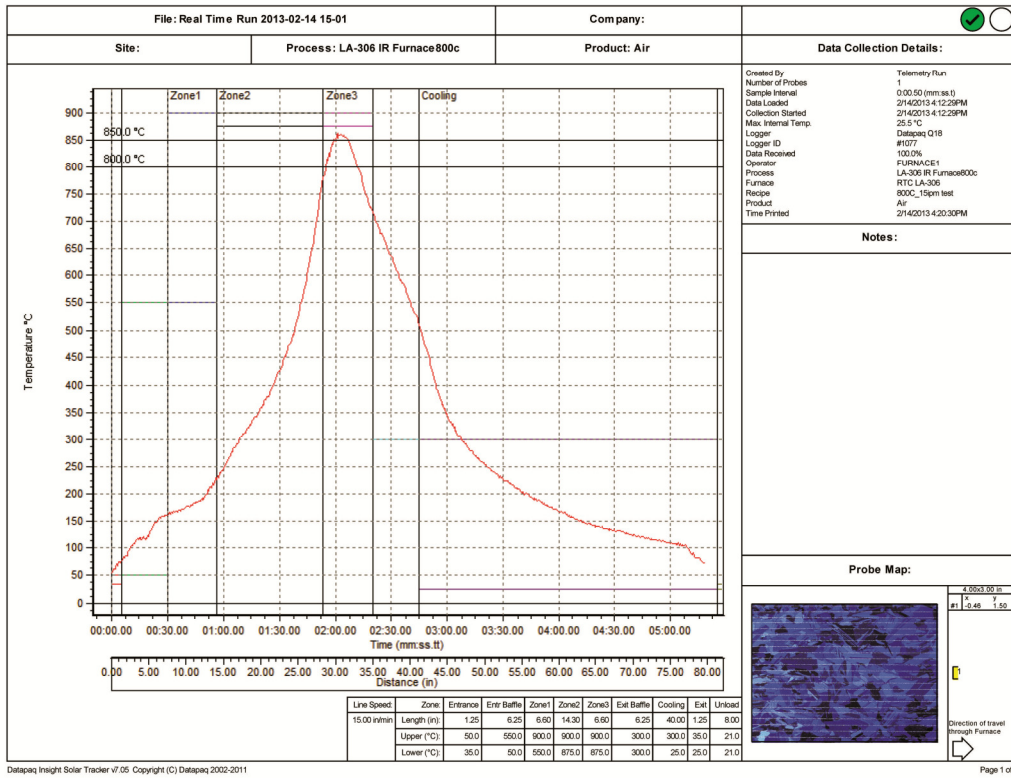

Figure 9-17 860 °C Spike profile

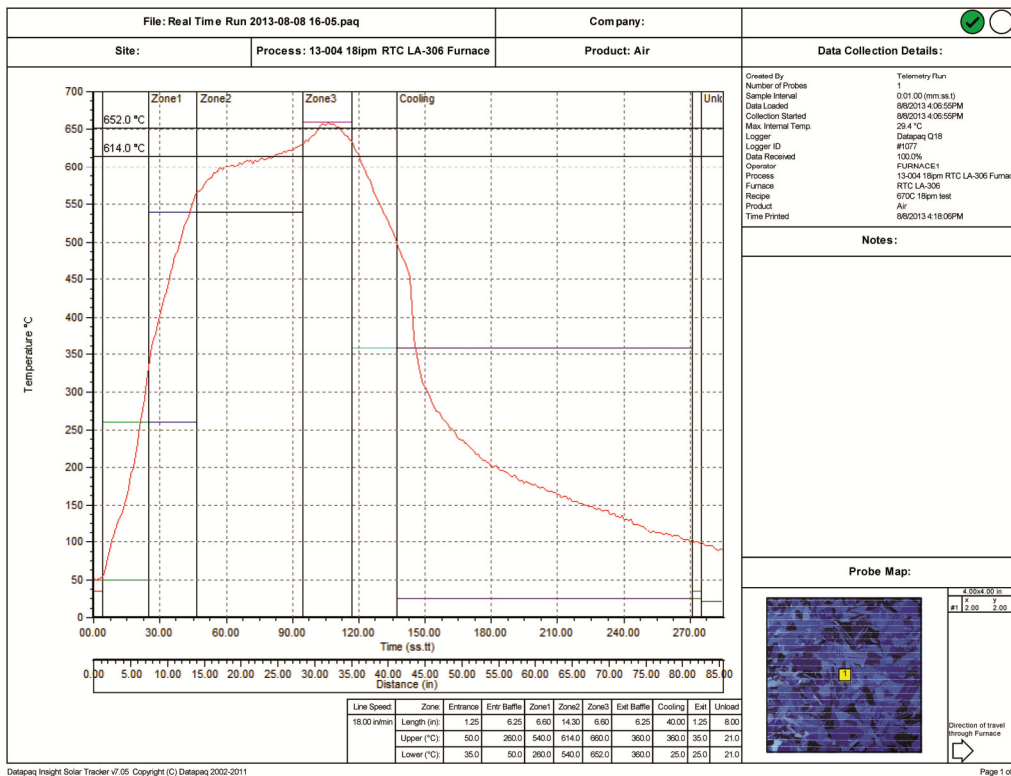
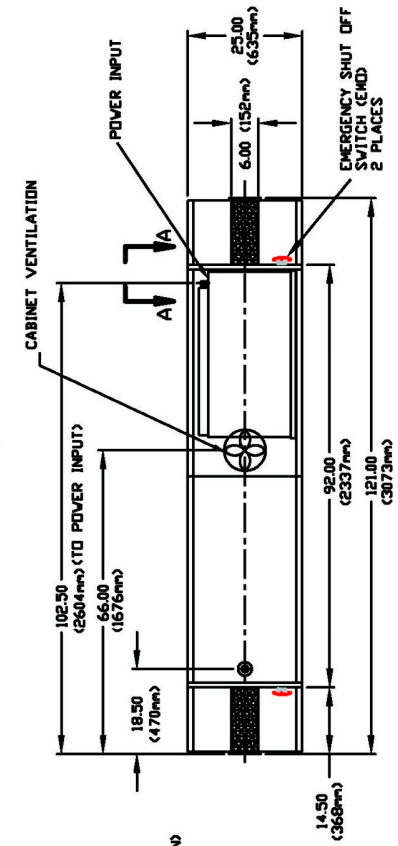

Figure 9-18 652 °C 1205 Brazing profile

DRAWINGS & SCHEMATICS

Job/Master	Drawing Nbr.	Title
STD	803-091306-01	FURNACE ARRANGEMENT, LA-306
STD	803-091306-05	FURNACE ARRANGEMENT, LA-306 with Options
STD	803-091734-01	CHAMBER ARRANGEMENT
STD	803-091734-02	CHAMBER ARRANGEMENT WITH IE
STD	801-090342-01	PROCESS GAS PLUMBING, SINGLE GAS
STD	801-090342-02	PROCESS GAS PLUMBING, DUAL GAS (option)
STD	801-091940-06	SUPPLY GAS MIXING SYSTEM (option)
STD	801-090776-05	ANALYZER GAS SAMPLE SYSTEM (option)
STD	802-101779-01	SAFETY PANEL LA-306 (208-240 VAC)
STD	802-101779-02	SAFETY PANEL LA-306 (380-415 VAC)
STD	802-101780-03	POWER CONTROL, PLC LA-306
STD	802-101781-04	FRAME WIRING SCHEMATIC, LA-306 & LA-309P
STD	802-101784-02	CONTROL CONSOLE, PLC LA-306
STD	802-101785-07	ZONE CONTROL PANEL (AFTER 2015)
STD	802-101814-306	ELEMENT WIRING – STANDARD POWER
STD	802-101814-306HP	ELEMENT WIRING – HIGH POWER
STD	802-101783	ANALYZER & OSS CONTROL (option)
STD	802-101950-02	PRODUCT ALERT (option)

REV	DESCRIPTION	DATE	APPROVED



PLAN VIEW

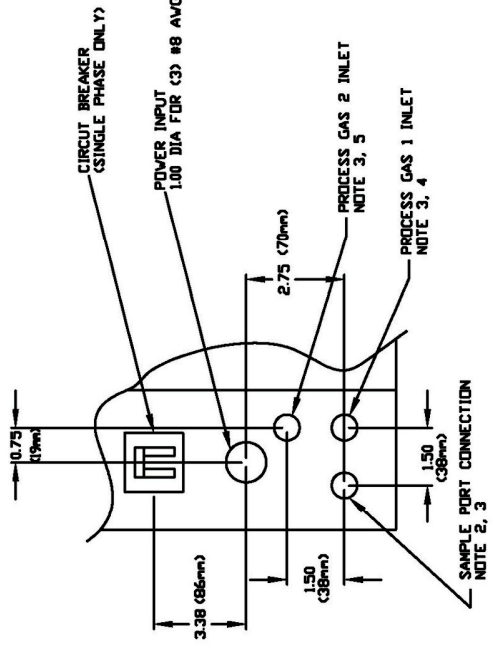

VIEW A-A

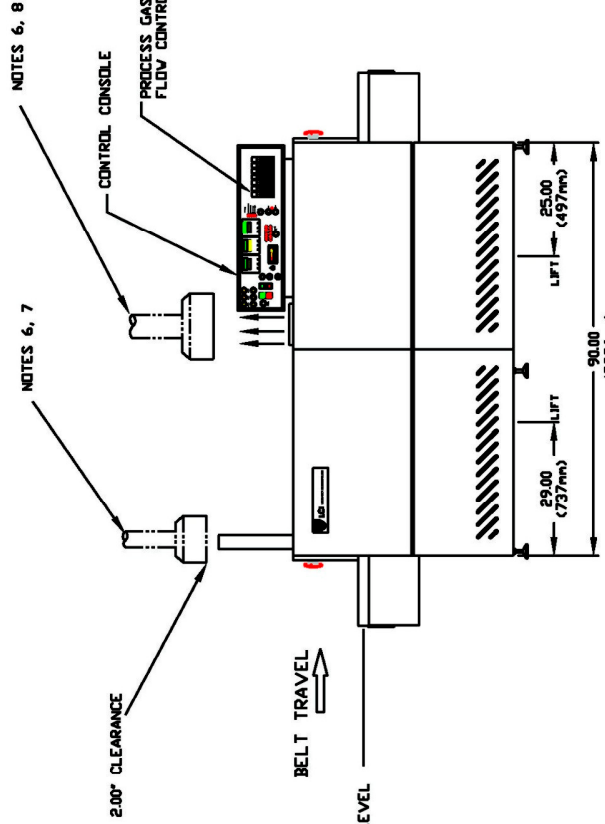

FRONT ELEVATION

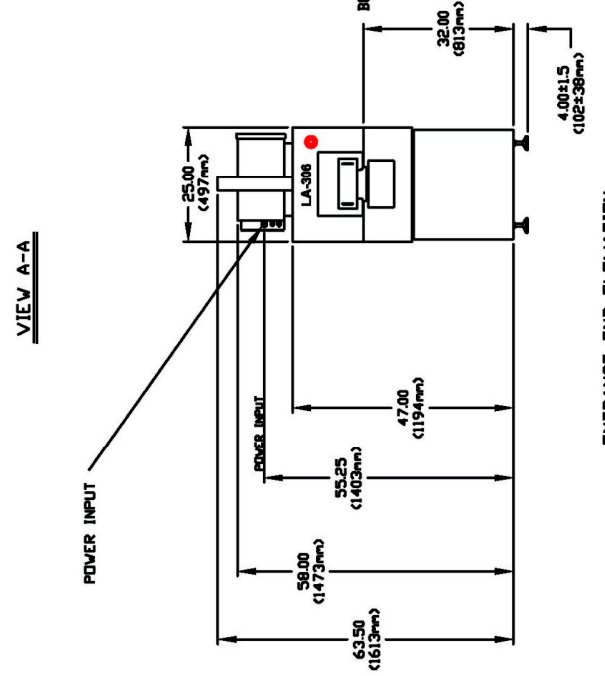

ENTRANCE END ELEVATION

NOTES:

1. FOR COMPLETE INSTALLATION INSTRUCTIONS CONSULT FURNACE OPERATING MANUAL.
2. OPTIONAL EQUIPMENT.
3. 1/4 FEMALE NPT.
4. CONNECT TO GAS 1 INLET: AIR (CDA) OR NITROGEN SUPPLY.
5. DUAL GAS OPTION: CONNECT TO GAS 2 INLET; FURNING GAS OR OTHER SPECIALTY GAS FOR HEATING ZONES.
6. BY OTHERS.
7. RECOMMENDED PROCESS GAS EXHAUST 4.0 DIA INSULATED DUCT WITH 8.0 DIA RECTANGULAR HOOD FOR 250L / MIN @ 60C.
8. OPTIONAL CABINET VENTILATION 4.0 DIA DUCT WITH 8.0 X 12.0 RECTANGULAR HOOD FOR 250L / MIN @ 25C.

 DIVISION OF LOCHABER CORNWALL INC		MODEL NO LA-306
APPROVALS DESIGNER C. ROODE	DATE 3/8/73	TITLE FURNACE ARRANGEMENT
CHECKED J. CLARK	DATE 3/8/73	SIZE STD
DRAWN J. CLARK	DATE 3/8/73	REV. NO 003-091306-01
DO NOT SCALE DRAWING		SHEET NO 1 OF 1

REVISONS		DATE	APPROVED
REV	DESCRIPTION		

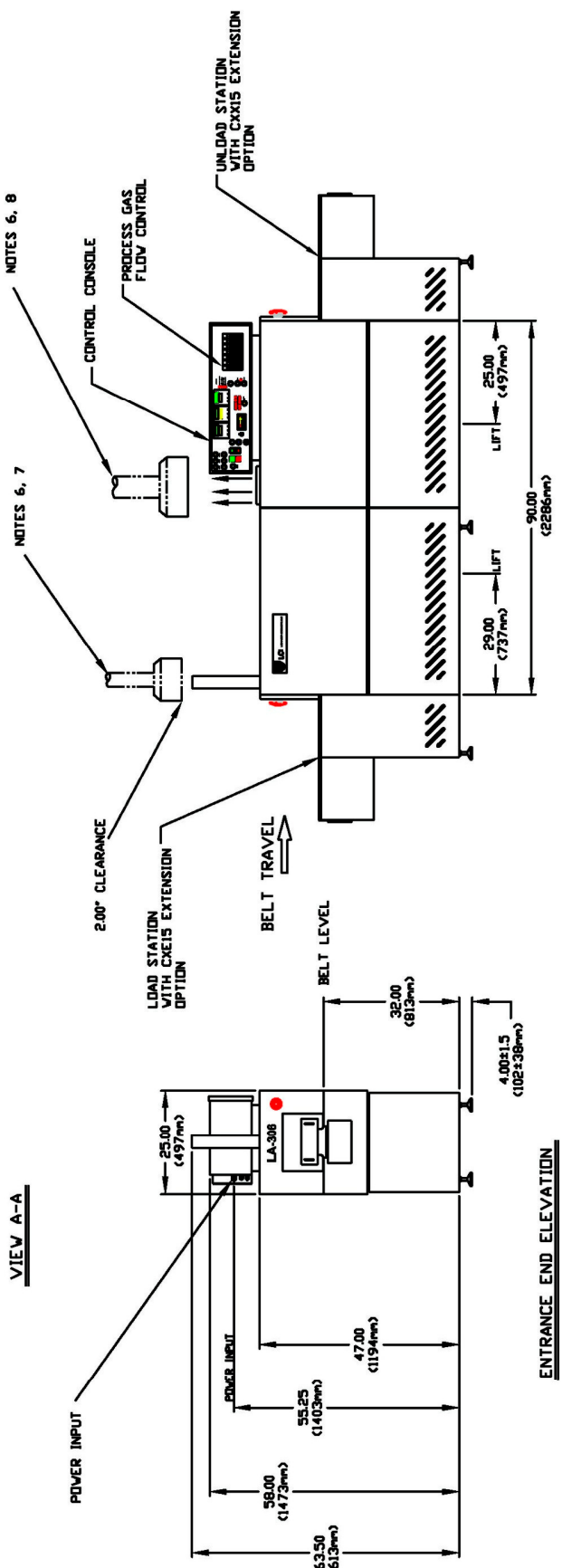
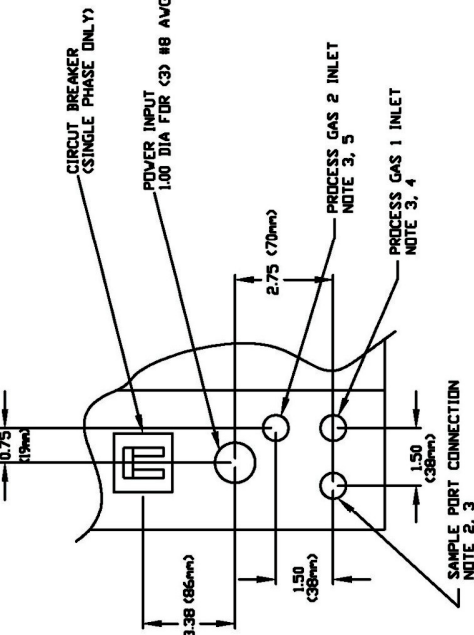
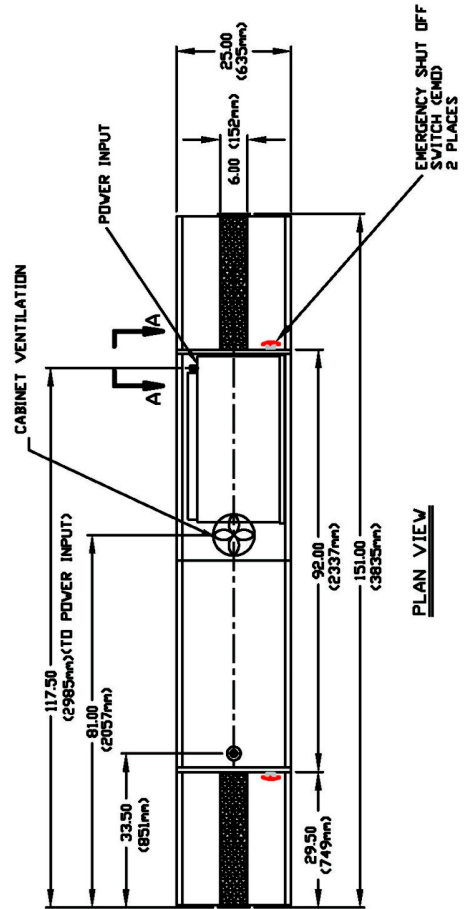

ENTRANCE END ELEVATION

- NOTES:**
1. FOR COMPLETE INSTALLATION INSTRUCTIONS CONSULT FURNACE OPERATING MANUAL.
 2. OPTIONAL EQUIPMENT.
 3. 1/4" FEMALE NPT.
 4. CONNECT TO GAS 1 INLET, AIR (CJIA) OR NITROGEN SUPPLY.
 5. DUAL GAS OPTION, CONNECT TO GAS 2 INLET, FORMING GAS OR OTHER SPECIALTY GAS FOR HEATING ZONES.
 6. BY OTHERS.
 7. RECOMMENDED PROCESS GAS EXHAUST 4.0 DIA INSULATED DUCT WITH 8.0 DIA COLLECTOR HOOD FOR MAX 150L/MIN @ 60C.
 8. OPTIONAL CABINET VENTILATION 4.0 DIA DUCT WITH 80 X 120 RECTANGULAR HOOD FOR 250L / MIN @ 25C.

<p>LCI Furnaces DIVISION OF LOCHNER CORNWALL INC</p>		<p>SCALE: NONE</p> <p>BUCK 1 OF 1</p>
<p>UNLESS OTHERWISE SPECIFIED DIMENSIONS ARE IN INCHES (METRIC DIMENSIONS ARE IN PARENTHESES)</p>	<p>MODEL NO LA-306 EXTENDED</p>	<p>DATE 2/9/73</p>
<p>PROPRIETARY AND CONFIDENTIAL THE INFORMATION CONTAINED IN THIS DRAWING IS THE SOLE PROPERTY OF LOCHNER CORNWALL, INC. ANY REPRODUCTION IN PART OR AS A WHOLE WITHOUT THE WRITTEN PERMISSION OF LOCHNER CORNWALL, INC. IS PROHIBITED.</p>	<p>APPROVALS</p> <p>DESIGNER J. CLARK</p> <p>CHECKER J. CLARK</p> <p>DATE 2/9/73</p>	<p>TITLE FURNACE ARRANGEMENT</p> <p>SIZE CONTRACT STD</p> <p>REV. -</p>
<p>DO NOT SCALE DRAWING</p>		

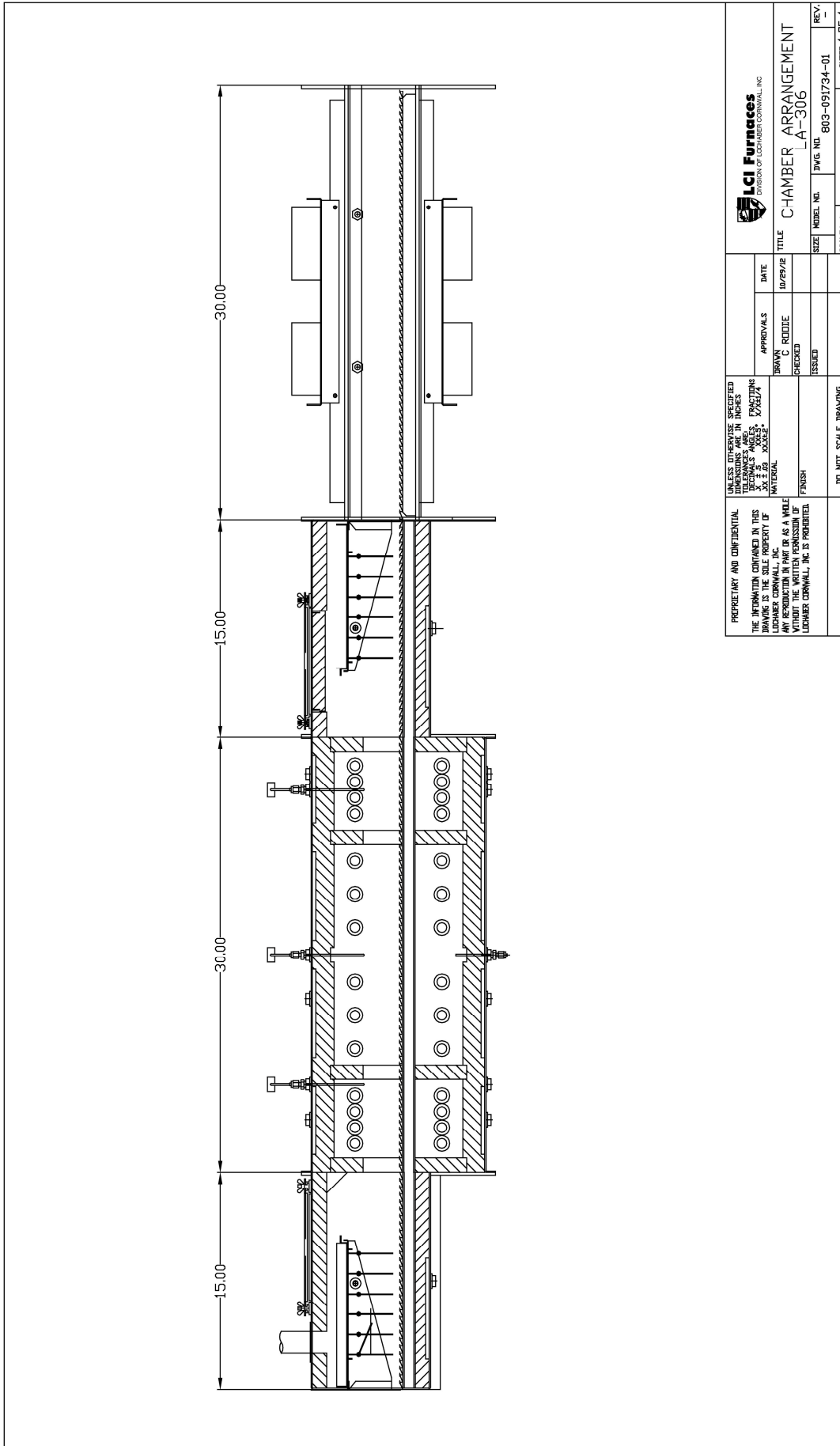

<p>LCI Furnaces DIVISION OF LOCHNER CORNWALL, INC.</p>		<p>DATE 10/29/12</p>	
<p>UNLESS OTHERWISE SPECIFIED DIMENSIONS ARE IN INCHES DECIMALS ANGLES FRACTIONS XX.XX XX.XX.XX XX.XX.XX MATERIAL FINISH</p>		<p>APPROVALS DRAWN C CHECKED ISSUED</p>	
<p>PROPRIETARY AND CONFIDENTIAL THE INFORMATION CONTAINED IN THIS DRAWING IS THE SOLE PROPERTY OF LOCHNER CORNWALL, INC. ANY REPRODUCTION IN PART OR AS A WHOLE WITHOUT THE WRITTEN PERMISSION OF LOCHNER CORNWALL, INC. IS PROHIBITED.</p>		<p>TITLE CHAMBER ARRANGEMENT LA-306</p>	
<p>DO NOT SCALE DRAWING</p>		<p>SIZE MODEL NO. 803-091734-01</p>	<p>SCALE NONE REV. 1 SHEET 1 OF 1</p>

10.4 Furnace Chamber, Intermediate Exhaust

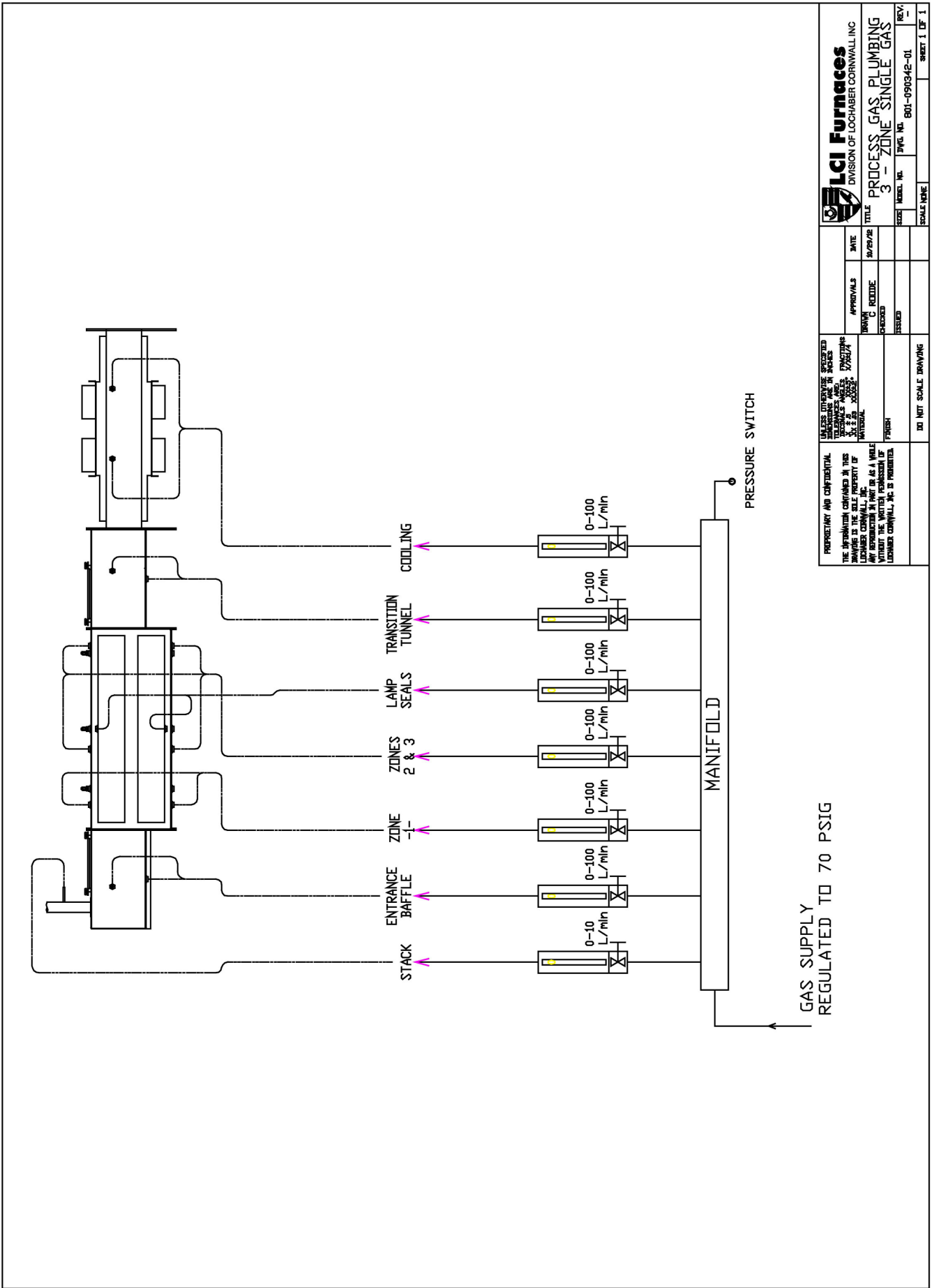

PROPRIETARY AND CONFIDENTIAL THE INFORMATION CONTAINED IN THIS DRAWING IS THE SOLE PROPERTY OF LOCHABER CORNWALL, INC. ANY REPRODUCTION IN PART OR AS A WHOLE WITHOUT THE WRITTEN PERMISSION OF LOCHABER CORNWALL, INC. IS PROHIBITED.	UNLESS OTHERWISE SPECIFIED DIMENSIONS ARE IN INCHES DECIMALS ARE TO 0.0005" DIMENSIONS IN PARENT SQUARES ARE TO 0.005"		APPROVALS DATE 04/29/06	LCI Furnaces DIVISION OF LOCHABER CORNWALL, INC.
	FINISH		CHECKED DESIGNED	TITLE PROCESS GAS PLUMBING 3 - ZONE SINGLE GAS
DO NOT SCALE DRAWING		MODEL NO.	DWG. NO. 801-090342-01	REV.
SCALE		SHEET 1 OF 1		

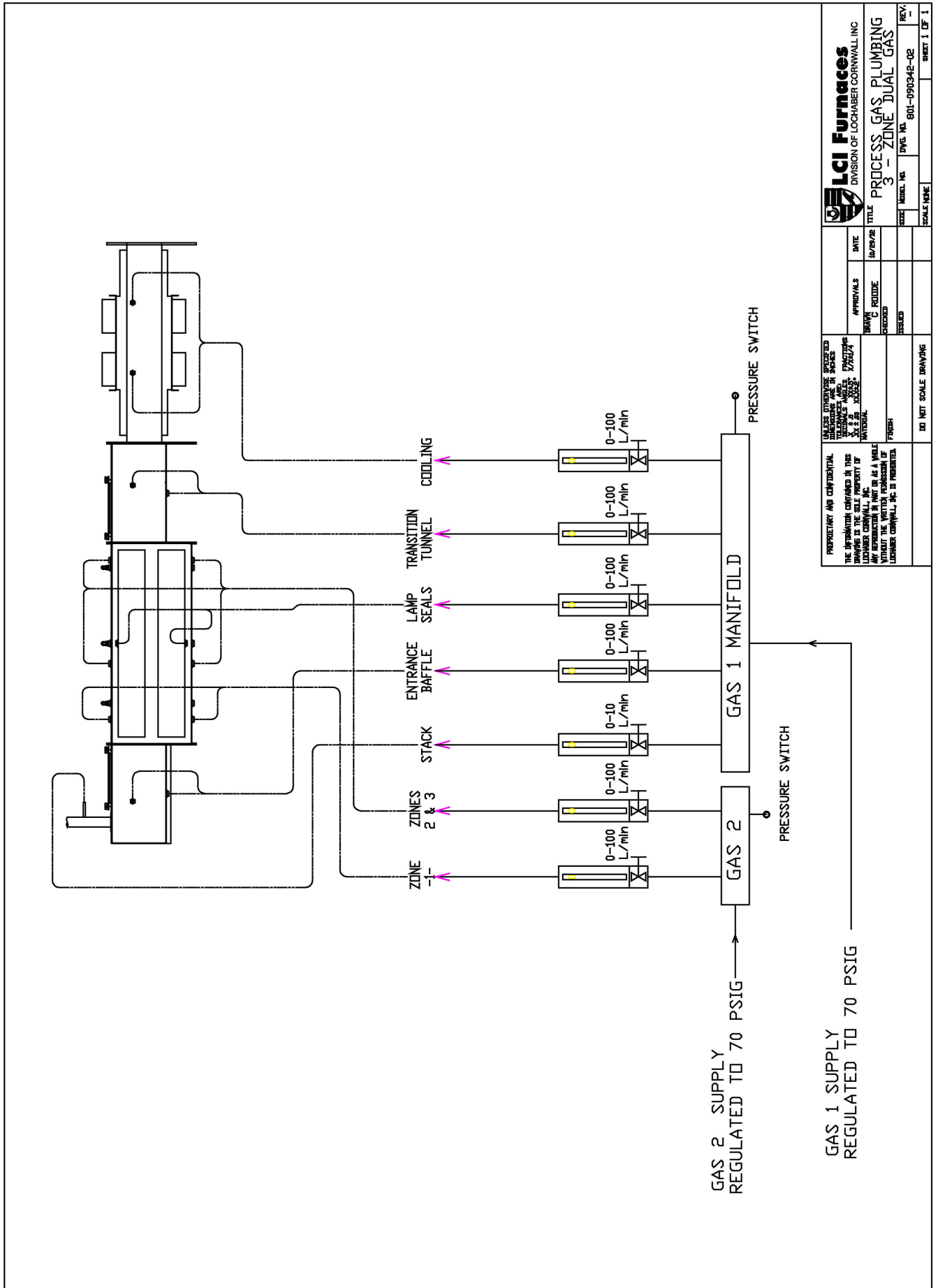

PROPRIETARY AND CONFIDENTIAL THE INFORMATION CONTAINED IN THIS DRAWING IS THE PROPERTY OF LOCHABER CORNWALL, INC. ANY REPRODUCTION IN PART OR AS A WHOLE WITHOUT THE WRITTEN PERMISSION OF LOCHABER CORNWALL, INC. IS PROHIBITED.	THESE DIMENSIONS ARE UNLESS OTHERWISE SPECIFIED IN BRACKETS DECIMALS AND FRACTIONS 3/16 3/8 1/2 5/8 3/4	APPROVALS DATE 10/29/98	LCI Furnaces DIVISION OF LOCHABER CORNWALL, INC.
	TITLE PROCESS GAS PLUMBING 3 - ZONE DUAL GAS	CHECKED ISSUED	SCALE NONE
DESIGNER DRAWN C. REIDIE	CHECKED ISSUED	DATE	TITLE PROCESS GAS PLUMBING 3 - ZONE DUAL GAS
PROJECT NO.	DRAWING NO. 801-090342-02	SCALE NONE	SHEET 1 OF 1
DO NOT SCALE DRAWING	PROJECT NO.	DRAWING NO.	TITLE

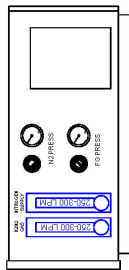

CONTROL ENCLOSURE - ELEVATION VIEW FROM FURNACE EXIT

- ← FACILITY POWER CONNECTION
- ← PORT 1. GAS 1 SUPPLY CONN (CDA, N2, OR OTHER, REF GAS COMBINATIONS TABLE)
- ← PORT 2. GAS 2 SUPPLY CONN (NG, FG, OTHER, OR NONE, REF GAS COMBINATIONS TABLE)

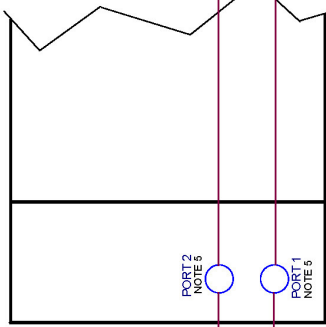

FURNACE CONTROL ENCLOSURE - REAR ELEVATION (REF)

- GAS2 SUPPLY: NITROGEN, FG OR SPECIALTY GASES FOR HEATING ZONES ONLY. NOTE 3, 4 & 6. SEE GAS COMBINATIONS TABLE
- GAS1 SUPPLY: CDA OR NITROGEN FOR AUX GAS MANIFOLD AND TO GAS1 FOR HEATING ZONES. NOTE 3, 4, 6 & 7. SEE GAS COMBINATIONS TABLE

INSTALLATION & SETUP NOTES - SINGLE GAS OPERATION:

- CONNECT GAS1 SUPPLY LINE TO PORT 1 TO SUPPLY GAS TO ALL FLOWMETERS.
- GAS1 IS ONLY SUPPLIED TO HEATING ZONES WHEN FLOWMETER FIC1 IS OPEN.
- ADJUST PRESSURE REGULATOR VPR1 TO 4.8 BAR (70 PSIG).
- OPEN FLOWMETER FIC1 AND CLOSE FIC2.

INSTALLATION & SETUP NOTES - DUAL GAS OPERATION:

- CONNECT GAS1 SUPPLY LINE TO PORT 1 TO PROVIDE GAS1 TO ALL FLOWMETERS. GAS1 IS ONLY SUPPLIED TO HEATING ZONES WHEN FLOWMETER FIC1 IS OPEN.
- CONNECT GAS2 SUPPLY LINE TO PORT 2 TO PROVIDE GAS2 TO HEATING ZONES WHEN FLOWMETER FIC2 IS OPEN.
- ADJUST PRESSURE REGULATORS VPR1 AND VPR2 TO 4.8 BAR (70 PSIG).
- IF GAS1 ONLY IS TO BE USED IN THE HEATING ZONES, OPEN FLOWMETER FIC1 AND CLOSE FIC2.
- IF GAS 2 ONLY IS TO BE USED IN THE HEATING ZONES, OPEN FLOWMETER FIC2 AND CLOSE FIC1.
- IF GAS 2 (FG) IS TO BE FURTHER DILUTED WITH GAS 1 (N2), OPEN BOTH FIC1 AND FIC2 TO PROPORTIONATE LEVELS DESIRED. (YOU MAY HAVE TO OPEN GAS FLOW CONTROL ZONE 1 AND ZONE 2&3 FLOWMETERS FULL OPEN INITIALLY TO GET ENOUGH FLOW TO BALANCE THE TWO SUPPLY GASES, THEN RESET ZONE FLOWMETERS TO RECIPRE SETTINGS)

NOTES:

- INCLUDED IN SUPPLY GAS MIXING OPTION.
- RECOMMENDED TO BE SUPPLIED BY OWNER.
- ALL PIPING AND TUBING OUTSIDE ENCLOSURES ARE BY OTHERS.
- CUSTOMER SHALL ASSURE SUPPLY GAS AND SYSTEM MEETS ALL SAFETY REQUIREMENTS INCLUDING MAXIMUM ALLOWABLE COMBUSTIBLE CONCENTRATION IN SUPPLY GAS FOR SAFE LFL (LOWER FLAMMABLE LIMIT) AND LEL (LOWER EXPLOSIVE LIMIT).
- INCLUDED WITH DUAL GAS OPTION.
- HEATING ZONE MANIFOLD CONNECTS TO GAS FLOW CONTROL FLOWMETERS FOR ZONE 1 AND ZONES 2,3.
- AUX GAS MANIFOLD CONNECTS TO GAS FLOW CONTROL FLOWMETERS FOR ENTR BAFFLE, TRANS BAFFLE, STACK, LAMP SEALS AND COOLING.
- PROVIDES CDA, N2 OR FG GAS PRESSURE LOW SIGNAL.

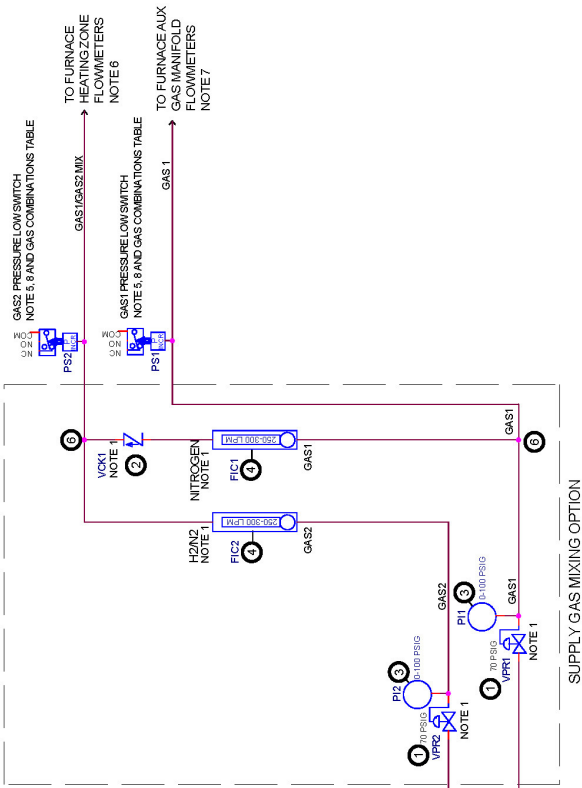

SUPPLY GAS MIXING OPTION

DEFINITIONS:

- CDA=CLEAN DRY AIR
- H2=HYDROGEN
- N2=NITROGEN
- FG=FORMING GAS (N2/H2 MIX)

GAS COMBINATIONS TABLE:

- GAS1=CDA, GAS2=N2 or none
- GAS1=N2, GAS 2=FG or none
- GAS1=Argon or other inert gas, GAS2=FG or other non combustible reducing gas or none.

IF GAS1 and GAS2 are the same gas, use SINGLE GAS INSTALLATION AND SETUP S1-S3.

WARNING:

DO NOT CONNECT PURE HYDROGEN OR OTHER COMBUSTIBLE GAS TO EITHER PORT OF THIS FURNACE.

REV	DESCRIPTION	DATE	APPROVED	DATE	APPROVED	REVISION	DATE	APPROVED	DATE	APPROVED	
1	ADDED INSTALLATION NOTES, DEFINITIONS, GAS COMBINATIONS	01/17/2012	J CLARK	01/17/2012	J CLARK	1	09/06/2012	J CLARK	09/06/2012	J CLARK	
2						2	09/06/2012	S BARBER	09/06/2012	S BARBER	
3						3	09/06/2012	J CLARK	09/06/2012	J CLARK	
<p>ICl Furnaces DIVISION OF LOCKHEED CORNWALL, INC. 878 NORTH LEONHOF STREET, BLDG 2, ORANGE, CA 92688 USA</p>											
<p>REVISION: SUPPLY GAS MIXING SYSTEM</p>											
Doc Number	801-091940-06										
Sheet	1	of	3								

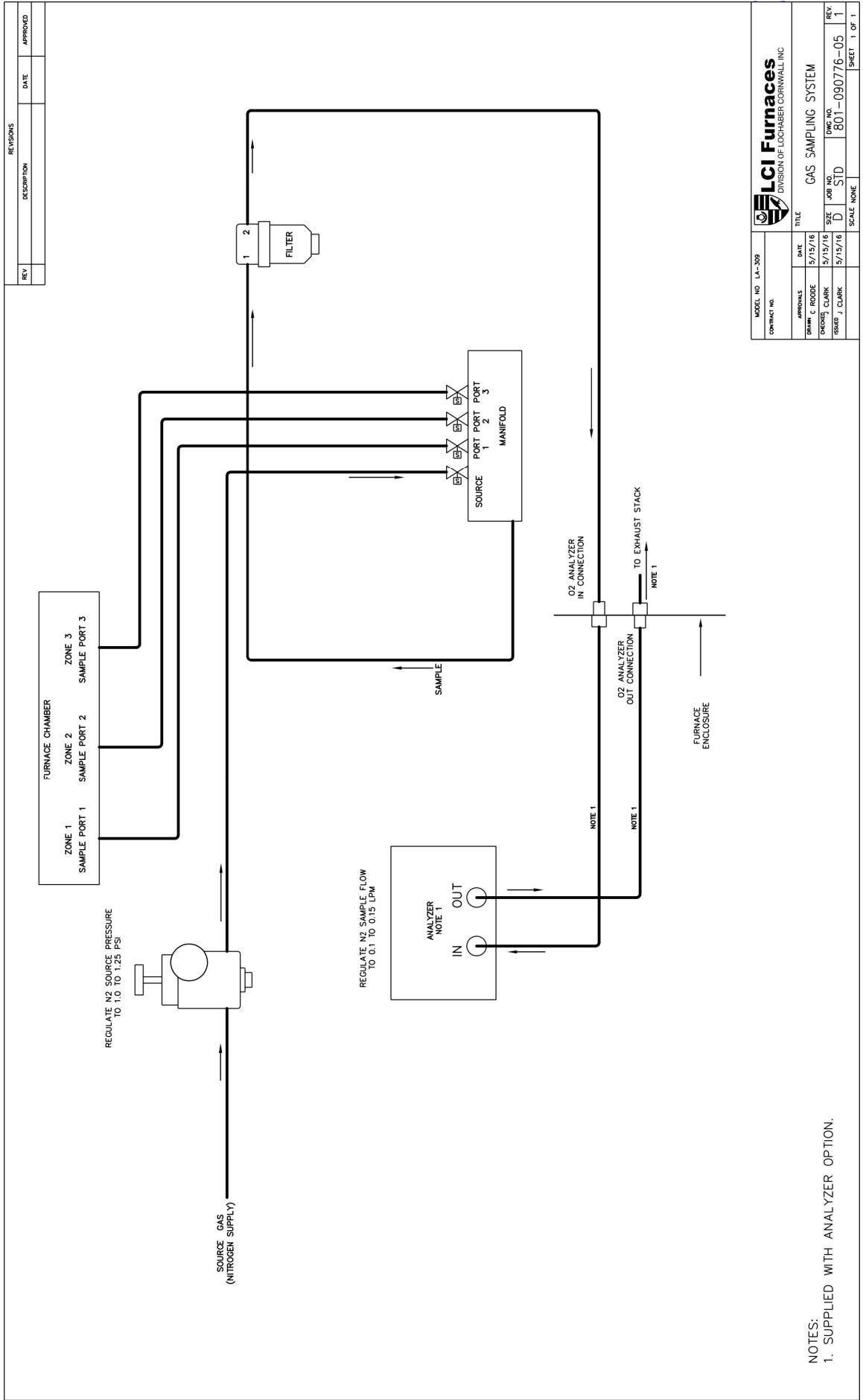

REV.	DESCRIPTION	DATE	APPROVED

REVISIONS

MODEL NO. LA-309	DATE	TITLE
CONTRACT NO.	5/15/16	GAS SAMPLING SYSTEM
APPROVAL	5/15/16	DIVISION OF LOCHABER CORNWALL, INC.
DRAWN: E. ROODE	5/15/16	SIZE
CHECKED: J. CLARK	5/15/16	D
ISSUED: J. CLARK	5/15/16	JOB NO.
		STD
		DWG. NO.
		801-090776-05
		REV.
		1
		SCALE
		NONE
		SHEET
		1 OF 1

NOTES:
1. SUPPLIED WITH ANALYZER OPTION.

LCI Furnaces
 DIVISION OF LOCHABER CORNWALL INC.
 675 NORTH ECKHOFF STREET, BLDG D, ORANGE, CA 92668 USA

REV.	DATE	ISSUED BY	APPROVED BY	DESCRIPTION
6	05/21/2013	J CLARK	J CLARK	REVISED TO ADD 24 VAC SUPPLY
5	05/21/2013	J CLARK	J CLARK	REVISED TO ADD 24 VAC SUPPLY
4	09/21/16	S BARBER	S BARBER	REVISED TO ADD 24 VAC SUPPLY
3	07/20/16	S BARBER	S BARBER	REVISED TO ADD 24 VAC SUPPLY
2	05/21/13	S BARBER	S BARBER	REVISED TO ADD 24 VAC SUPPLY
1	05/21/13	S BARBER	S BARBER	REVISED TO ADD 24 VAC SUPPLY

REV.	DATE	ISSUED BY	APPROVED BY	DESCRIPTION
6	05/21/2013	J CLARK	J CLARK	REVISED TO ADD 24 VAC SUPPLY
5	05/21/2013	J CLARK	J CLARK	REVISED TO ADD 24 VAC SUPPLY
4	09/21/16	S BARBER	S BARBER	REVISED TO ADD 24 VAC SUPPLY
3	07/20/16	S BARBER	S BARBER	REVISED TO ADD 24 VAC SUPPLY
2	05/21/13	S BARBER	S BARBER	REVISED TO ADD 24 VAC SUPPLY
1	05/21/13	S BARBER	S BARBER	REVISED TO ADD 24 VAC SUPPLY

SAFETY PANEL, LA-306 (208-240 Vac)
 PART NUMBER: 802-101779-01

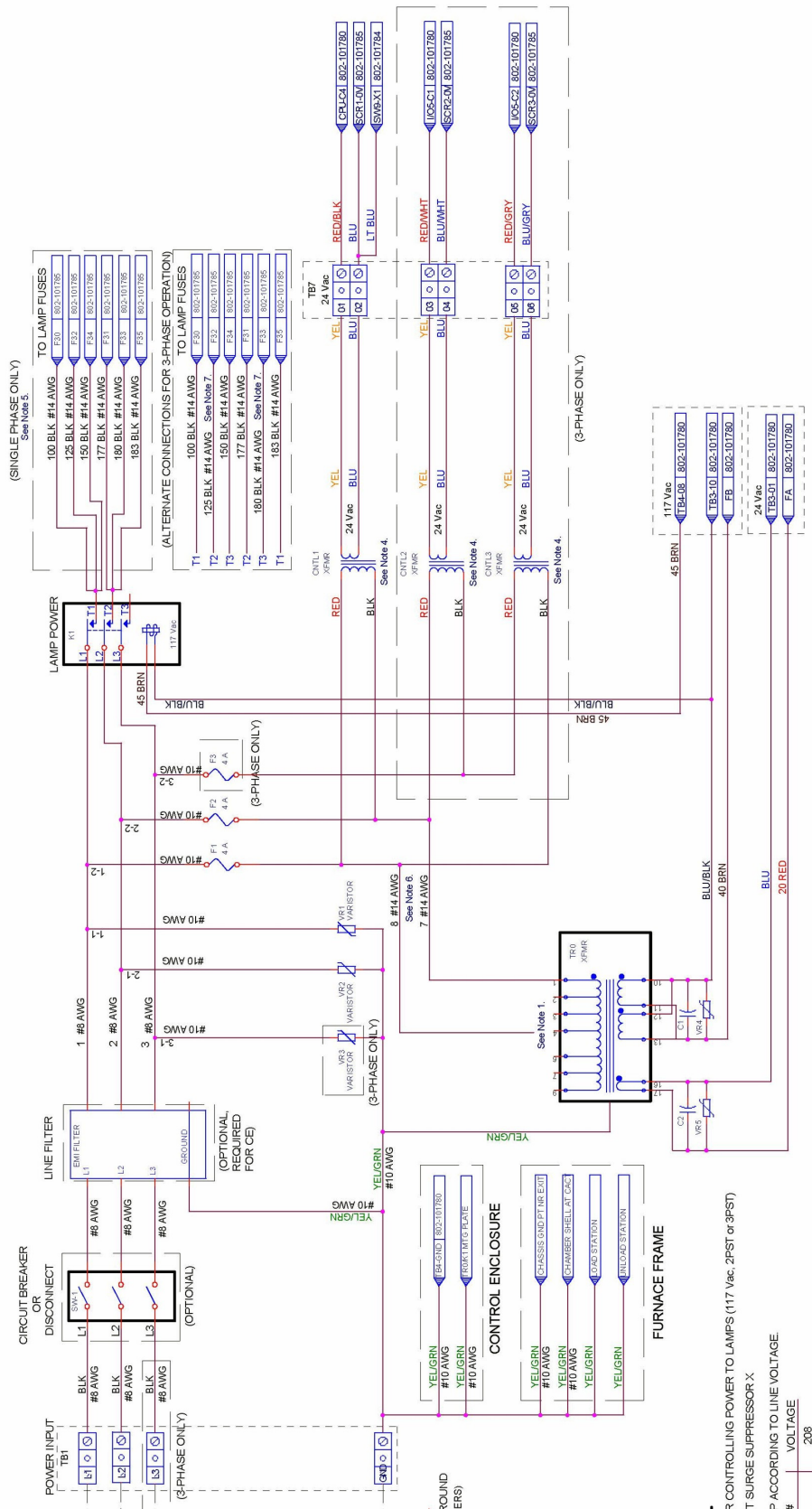

- NOTES**
- K1 - CONTACTOR CONTROLLING POWER TO LAMPS (117 Vac, 2PST or 3PST)
 VRX - TRANSIENT SURGE SUPPRESSOR X
 - CONNECT TAP ACCORDING TO LINE VOLTAGE
 - WIRE COLOR CODE:
 RED SOLID OR STRIPE - 24 Vac CONTROL
 BLUE SOLID OR BLUE WITH WHITE OR GRAY STRIPE - 24 Vac NEUTRAL (COMMON)
 BROWN SOLID - 117 Vac POWER
 BLUE WITH BLACK STRIPE - 117 Vac NEUTRAL (COMMON)
 BLACK SOLID - LINE TO LINE VOLTAGE (208-240 Vac)
 YELLOW WITH GREEN STRIPE - SAFETY (EARTH) GROUND
 - CONNECT LEAD ACCORDING TO LINE VOLTAGE (SINGLE PHASE) OR LINE-TO-LINE VOLTAGE (3-PHASE)
 - FOR 3-PHASE OPERATION USE ALTERNATE T1, T2, T3 CONNECTIONS
 - FOR 3-PHASE OPERATION CONNECT WIRE 8 FROM TR0 TAP TO F2 OUTPUT AND WIRE 7 FROM TR0-1 TO F3 OUTPUT
 - FOR HIGH-POWER CONFIGURATIONS, USE #10 AWG WIRE

LEAD	VOLTAGE
RED	208
RED	220
RED	230 or 240

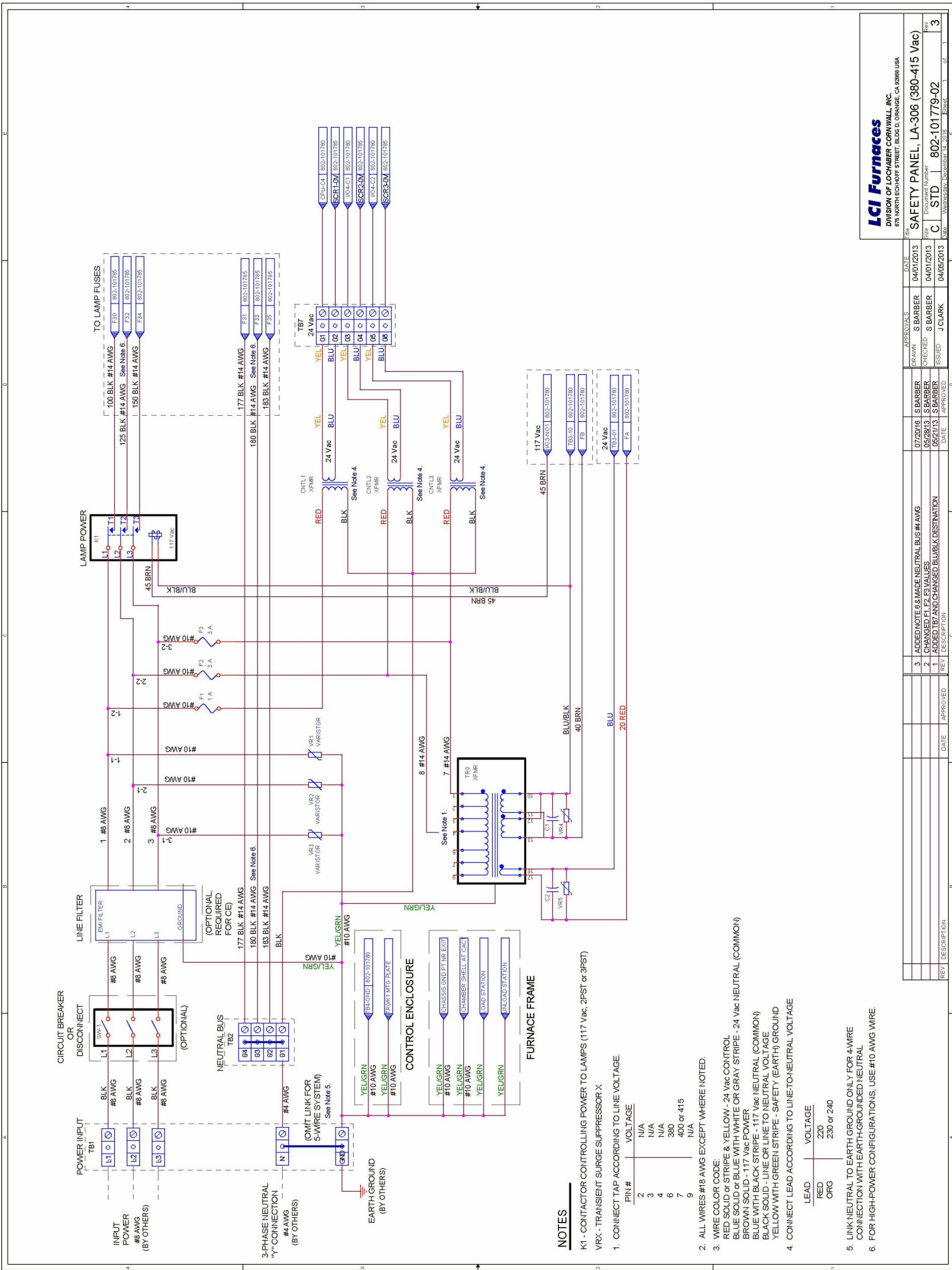

NOTES

- K1 - CONTACTOR CONTROLLING POWER TO LAMPS (117 Vac, 2PST or 3PST)
- VRX - TRANSIENT SURGE SUPPRESSOR X

1. CONNECT TAP ACCORDING TO LINE VOLTAGE.

PIN #	VOLTAGE
2	N/A
3	N/A
4	N/A
6	380
7	400 or 415
9	N/A

- 2. ALL WIRES #18 AWG EXCEPT WHERE NOTED.
- 3. WIRE COLOR CODE:
 RED SOLID or STRIPE & YELLOW - 24 Vac CONTROL
 BLUE SOLID or BLUE WITH WHITE OR GRAY STRIPE - 24 Vac NEUTRAL (COMMON)
 BROWN SOLID - 117 Vac POWER
 BLUE WITH BLACK STRIPE - 117 Vac NEUTRAL (COMMON)
 BLACK SOLID - LINE OR LINE TO NEUTRAL VOLTAGE
 YELLOW WITH GREEN STRIPE - SAFETY (EARTH) GROUND
- 4. CONNECT LEAD ACCORDING TO LINE-TO-NEUTRAL VOLTAGE

LEAD VOLTAGE

LEAD	VOLTAGE
RED	220
ORG	230 or 240

- 5. LINK NEUTRAL TO EARTH-GROUND ONLY FOR 4-WIRE CONNECTION WITH EARTH-GROUNDED NEUTRAL
- 6. FOR HIGH-POWER CONFIGURATIONS, USE #10 AWG WIRE

REV	DESCRIPTION	DATE	APPROVED	REV	DESCRIPTION	DATE	APPROVED
3	ADDED NOTE 6 & MADE NEUTRAL BUS #14 AWG	07/20/16	S BARBER	3	SAFETY PANEL, LA-306 (380-415 Vac)	04/01/2013	S BARBER
2	CHANGED F1, F2, F3 VALUES	06/28/13	S BARBER	2	SAFETY PANEL, LA-306 (380-415 Vac)	04/01/2013	S BARBER
1	ADDED TB1 AND CHANGED BLUBLK DESTINATION	06/27/13	S BARBER	1	SAFETY PANEL, LA-306 (380-415 Vac)	04/05/2013	J CLARK

LCI Furnaces
 DIVISION OF LOCHNER CORNWALL, INC.
 676 NORTH ECHOFF STREET, BLDG D, ORANGE, CA 92668 USA

**AUTO GAS SHUTOFF
802-101780-01 POWER CONTROL SCHEMATIC
NOTE 2**

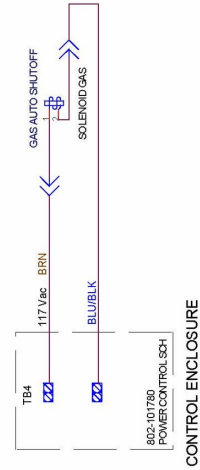

TO ADJUST GAS PRESSURE SWITCH SETPOINT:
 CW = RAISES SETPOINT (ALARMS AT HIGHER PRESSURE. REQUIRES MORE PRESSURE TO RELEASE ALARM)
 CCW = LOWERS SETPOINT (ALARMS AT LOWER PRESSURE. REQUIRES LOWER PRESSURE TO RELEASE ALARM)

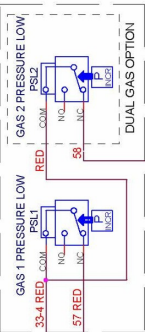

GAS MANIFOLDS

58 RED

CONTROL ENCLOSURE

CABINET EXHAUST FAN

CACT COOLING FANS (NOTE 1)

ON LA-306 MODEL ONLY

CONTROL ENCLOSURE

- 802-101780 TB4-03 33-4 RED 24 Vdc
- 802-101780 U5-3 57 RED
- 802-101784 U5-4 58 RED

MOTOR CONTROL PANEL

30 PPR x 1800 RPM

SL01 DIGITAL RATE METER (PANEL MOUNT)

10K 1/2 WATT

10K 1/2 WATT

10K 1/2 WATT

10K 1/2 WATT

10K 1/2 WATT

10K 1/2 WATT

10K 1/2 WATT

10K 1/2 WATT

10K 1/2 WATT

10K 1/2 WATT

10K 1/2 WATT

10K 1/2 WATT

10K 1/2 WATT

10K 1/2 WATT

10K 1/2 WATT

10K 1/2 WATT

10K 1/2 WATT

10K 1/2 WATT

10K 1/2 WATT

10K 1/2 WATT

10K 1/2 WATT

10K 1/2 WATT

10K 1/2 WATT

10K 1/2 WATT

10K 1/2 WATT

10K 1/2 WATT

10K 1/2 WATT

10K 1/2 WATT

10K 1/2 WATT

10K 1/2 WATT

10K 1/2 WATT

10K 1/2 WATT

10K 1/2 WATT

10K 1/2 WATT

10K 1/2 WATT

10K 1/2 WATT

10K 1/2 WATT

10K 1/2 WATT

10K 1/2 WATT

10K 1/2 WATT

- NOTES (cont.):
9. SET LA-306 MOTOR FOR 1/20 HP. LA-308P FOR 1/8 HP.
 10. SOURCE OF BLU/BLK WIRES:
 LA-306 -- 802-101780 / TB4-07
 LA-308P -- 802-101780 / K3-8
 11. A1 MOTOR CONNECTION COLOR VARIES BY MOTOR.

- NOTES:
1. NUMBER OF FANS MAY VARY.
 2. SUPPLIED WITH OPTIONAL EQUIPMENT.
 3. ALL WIRES 18 AWG UNLESS OTHERWISE NOTED.
 4. ALL MULTI-CONDUCTOR CABLE 22 AWG WIRES.
 5. WIRE R01 FOR CW INCREASE IN MOTOR SPEED.
 6. INSERT LAMPS IN CORRESPONDING HOLES ON PANEL.
 7. REVERSE +ARM AND -ARM FOR PROPER MOTOR ROTATION.
 8. SET BOARD JUMPER TO SIGNAL AS SHOWN.

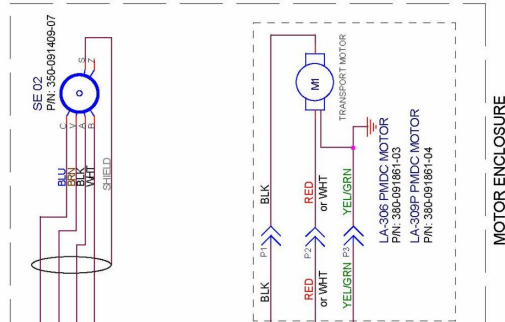

MOTOR ENCLOSURE

LCI Furnaces
 DIVISION OF LOCHMAYER CORNWALL INC.
 676 NORTH ECKHOFF STREET, BLOOMINGDALE, IL 61702

MODEL: LCI LA-306, -308P
 APPROVALS: DATE

DATE	REVISION	DESCRIPTION
03/19/2014	1	AT MOTOR CONNECTION NOTE 11 ADDED
03/19/2014	2	REVISION FOR RELEASE 02/18/14
03/19/2014	3	ISSUED
03/19/2014	4	APPROVED

DRAWN: S BARBER
 CHECKED: S BARBER
 ISSUED: J CLARK

DATE: 03/19/2014

DATE: 03/19/2014

DATE: 03/19/2014

DATE: 03/19/2014

DATE: 03/19/2014

DATE: 03/19/2014

DATE: 03/19/2014

DATE: 03/19/2014

DATE: 03/19/2014

DATE: 03/19/2014

DATE: 03/19/2014

DATE: 03/19/2014

DATE: 03/19/2014

DATE: 03/19/2014

DATE: 03/19/2014

DATE: 03/19/2014

DATE: 03/19/2014

DATE: 03/19/2014

DATE: 03/19/2014

DATE: 03/19/2014

DATE: 03/19/2014

DATE: 03/19/2014

DATE: 03/19/2014

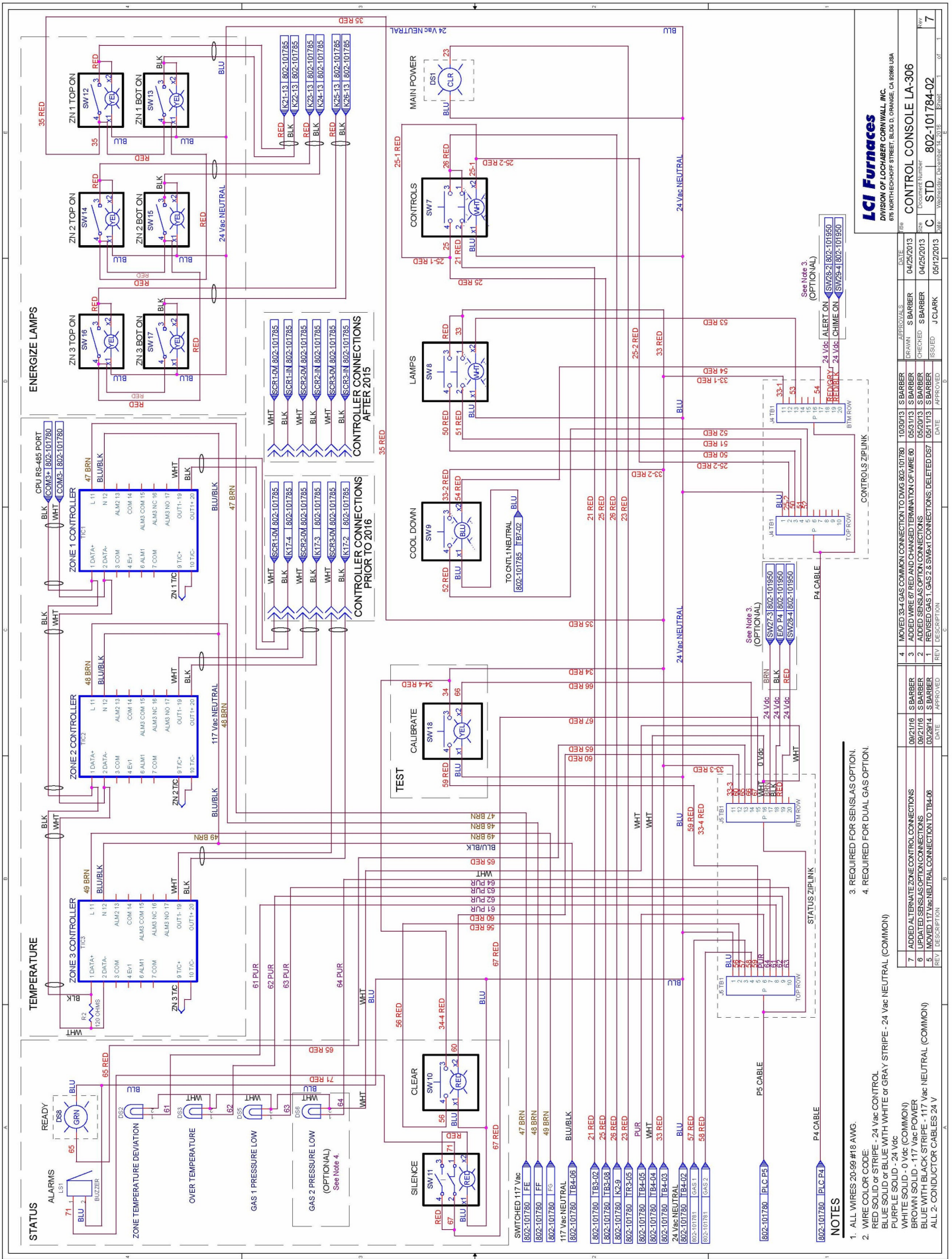

Lci Furnaces
 DIVISION OF LOCHABER CORNWALL INC.
 675 NORTH HEDDOFF STREET, BLDG D, ORANGE, CA 92668 USA

CONTROL CONSOLE LA-306

NO.	DATE	APPROVED	BY	DESCRIPTION
1	04/25/2013	S BARBER	J CLARK	REVISED
2	05/20/13	S BARBER	J CLARK	REVISED
3	05/20/13	S BARBER	J CLARK	REVISED
4	05/20/13	S BARBER	J CLARK	REVISED
5	05/20/13	S BARBER	J CLARK	REVISED
6	05/20/13	S BARBER	J CLARK	REVISED
7	05/20/13	S BARBER	J CLARK	REVISED
8	05/20/13	S BARBER	J CLARK	REVISED
9	05/20/13	S BARBER	J CLARK	REVISED
10	05/20/13	S BARBER	J CLARK	REVISED
11	05/20/13	S BARBER	J CLARK	REVISED
12	05/20/13	S BARBER	J CLARK	REVISED
13	05/20/13	S BARBER	J CLARK	REVISED
14	05/20/13	S BARBER	J CLARK	REVISED
15	05/20/13	S BARBER	J CLARK	REVISED
16	05/20/13	S BARBER	J CLARK	REVISED
17	05/20/13	S BARBER	J CLARK	REVISED
18	05/20/13	S BARBER	J CLARK	REVISED
19	05/20/13	S BARBER	J CLARK	REVISED
20	05/20/13	S BARBER	J CLARK	REVISED
21	05/20/13	S BARBER	J CLARK	REVISED
22	05/20/13	S BARBER	J CLARK	REVISED
23	05/20/13	S BARBER	J CLARK	REVISED
24	05/20/13	S BARBER	J CLARK	REVISED
25	05/20/13	S BARBER	J CLARK	REVISED
26	05/20/13	S BARBER	J CLARK	REVISED
27	05/20/13	S BARBER	J CLARK	REVISED
28	05/20/13	S BARBER	J CLARK	REVISED
29	05/20/13	S BARBER	J CLARK	REVISED
30	05/20/13	S BARBER	J CLARK	REVISED
31	05/20/13	S BARBER	J CLARK	REVISED
32	05/20/13	S BARBER	J CLARK	REVISED
33	05/20/13	S BARBER	J CLARK	REVISED
34	05/20/13	S BARBER	J CLARK	REVISED
35	05/20/13	S BARBER	J CLARK	REVISED
36	05/20/13	S BARBER	J CLARK	REVISED
37	05/20/13	S BARBER	J CLARK	REVISED
38	05/20/13	S BARBER	J CLARK	REVISED
39	05/20/13	S BARBER	J CLARK	REVISED
40	05/20/13	S BARBER	J CLARK	REVISED
41	05/20/13	S BARBER	J CLARK	REVISED
42	05/20/13	S BARBER	J CLARK	REVISED
43	05/20/13	S BARBER	J CLARK	REVISED
44	05/20/13	S BARBER	J CLARK	REVISED
45	05/20/13	S BARBER	J CLARK	REVISED
46	05/20/13	S BARBER	J CLARK	REVISED
47	05/20/13	S BARBER	J CLARK	REVISED
48	05/20/13	S BARBER	J CLARK	REVISED
49	05/20/13	S BARBER	J CLARK	REVISED
50	05/20/13	S BARBER	J CLARK	REVISED
51	05/20/13	S BARBER	J CLARK	REVISED
52	05/20/13	S BARBER	J CLARK	REVISED
53	05/20/13	S BARBER	J CLARK	REVISED
54	05/20/13	S BARBER	J CLARK	REVISED
55	05/20/13	S BARBER	J CLARK	REVISED
56	05/20/13	S BARBER	J CLARK	REVISED
57	05/20/13	S BARBER	J CLARK	REVISED
58	05/20/13	S BARBER	J CLARK	REVISED
59	05/20/13	S BARBER	J CLARK	REVISED
60	05/20/13	S BARBER	J CLARK	REVISED
61	05/20/13	S BARBER	J CLARK	REVISED
62	05/20/13	S BARBER	J CLARK	REVISED
63	05/20/13	S BARBER	J CLARK	REVISED
64	05/20/13	S BARBER	J CLARK	REVISED
65	05/20/13	S BARBER	J CLARK	REVISED
66	05/20/13	S BARBER	J CLARK	REVISED
67	05/20/13	S BARBER	J CLARK	REVISED
68	05/20/13	S BARBER	J CLARK	REVISED
69	05/20/13	S BARBER	J CLARK	REVISED
70	05/20/13	S BARBER	J CLARK	REVISED
71	05/20/13	S BARBER	J CLARK	REVISED
72	05/20/13	S BARBER	J CLARK	REVISED
73	05/20/13	S BARBER	J CLARK	REVISED
74	05/20/13	S BARBER	J CLARK	REVISED
75	05/20/13	S BARBER	J CLARK	REVISED
76	05/20/13	S BARBER	J CLARK	REVISED
77	05/20/13	S BARBER	J CLARK	REVISED
78	05/20/13	S BARBER	J CLARK	REVISED
79	05/20/13	S BARBER	J CLARK	REVISED
80	05/20/13	S BARBER	J CLARK	REVISED
81	05/20/13	S BARBER	J CLARK	REVISED
82	05/20/13	S BARBER	J CLARK	REVISED
83	05/20/13	S BARBER	J CLARK	REVISED
84	05/20/13	S BARBER	J CLARK	REVISED
85	05/20/13	S BARBER	J CLARK	REVISED
86	05/20/13	S BARBER	J CLARK	REVISED
87	05/20/13	S BARBER	J CLARK	REVISED
88	05/20/13	S BARBER	J CLARK	REVISED
89	05/20/13	S BARBER	J CLARK	REVISED
90	05/20/13	S BARBER	J CLARK	REVISED
91	05/20/13	S BARBER	J CLARK	REVISED
92	05/20/13	S BARBER	J CLARK	REVISED
93	05/20/13	S BARBER	J CLARK	REVISED
94	05/20/13	S BARBER	J CLARK	REVISED
95	05/20/13	S BARBER	J CLARK	REVISED
96	05/20/13	S BARBER	J CLARK	REVISED
97	05/20/13	S BARBER	J CLARK	REVISED
98	05/20/13	S BARBER	J CLARK	REVISED
99	05/20/13	S BARBER	J CLARK	REVISED
100	05/20/13	S BARBER	J CLARK	REVISED

- NOTES**
- ALL WIRES 20-56 #18 AWG.
 - WIRE COLOR CODES: 24 VAC CONTROL: RED, SOLID OR BLUE WITH WHITE OR GRAY STRIPE; 24 VAC NEUTRAL (COMMON): PURPLE SOLID - 24 VAC; WHITE SOLID - 0 VDC (COMMON); BROWN SOLID - 117 VAC POWER; BLUE WITH BLACK STRIPE - 117 VAC NEUTRAL (COMMON); ALL 2- CONDUCTOR CABLES 24 V
 - REQUIRED FOR SENSAS OPTION.
 - REQUIRED FOR DUAL GAS OPTION.

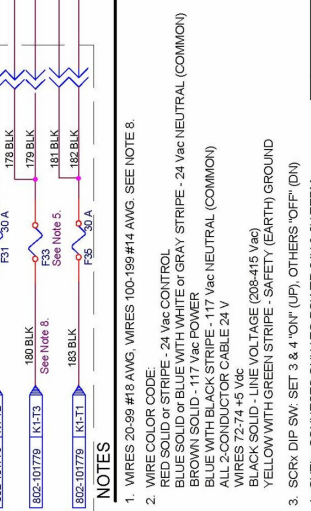
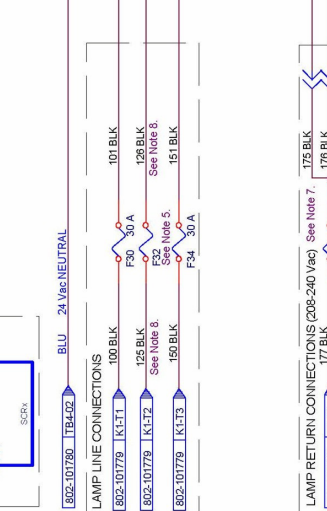
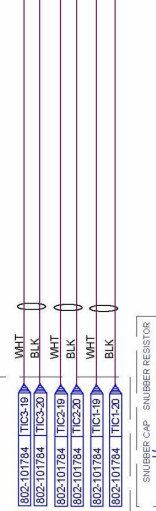
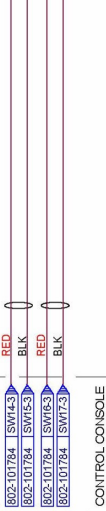
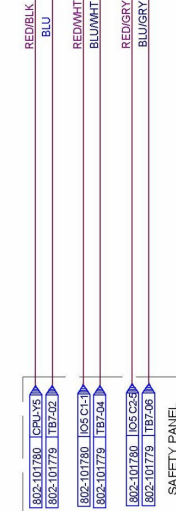

- NOTES**
1. WIRES 20-99 #18 AWG, WIRES 100-169 #14 AWG. SEE NOTE 8.
 2. WIRE COLOR CODE:
RED SOLID OR STRIPE - 24 Vac CONTROL
BLUE SOLID OR STRIPE WITH WHITE OR GRAY STRIPE - 24 Vac NEUTRAL (COMMON)
BLACK SOLID OR STRIPE WITH GRAY STRIPE - 120/240 Vac NEUTRAL (COMMON)
ALL 2-CONDUCTOR CABLE 24 V
WIRES 72-74 +5 Vdc
BLACK SOLID - LINE VOLTAGE (208-415 Vdc)
YELLOW WITH GREEN STRIPE - SAFETY (EARTH) GROUND
 3. SCR: DIP SW- SET 3 & 4 "ON" (UP), OTHERS "OFF" (DN)
 4. CNTX CONNECTS ONLY TO POWER 24V & 0V TERM.
 5. F32 & F33 30A STANDARD, 40A HIGH POWER MODELS

- ALTERNATE LAMP RETURN CONNECTIONS (208-415 Vdc) See Note 7.**
- 182 BLK F31 30 A See Note 5.
 - 178 BLK F32 30 A See Note 8.
 - 183 BLK F35 30 A See Note 5.

- USE INSET FOR OPTIONAL ZONE 2 HIGH POWER RELAY WIRING.**
7. USE APPROPRIATE LAMP RETURN CONNECTIONS BASED ON FURNACE LINE VOLTAGE.
 8. FOR HIGH POWER MODELS, WIRES 126, 126 & 180 ARE #10 AWG.

REV	DATE	APPROVALS	DATE
1	09/20/2016	S BARBER	09/20/2016
0	09/20/2016	S BARBER	09/20/2016
0		S BARBER	
		J CLARK	

ZONE CONTROL LA-306 AFTER 2015

802-101785-07

802-101785-07

802-101785-07

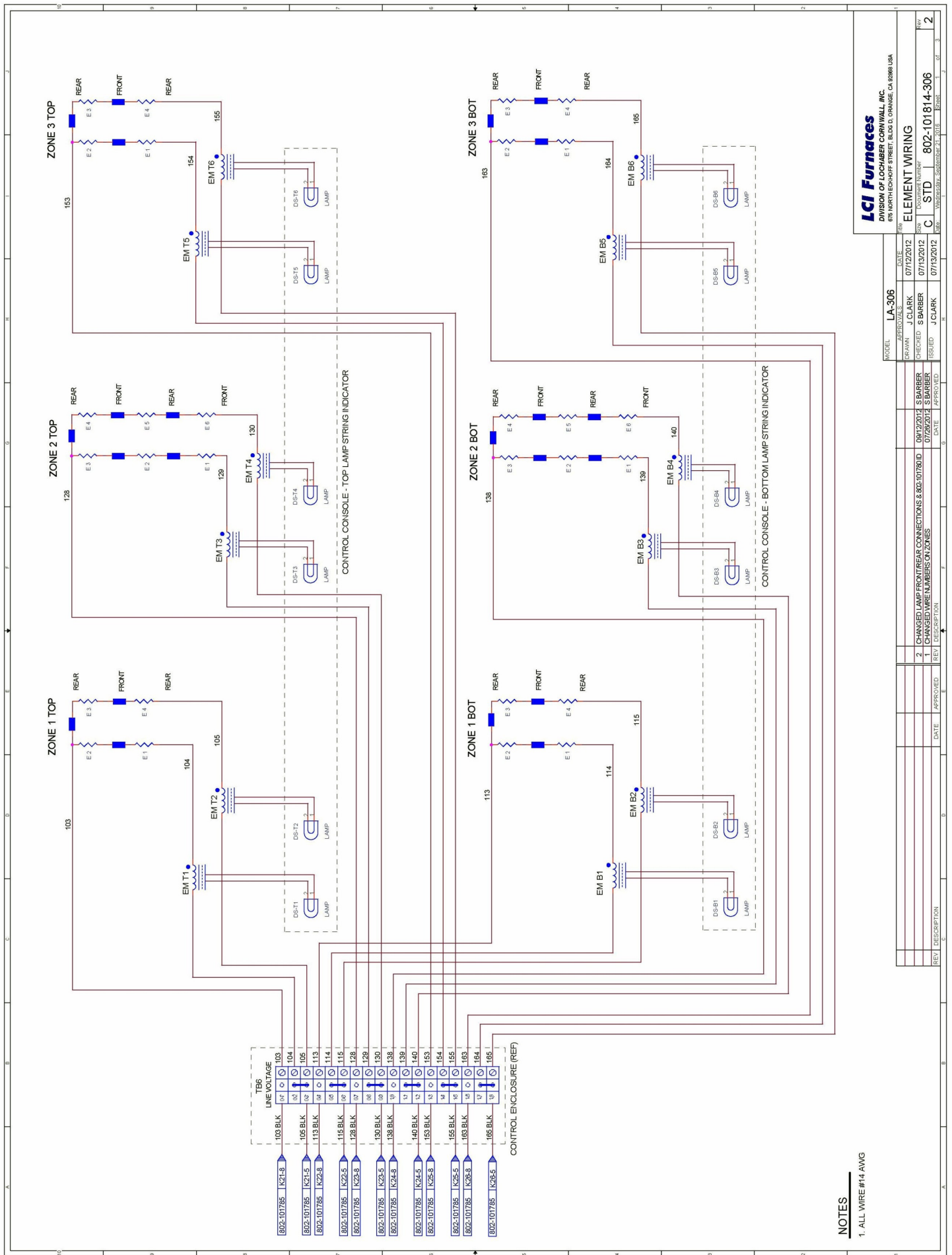

LCI Furnaces
 DIVISION OF LOCHABER CORNWALL, INC.
 675 NORTH HOFF STREET, BLDG D, ORANGE, CA 92668 USA

REV	DESCRIPTION	DATE	APPROVED	BY	DATE	APPROVED	BY
2	CHANGED LAMP FRONT/REAR CONNECTIONS & 802-101780 ID	09/12/2012	S BARBER				
1	ADDED WIRE NUMBERS ON ZONES	07/13/2012	J CLARK				

MODEL	LA-306	DATE	07/12/2012
DRAWN	J CLARK	CHECKED	S BARBER
ISSUED	J CLARK	APPROVED	J CLARK

REV	DESCRIPTION	DATE	APPROVED	BY
2	ELEMENT WIRING	07/13/2012	J CLARK	
1	ISSUED	07/13/2012	J CLARK	

NOTES
 1. ALL WIRE #14 AWG

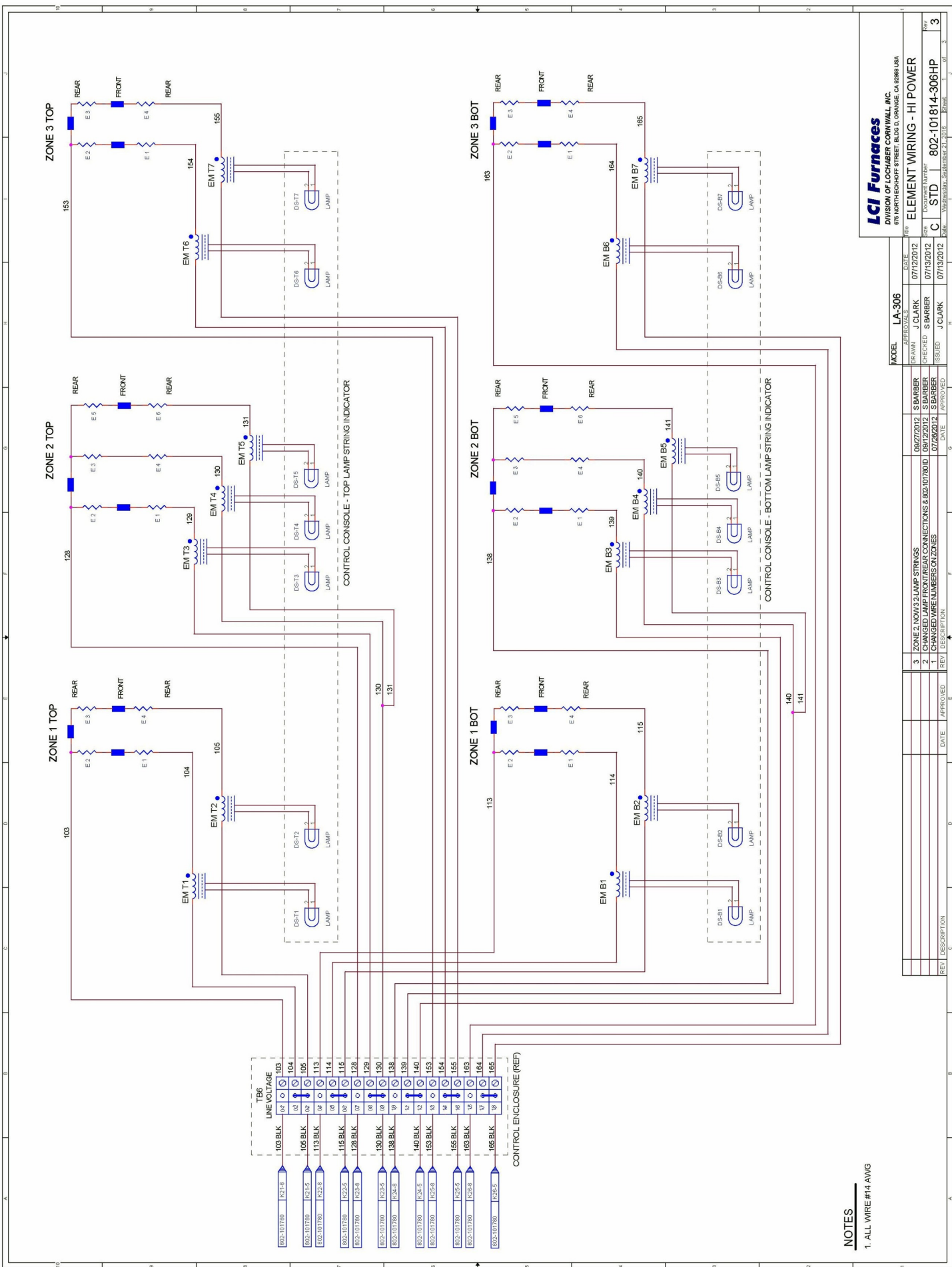

NOTES

- 1. ALL WIRE #14 AWG

LCI Furnaces
 DIVISION OF LOCHABER CORNWALL INC
 674 NORTH HEDDHOFF STREET, BLDG D, ORANGE, CA 92668 USA

MODEL	LA-306	DATE	07/12/2012
APPROVALS	J. CLARK	CHECKED	S. BARBER
DRAWN	S. BARBER	ISSUED	J. CLARK
REV	DESCRIPTION	DATE	APPROVED
3	ZONE 2, NOW 3 LAMP STRINGS	06/27/2012	S. BARBER
2	CHANGED LAMP FRONT/REAR CONNECTIONS & 802-101780 ID	06/17/2012	S. BARBER
1	CHANGED WIRE NUMBERS ON ZONES	07/26/2012	S. BARBER
C	STD	07/13/2012	J. CLARK

REV	DESCRIPTION	DATE	APPROVED
3	ZONE 2, NOW 3 LAMP STRINGS	06/27/2012	S. BARBER
2	CHANGED LAMP FRONT/REAR CONNECTIONS & 802-101780 ID	06/17/2012	S. BARBER
1	CHANGED WIRE NUMBERS ON ZONES	07/26/2012	S. BARBER

REV	DESCRIPTION	DATE	APPROVED
3	ZONE 2, NOW 3 LAMP STRINGS	06/27/2012	S. BARBER
2	CHANGED LAMP FRONT/REAR CONNECTIONS & 802-101780 ID	06/17/2012	S. BARBER
1	CHANGED WIRE NUMBERS ON ZONES	07/26/2012	S. BARBER

REV	DESCRIPTION	DATE	APPROVED
3	ZONE 2, NOW 3 LAMP STRINGS	06/27/2012	S. BARBER
2	CHANGED LAMP FRONT/REAR CONNECTIONS & 802-101780 ID	06/17/2012	S. BARBER
1	CHANGED WIRE NUMBERS ON ZONES	07/26/2012	S. BARBER

REV	DESCRIPTION	DATE	APPROVED
3	ZONE 2, NOW 3 LAMP STRINGS	06/27/2012	S. BARBER
2	CHANGED LAMP FRONT/REAR CONNECTIONS & 802-101780 ID	06/17/2012	S. BARBER
1	CHANGED WIRE NUMBERS ON ZONES	07/26/2012	S. BARBER

REV	DESCRIPTION	DATE	APPROVED
3	ZONE 2, NOW 3 LAMP STRINGS	06/27/2012	S. BARBER
2	CHANGED LAMP FRONT/REAR CONNECTIONS & 802-101780 ID	06/17/2012	S. BARBER
1	CHANGED WIRE NUMBERS ON ZONES	07/26/2012	S. BARBER

REV	DESCRIPTION	DATE	APPROVED
3	ZONE 2, NOW 3 LAMP STRINGS	06/27/2012	S. BARBER
2	CHANGED LAMP FRONT/REAR CONNECTIONS & 802-101780 ID	06/17/2012	S. BARBER
1	CHANGED WIRE NUMBERS ON ZONES	07/26/2012	S. BARBER

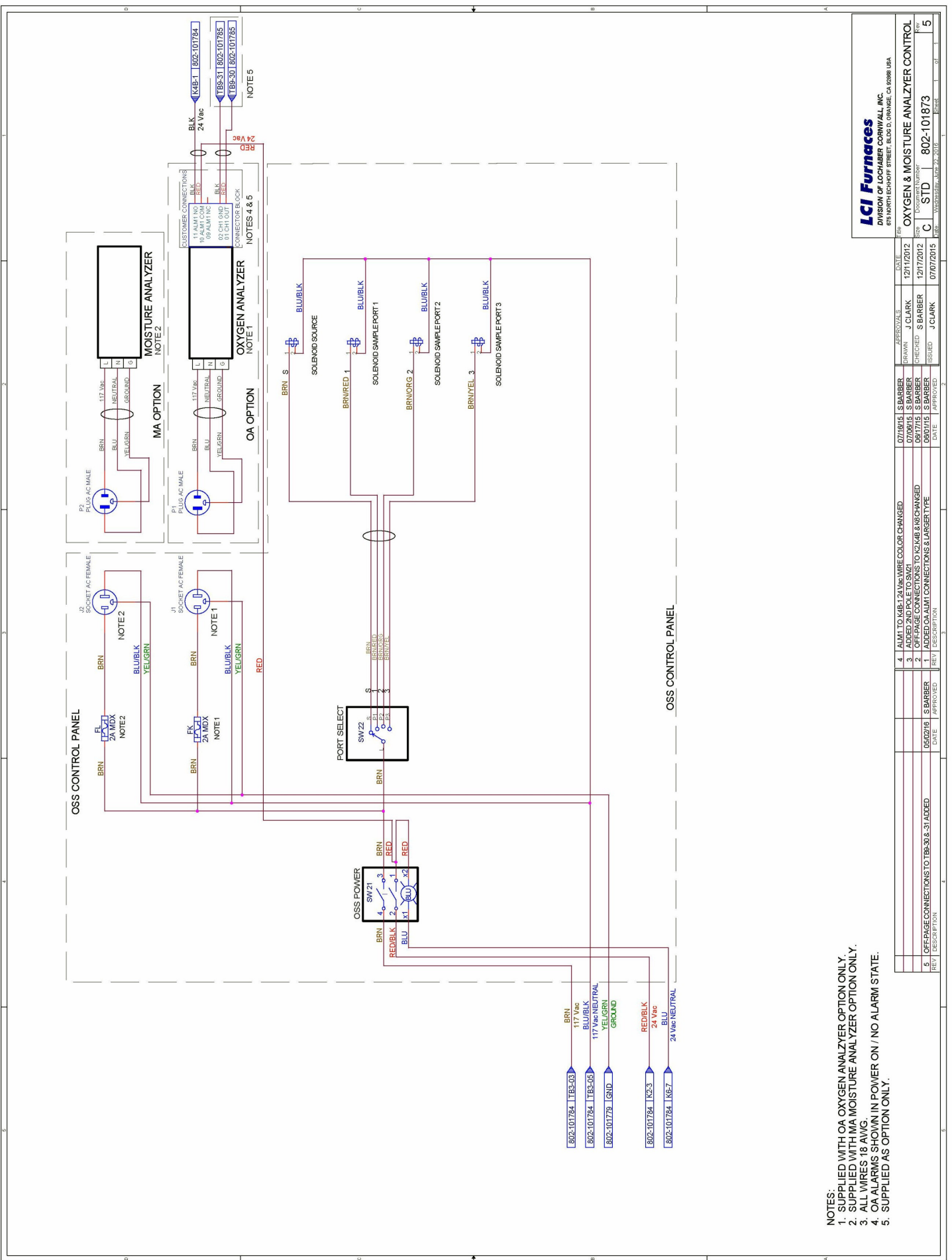

- NOTES:**
- SUPPLIED WITH OA OXYGEN ANALYZER OPTION ONLY.
 - SUPPLIED WITH MA MOISTURE ANALYZER OPTION ONLY.
 - ALL WIRES 18 AWG
 - OA ALARMS SHOWN IN POWER ON / NO ALARM STATE.
 - SUPPLIED AS OPTION ONLY.

LCI Furnaces
 DIVISION OF LOCHABER CORNWALL INC.
 678 NORTH ECHOFF STREET, BLDG D, ORANJE, CA 92686 USA

DATE: 07/07/2015
 DRAWN: J CLARK
 CHECKED: S BARBER
 ISSUED: J CLARK

REV: 5
 TITLE: OXYGEN & MOISTURE ANALYZER CONTROL

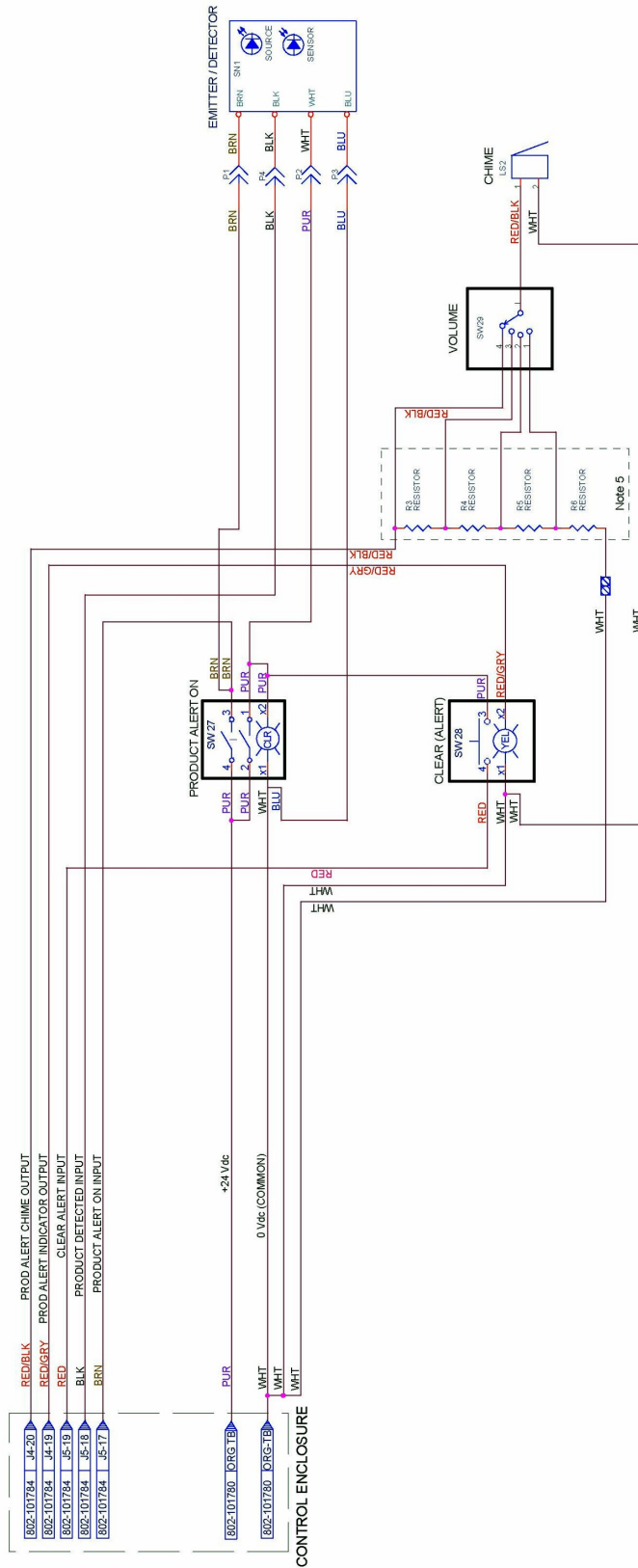

NOTES

1. SUPPLIED WITH PRODUCT ALERT OPTION ONLY.
2. NOT SUPPLIED ON ALL SYSTEMS
3. ALL WIRES 18 AWG, UNLESS NOTED.
4. WIRE COLOR CODE
 PURPLE - 24 Vdc
 BLACK - 24 Vdc
 WHITE - 0 Vdc (COMMON)
 SN1 EMITTER/DETECTOR CONNECTIONS ONLY:
 BROWN - WHITE + 24 Vdc
 BLACK - 24 Vdc
 BLUE - 0 Vdc (COMMON)
5. R3, R4, R5, R6 VALUES:
 R3 - 470 OHM, 1 WATT
 R4 - 750 OHM, 1/2 WATT
 R5 - 1600 OHM, 1/4 WATT
 R6 - 6200 OHM, 1/4 WATT

LCI Furnaces
 DIVISION OF LOCHABER CORNWALL, INC.
 676 NORTH ECKHOFF STREET, BLDG D, ORANGE, CA 92668 USA

DATE	06/13/2016
ISSUED	J CLARK
APPROVED	J CLARK
REV	0
DESCRIPTION	802-101950-03

SPECIFICATIONS

11.1 Furnace Specifications	11-2
11.2 Fuse List	11-3
11.3 Average 3-ph Current at Temperature	11-4
11.4 Average 1-ph Current at Temperature	11-5

11.1 Furnace Specifications

LCI Furnaces <small>DIVISION OF LOCHABER CORNWALL INC</small>	DATA SHEET	DOC NBR: STD 802-101529 R1		
	IR FURNACE SYSTEM BASE FUSE LIST	MODEL: LA-306	APVL: SLB	5/8/13
SPECIFICATIONS		SERIAL NBR: ALL	PRNT: 19Jun13	
		DATE: 05/08/13	SHT 1	of 1

STANDARD LA-306

Safety Enclosure (TR0, basic control)		
Fuse Label	Size (A)	Comments
FA	5	24 Vac control, AGC
FB	4	117 Vac power, AGC
1 Phase or 3 Phase, 208-240 Vac Operation (* for 3 Phase only)		
F1	4	To TR0 & CNTL1, L1 leg, KTK
F2	4	To TR0 & CNTL2*, L2 leg, KTK
F3*	4	To CNTL3*, L3 leg, KTK
3 Phase, 380-415 Vac Operation		
F1	1	To CNTL1, L1 leg, KTK
F2	3	To TR0 & CNTL2, L2 leg, KTK
F3	3	To TR0 & CNTL3, L3 leg, KTK

Power Distribution Panel		
Fuse Label	Size (A)	Comments
FE	1	Zone Controller 1, 117 Vac, AGC
EF	1	Zone Controller 2, 117 Vac, AGC
FG	1	Zone Controller 3, 117 Vac, AGC
FH	1	Belt Speed Readout, 117 Vac, AGC
FJ	2	PLC Power Supply, 117 Vac, AGC

Belt Motor Controller		
Fuse Label	Size (A)	Comments
Line Fuse	15	On control board, ABC (ceramic)
Motor Fuse	1.5 or 2	On control board, varies w/ motor, ABC

Heating Lamp/Edge Heat SCR Fuses (all KTK)		
Fuse Label	Size (A)	Comments
F30	20.0	Zone 1 Top, 208-240 Vac, KTK
F31	20.0	Zone 1 Bottom, 208-240 Vac, KTK
F32	20.0	Zone 2 Top, 208-240 Vac, KTK
F33	20.0	Zone 2 Bottom, 208-240 Vac, KTK
F34	20.0	Zone 3 Top, 208-240 Vac, KTK
F35	20.0	Zone 3 Bottom Top, 208-240 Vac, KTK

HIGH POWER LA-306

Safety Enclosure (TR0, basic control)		
Fuse Label	Size (A)	Comments
FA	5	24 Vac control, AGC
FB	4	117 Vac power, AGC
1 Phase or 3 Phase, 208-240 Vac Operation (* for 3 Phase only)		
F1	4	To TR0 & CNTL1, L1 leg, KTK
F2	4	To TR0 & CNTL2*, L2 leg, KTK
F3*	4	To CNTL3*, L3 leg, KTK
3 Phase, 380-415 Vac Operation		
F1	1	To CNTL1, L1 leg, KTK
F2	3	To TR0 & CNTL2, L2 leg, KTK
F3	3	To TR0 & CNTL3, L3 leg, KTK

Power Distribution Panel		
Fuse Label	Size (A)	Comments
FE	1	Zone Controller 1, 117 Vac, AGC
EF	1	Zone Controller 2, 117 Vac, AGC
FG	1	Zone Controller 3, 117 Vac, AGC
FH	1	Belt Speed Readout, 117 Vac, AGC
FJ	2	PLC Power Supply, 117 Vac, AGC

Belt Motor Controller		
Fuse Label	Size (A)	Comments
Line Fuse	15	On control board, ABC (ceramic)
Motor Fuse	1.5 or 2	On control board, varies w/ motor, ABC

Heating Lamp/Edge Heat SCR Fuses (all KTK)		
Fuse Label	Size (A)	Comments
F30	20.0	Zone 1 Top, 208-240 Vac, KTK
F31	20.0	Zone 1 Bottom, 208-240 Vac, KTK
F32	25.0	Zone 2 Top, 208-240 Vac, KTK
F33	25.0	Zone 2 Bottom, 208-240 Vac, KTK
F34	20.0	Zone 3 Top, 208-240 Vac, KTK
F35	20.0	Zone 3 Bottom Top, 208-240 Vac, KTK

11.3 Average 3-ph Current at Temperature

Expected three phase current draw when stabilized at various temperatures.

11.4 Average 1-ph Current at Temperature

Expected single phase current draw when stabilized at various temperatures.

12.1 MSDS M0090 Fiberfrax® QF Cements.....	12-2
12.2 MSDS M0042 Fiberfrax® Duraboard®	12-8
12.3 Fiberfrax® Refractory Ceramic Fiber MSDS 0001.....	12-14
12.4 MSDS M0055 Fiberfrax® High Purity Papers.....	12-20
12.5 Kaowool® Insulation MSDS 203	12-26
12.6 MSDS 0732 RTV Silicone 732	12-31
12.7 MSDS MagnaForm Boards	12-32

12.1 MSDS M0090 Fiberfrax® QF Cements

maximize rodent respirability.

OTHER POTENTIAL EFFECTS	
TARGET ORGANS: Respiratory Tract (nose & throat), Eyes, Skin	
RESPIRATORY TRACT (nose & throat) IRRITATION: If dried, airborne product is inhaled in sufficient quantity, may cause temporary, mild mechanical irritation to respiratory tract. Symptoms may include scratchiness of the nose or throat, cough or chest discomfort.	
EYE IRRITATION: May cause temporary, mild mechanical irritation. Fibers may be abrasive; prolonged contact may cause damage to the outer surface of the eye.	
SKIN IRRITATION: Exposure to dried product may cause temporary, mild mechanical irritation. Exposure may also result in inflammation, rash or itching.	
GASTROINTESTINAL IRRITATION: Unlikely route of exposure. Small amounts swallowed incidental to normal handling operations are not likely to cause injury.	
MEDICAL CONDITIONS AGGRAVATED BY EXPOSURE: Pre-existing medical conditions, including dermatitis, asthma or chronic lung disease may be aggravated by exposure; individuals who have a history of allergies may experience greater amounts of skin and respiratory irritation.	

HAZARD CLASSIFICATION

Although studies, involving occupationally exposed workers, have not identified any increased incidence of respiratory disease, results from animal testing have been used as the basis for hazard classification. In each of the following cases, the conclusions are qualitative only and do not rest upon any quantitative analysis suggesting that the hazard actually may occur at current occupational exposure levels.

In October 2001, the **International Agency for Research on Cancer (IARC)** confirmed that Group 2b (possible human carcinogen) remains the appropriate IARC classification for RCF.

The Seventh Annual Report on Carcinogens (1994), prepared by the **National Toxicology Program (NTP)**, classified respirable RCF and glasswool as substances reasonably anticipated to be carcinogens.

The **American Conference of Governmental Industrial Hygienists (ACGIH)** has classified RCF as "A2-Suspected Human Carcinogen."

The **Commission of The European Communities (DG XI)** has classified RCF as a substance that should be regarded as if it is carcinogenic to man.

The **State of California**, pursuant to Proposition 65, The Safe Drinking Water and Toxic Enforcement Act of 1986, has listed "ceramic fibers (airborne fibers of respirable size)" as a

**MATERIAL SAFETY DATA SHEET**

MSDS No. M0090 Effective Date: 03/09/2004

1. CHEMICAL PRODUCT AND COMPANY IDENTIFICATION

Product Group: REFRACTORY CERAMIC FIBER PRODUCT
Chemical Name: VITREOUS ALUMINOSILICATE FIBER
Synonym(s): RCF, ceramic fiber, synthetic vitreous fiber (SVF), man-made vitreous fiber (MMVF), man-made mineral fiber (MMMF)
Trade Names: QF-150 Cement, QF-180 Cement, QF-180-AB Cement, QF-180 Blue Cement

Manufacturer/Supplier: Unifrax Corporation
 2351 Whirlpool St.
 Niagara Falls, NY 14305-2413

Product Stewardship Information Hotline
 1-800-322-2293 (Monday - Friday 8:00 a.m. - 4:30 p.m. EST)

For additional MSDSs, visit our web page, <http://www.unifrax.com>, or call Unifrax Customer Service at (716) 278-3872

CHEMTREC Assist: CHEMTREC will provide assistance for chemical emergencies. Call 1-800-424-9300

2. COMPOSITION / INFORMATION ON INGREDIENTS

COMPONENTS	CAS NUMBER	% BY WEIGHT
Refractories, Fibers, Aluminosilicate	142844-00-6	40-60
Water	7732-18-5	20-50
Silica (amorphous)	7631-86-9	10-15
Hydrated magnesium aluminum silicate mineral	12199-37-0	1-3

(See Section 8 "Exposure Controls / Personal Protection" for exposure guidelines)

3. HAZARDS IDENTIFICATION**EMERGENCY OVERVIEW**

CAUTION! MAY BE HARMFUL IF SWALLOWED.
 MAY CAUSE SKIN AND EYE IRRITATION.
 DRIED, ABRADED PRODUCT MAY CAUSE RESPIRATORY TRACT IRRITATION AND POSSIBLE CANCER HAZARD BY INHALATION.
 (See Section 11 for more information)

CHRONIC EFFECT

There has been no increased incidence of respiratory disease in studies examining occupationally exposed workers. In animal studies, long-term laboratory exposure to doses hundreds of times higher than normal occupational exposures has produced fibrosis, lung cancer, and mesothelioma in rats or hamsters. The fibers used in those studies were specially sized to

12.2 MSDS M0042 Fiberfrax® Duraboard®

If soiled work clothing must be taken home, employers should ensure employees are thoroughly trained on the best practices to minimize or avoid non-work dust exposure (e.g., vacuum clothes before leaving the work area, wash work clothing separately, rinse washer before washing other household clothes, etc.).

Eye Protection:

Wear safety glasses with side shields or other forms of eye protection in compliance with appropriate OSHA standards to prevent eye irritation. The use of contact lenses is not recommended, unless used in conjunction with appropriate eye protection. Do not touch eyes with soiled body parts or materials. If possible, have eye-washing facilities readily available where eye irritation can occur.

9. PHYSICAL AND CHEMICAL PROPERTIES

ODOR AND APPEARANCE: White, odorless, fibrous material
CHEMICAL FAMILY: Vitreous Aluminosilicate Fibers
BOILING POINT: Not Applicable
WATER SOLUBILITY (%): Not Soluble in Water
MELTING POINT: 1760° C (3200° F)
SPECIFIC GRAVITY: 2.50 – 2.75
VAPOR PRESSURE: Not Applicable
pH: Not Applicable
VAPOR DENSITY (Air = 1): Not Applicable
% VOLATILE MOLECULAR FORMULA: Not Applicable

10. STABILITY AND REACTIVITY

CHEMICAL STABILITY: Stable under conditions of normal use.
INCOMPATIBILITY: Soluble in hydrofluoric acid, phosphoric acid, and concentrated alkali.
CONDITIONS TO AVOID: None.
HAZARDOUS DECOMPOSITION PRODUCTS: Thermal decomposition of binder from fires or from first heat of product may release smoke, carbon monoxide, and carbon dioxide. Use adequate ventilation or other precautions to eliminate exposure to vapors resulting from thermal decomposition of binder. Exposure to thermal decomposition fumes may cause respiratory tract irritation, bronchial hyper-reactivity or an asthmatic-type response.
HAZARDOUS POLYMERIZATION: Not Applicable.

11. TOXICOLOGICAL INFORMATION

HEALTH DATA SUMMARY

Epidemiological studies of RCF production workers have indicated no increased incidence of respiratory disease nor other significant health effects. In animal studies, long-term, high-dose inhalation exposure resulted in the development of respiratory disease in rats and hamsters.

EPIDEMIOLOGY

The University of Cincinnati is conducting an ongoing epidemiologic investigation. The evidence obtained from employees in U. S. RCF manufacturing facilities is as follows:

- 1) There is no evidence of any fibrotic lung disease (interstitial fibrosis) from evaluations of chest X-rays.
- 2) There is no evidence of an elevated incidence of lung disease among RCF manufacturing employees.
- 3) In early studies, an apparent statistical "trend" was observed, in the exposed population, between RCF exposure duration and some measures of lung function. The observations were clinically insignificant. If these observations were made on an individual employee, the results would be interpreted as being within the normal (predicted) respiratory range. A more recent longitudinal study of employees with 5 or more pulmonary function tests found that there was no effect on lung function associated with RCF production experience. Initial data (circa 1987) seemed to indicate an interactive effect between smoking and RCF exposure; more recent data, however, found no interactive effect. Nevertheless, to promote good health, RCF employees are still actively encouraged not to smoke.
- 4) Pleural plaques (thickening along the chest wall) have been observed in a small number of RCF employees. Some studies appear to show a relationship between the occurrence of pleural plaques on chest radiographs and the following variables: (a) years since RCF production hire date; (b) duration of RCF production employment; and (c) cumulative RCF exposure. The best evidence to date indicates that pleural plaques are a marker of exposure only. Pleural plaques are not associated with pulmonary impairment. The pathogenesis of pleural plaques remains incompletely understood; however, the mechanism appears to be an inflammatory response caused by inhaled fibers.

TOXICOLOGY

A number of toxicological studies designed to identify any potential health effects from RCF exposure have been completed. In one study, conducted by the Research and Consulting Company, (Geneva, Switzerland), rats and hamsters were exposed to 30 mg/m³ (about 200 fibers/cc) of specially-prepared RCF for 6 hours/day, 5 days/week, for up to 24 months. In rats, a statistically significant increase in lung tumors was observed; two mesotheliomas (cancer of the pleural lining between the chest wall and lung) were also identified. Hamsters did not develop lung tumors; however, interstitial fibrosis and mesothelioma was found. Some, in the scientific community, have concluded that the "maximum tolerated dose" was exceeded and that significant particle contamination was a confounding issue; therefore, these study findings may not represent an accurate assessment of the potential for RCF to produce adverse health effects.

In a related multi-dose study with a similar protocol, other rats were exposed to doses of 16 mg/m³, 9 mg/m³, 3 mg/m³ which corresponds to about 115, 75, and 25 fibers per cubic centimeter respectively. This study found no statistically significant increase in lung cancer. Some cases of pleural and parenchymal fibrosis were seen in the 16 mg/m³ dose group. Some cases of mild fibrosis and one mesothelioma were observed in the 9 mg/m³ group. No acute respiratory effects were seen in the rats in the 3 mg/m³ exposure group, which suggests that there may be a dose/response threshold, below which irreversible respiratory impacts do not occur.

Other toxicological studies have been conducted which utilized non-physiological exposure methods such as intrapleural, intraperitoneal and intratracheal implantation or injection. Some of these studies have found that RCF is a potential carcinogen. Some experts, however, suggest

12.3 Fiberfrax® Refractory Ceramic Fiber MSDS 0001



12.4 MSDS M0055 Fiberfrax® High Purity Papers

12.5 Kaowool® Insulation MSDS 203

12.6 MSDS 0732 RTV Silicone 732

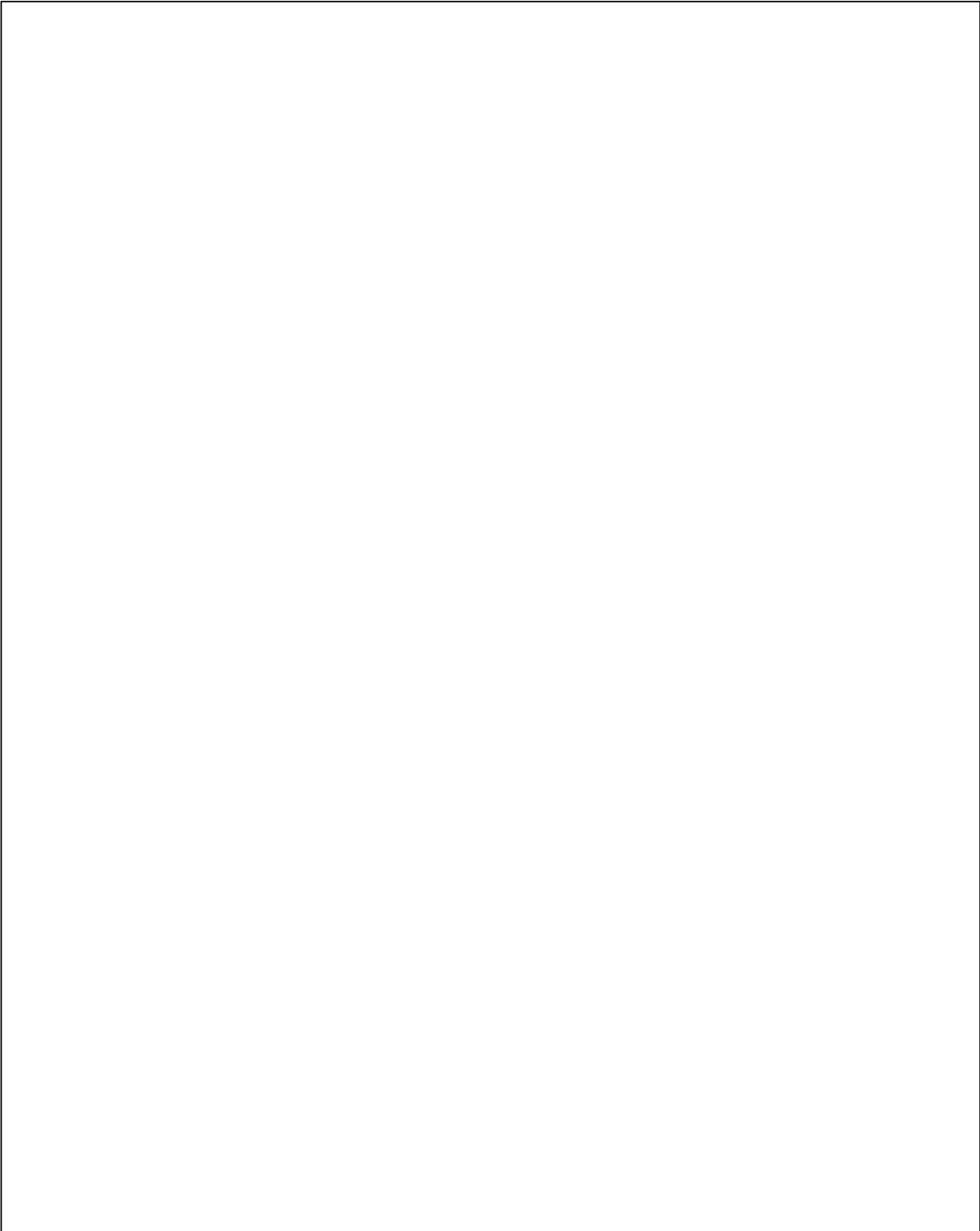
12.7 MSDS MagnaForm Boards

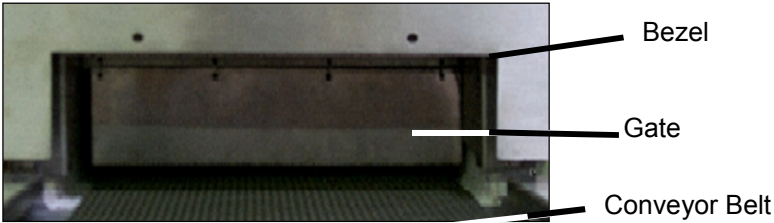
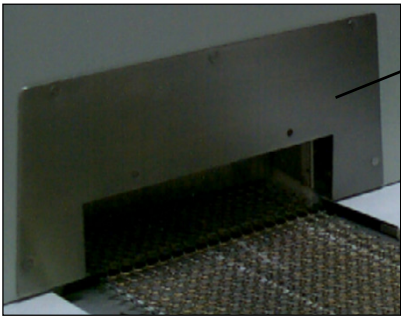

Across-the-Belt	In reference to an area perpendicular to the direction of travel through the furnace; the width of the conveyor belt.
Actual Temperature	The instantaneous temperature in the furnace as reported by the thermocouple.
Air-Rake	Long tube set across-the-belt with proportionally spaced small holes. 
Air-Regulator Tubes	Air rakes charged with air or N2 installed in the entrance and exit baffles, used in establishing a controlled atmosphere.
Blade	Hinged flaps at entrance and exit of furnace that help prevent furnace atmosphere from escaping. See also figure under Drip Trays. 
Bezel	Semi-permanent entrance guard at furnace entrance and exit. See also Gate. 
CCW	Counter clockwise. Turn or rotate to left. 

Chapter 13

CDA	Clean dry air – filtered, dry compressed air used as process gas.
Chamber	See heating chamber.
Clearance	The distance at furnace entrance between the conveyor belt and the bezel. See diagram under bezel.
Contaminants	Anything present in the process section that could negatively impact product quality including but not limited to O ₂ , moisture or particulate matter.
Convection	The process of heating a product via indirect transmission of heat from adjacent high-temperature air.
Controller	Control system that stabilizes temperature, monitors belt speed, alarm conditions and other functions.
Controlled Atmosphere	The atmosphere generated from the process gas, and gas flow patterns within the process section.
Cooling Section	The portion of the furnace that includes the transition tunnel, if any, exit baffle and any additional modules provided for the purpose of cooling the product.
CW	Clockwise. Turn or rotate to right. 
Derivative	The calculated temperature rate of change; used in the PID equation.
Dilution Purge	The continuous process of adding clean gas while exhausting contaminated gas.
Dominant Wavelength	The wavelength of highest occurrence emitted by a radiating element at a specific temperature as described by Wein's Displacement Law.

Drip Trays

Trays positioned beneath stacks with attached baffle gates; used to catch condensation or residue produced by the process.

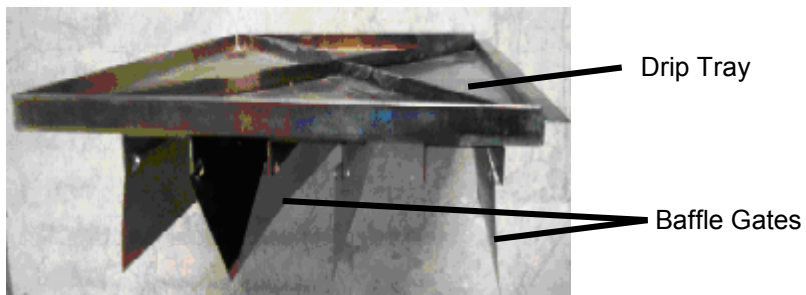

Edge Heater

Heaters along edge of chamber used to maintain uniform temperature across-the-belt in a designated part of the heating chamber.

Eductor

Metered gas exit used to draw exhaust gas out of the chamber and through the stack. See also stack.

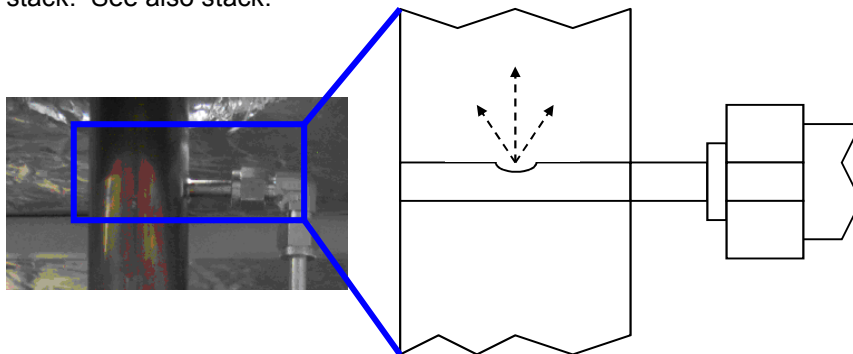



Effluents

Contaminants expelled from a product during a thermal process. See also volatiles.

EMO

An Emergency off switch.

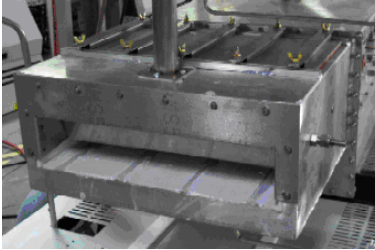

<p>Entrance Baffle</p>	<p>The section at the entrance of the furnace incorporating an air-regulator tube, hanging gates and an exhaust stack; used to establish a controlled atmosphere inside the process section.</p> 
<p>Exhaust Gas</p>	<p>Spent process gas.</p>
<p>Error</p>	<p>Difference between actual temperature and setpoint.</p>
<p>Flash</p>	<p>The point at which organic vapors have reached the temperature and concentration necessary for spontaneous combustion.</p>
<p>Flow Meter</p>	<p>A manually adjustable gauge used to control the flow of gas or liquid to the process section.</p> 
<p>FG or Forming Gas</p>	<p>A type of process gas that consists of any mixture of H₂ and N₂ gasses.</p>
<p>Furnace Length</p>	<p>The length of the entire furnace. The sum of the process section and any loading and unloading stations.</p>
<p>Gain</p>	<p>Term in PID equation to calculate how far temperature is from setpoint.</p>
<p>Gate</p>	<p>Plate that divides furnace into sections that can allow better control of the processing environment. See Blade and Drip Trays for picture.</p>
<p>H₂</p>	<p>Hydrogen gas.</p>

Heat Lamp	Double ended metal sleeve clear quartz infrared (IR) heat lamp element or emitter.
Heated Length	See "Heating Chamber", next.
Heating Chamber	Furnace area where heating takes place. Also referred to as the chamber, or heated length.
Heating Section	The portion of the furnace including the entrance baffle and the heating chamber.
Hydrogen Detector	Detect hydrogen escaping from furnace.
Integral	Mathematical operation that is one term in the PID equation.
Interlocks	Switches on some cabinet doors that stop furnace operation and removes power when doors are opened.
IR	Electromagnetic wave. Wavelengths between 0.78 and 1000 μm in the electromagnetic spectrum.
Lamp Strings	A single lamp circuit which may include one lamp or two or more lamps in series. LA-306 Standard Power furnaces are wired with two lamps per string in zones 1 and 3. Zone 2 is wired with 3 lamps per string. LA-306 High Power furnaces are wired with two lamps per string in all zones
LPM	Liters per minute. Units of flow equivalent to 2.119 CFH.
Micron	One millionth of a meter, $1.0 * 10^{-6}$ m, 1.0 μm
MMI	Man machine interface software development tool for creating user interface to PLC controller.
Module	A section of the furnace designed for a specific function; may be 15, 30, 45 or 60 inches in length.
N₂	Nitrogen gas.
O₂	Oxygen gas.

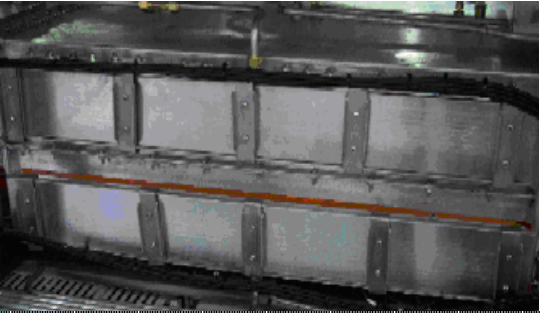
Oxygen Analyzer	Detects oxygen content at predetermined locations. Usually installed to read process gas source, and up to three locations in the heating chamber.
Phase Angle Firing	Technique that activates AC power to be applied for only certain times during AC cycle.
PID	Proportional+Integral+Derivative: Three-term closed loop control equation that adjusts power sent to heat lamps. See also Gain, Integral and Derivative.
PLC	Programmable Logic Controller. An industrial computer which manages input and output control of the furnace.
Plenum	Cutout area of chamber insulation where process gas is injected.
Plenum Box	Pressurized region, enclosing ends of heat lamps, part of the hermetic seal option. 
PPM	Parts per million. Useful ratio for measuring small amounts of one gas in an area dominated by another.
Process Gas	The gas used in creating a controlled atmosphere. Some examples are CDA, N ₂ , H ₂ , forming gas or other N ₂ /H ₂ mixtures.
Process Environment	The description of the area inside the furnace at any time including the temperature, flow patterns, and the presence or absence of product, process gas, process effluents, or contaminants.
Process Section	The physical area inside the furnace from the entrance bezel to the exit bezel. The sum of the heating section and cooling section.
Profile	See Temperature Profile.
Proportional Band	The temperature range used in the PID equation in applying a portion of the available power to the heat lamps based on the deviation of the actual temperature from the setpoint.

Recipe	Instructions, including temperatures and belt speed that the furnace follows.	
Resonant Frequency	The frequency at which the atomic structure of a material is easily excited into physical vibration resulting in excellent heat transfer characteristics.	
SCFH	Standard Cubic Foot per Hour. Measurement for gas flow volume. Equivalent to 0.472 standard liters per minute.	
SCR	Silicon Controlled Rectifier. The electronic device used to regulate power to the heat lamps through signals sent by the controller.	
Setpoint	The target temperature for a zone.	
Sparger Tubes	Highly porous, sintered metal tube charged with process gas; typically used in controlled atmosphere cooling modules.	
Stack	Exhaust stack containing eductor. See also eductor.	
STP	Standard temperature and pressure: 21.1 C (70 F) 1 Atm, 1.013 Bar (14.7 psig)	
Temperature Profile	Temperature recorded over a period of time.	
Thermal Process	The idealized process description for a particular product as it passes through the process section, including the product temperature profile and process environment.	
Thermal Process Profile	Empirical record of the thermal process	
Thermocouple	An electronic device that measures temperature.	

Chapter 13

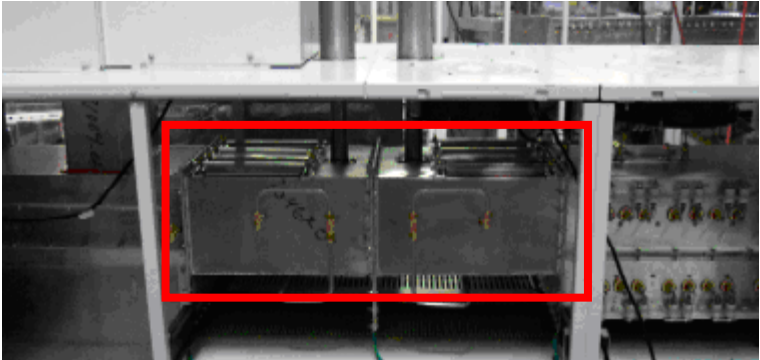
Throat	The throat of the furnace describes the maximum height of any product allowable through the process section.
Transition Tunnel	Chamber section between heat and cooling section. 
Volatiles	Hydrocarbon based product effluents.
With-the-belt	In reference to the area of the conveyor belt that extends through the process section.
Zone	Area within the chamber where temperature can be independently controlled.

14.1 The Rebuilt RTC LA-306

This supplement describes the differences between LCI rebuilt versions of RTC's original LA-306 and the new LCI model described in the core chapters of this manual. Manufactured between 1984 and 2005 by Radiant Technology Corporation, RTC's LA-306 is a compact, near-infrared, conveyor belt furnace for laboratory and general purpose thermal processing in the range of 100-980 °C. Furnaces rebuilt by LCI have the entire control system replaced with modern digital controllers and logic described in this manual.



Figure 14-1 RTC LA-306 Furnace Front Elevation

The RTC LA-306 is a slightly smaller furnace with a chamber length of 700 mm (27.5 inches), 63 mm (2.5 inches) shorter than the LCI model. Entrance and transition baffles are 160 mm (6.25 inches) long, each 220 mm (8.75 inches) shorter than the LCI model. The cooling section is 1015 mm (40 inches) long, 254 mm (10 inches) longer than the LCI model thereby making the combined cooling of the transition baffle and cooling roughly equivalent for both models (1174 mm on the RTC vs. 1143 mm on the LCI)

Similar to the LCI model, it transports product on a 150 mm (6-inch) wide belt with a chamber clearance above the belt of 50 mm (2 inches). RTC LA-306 furnaces feature a hermetically sealed heating chamber permitting control of the furnace chamber process environment. Baffle sections before and after the heating section contain curtains that hang down to just above the belt to further isolate the furnace chamber from the room atmosphere and from the cooling section.

RTC LA-306's can process substrates, wafers, PCBs, metal, ceramic, glass or polycarbonate parts for electronic package sealing, thermo-setting polymer curing, reflow soldering, hybrid/thick film firing, brazing, annealing, tempering and metal sintering applications, or almost any kind of general thermal processing requiring precision temperature control in a controlled atmosphere environment.

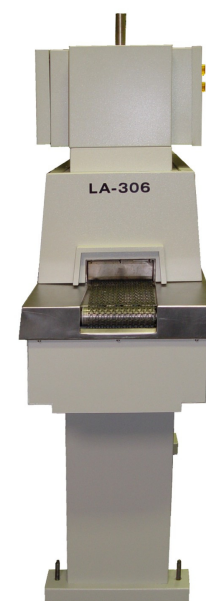

Figure 14-2 Entrance Elevation

14.2 Console Controls & Indicators

14.2.1 Control Console

Control of the furnace is via a control console (Figure 14-3) with completely new front panel, control instruments and electrics installed in the original enclosure mounted over the heating section of the furnace. Original flowmeters have been re-plumbed to support either single or optional dual gas operation as described in Paragraph 2.4.2.

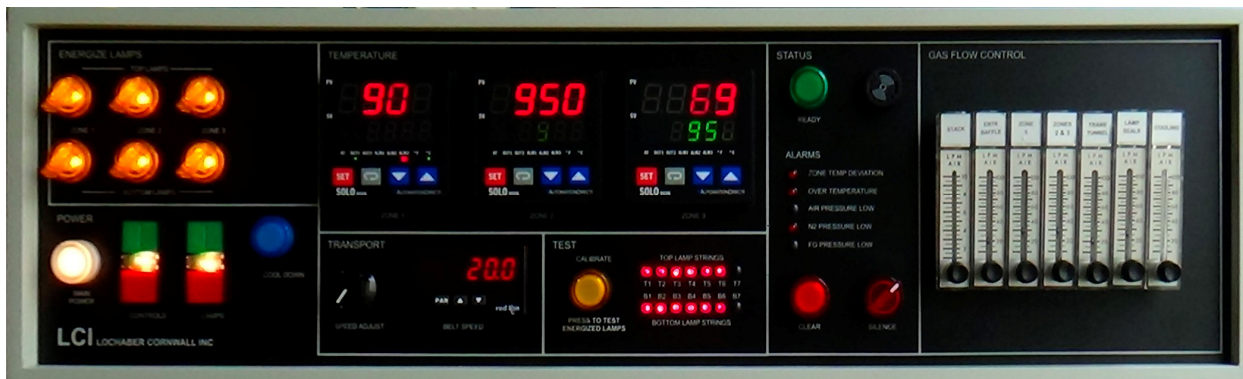

Figure 14-3 RTC LA-306 Control Console

14.2.1 Transport Drive

A. Major Components

The major transport drive components are listed in Table 14-1.

Table 14-1 Transport Drive Components							
Item	Brand	Model	Drive Speed	HP	Torque, (in-LB)	Motor Voltage	Gear Ratio
Controller	Minarik	PCM21010A	-	1/40-1/8	-	90 Vdc	-
Alt Controller*	Iron Horse	GSD4-240-1C	-	1/50-1/8	-	90 Vdc	-
Motor	Bison	011-190-0702	2.6 rpm	1/40	100	90 Vdc	702:1
Encoder	Automation Direct	TRD-NH30-RZWD	30 ppr	4.75-30 Vdc	-	-	-

*2014 models only. Uses GSDA-AI-V4 Isolated Analog Voltage Signal Input Card

B. Motor Controller

The RTC LA-306 includes one of the motor controllers shown below. These motor controllers are set for 90 Vdc motor operation. The motor controller is mounted in the furnace Control Enclosure.

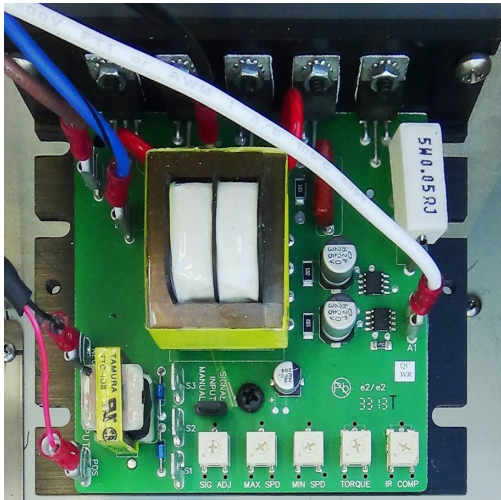

Figure 14-4 Minarik Motor Controller

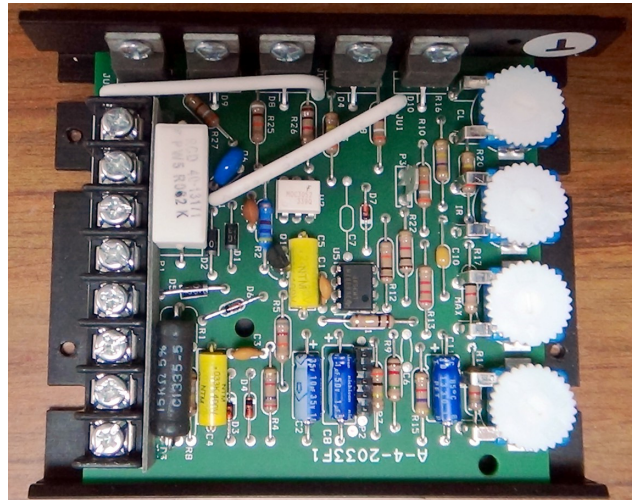

Figure 14-5 IronHorse Motor Controller

When operated in the Manual Mode the motor controller uses the control panel-mounted potentiometer to scale output voltage to the motor. In the Normal (or automatic) Mode the PLC averages the pulse counts from the encoder and modifies the signal to the motor controller to maintain motor speed using a PID loop.

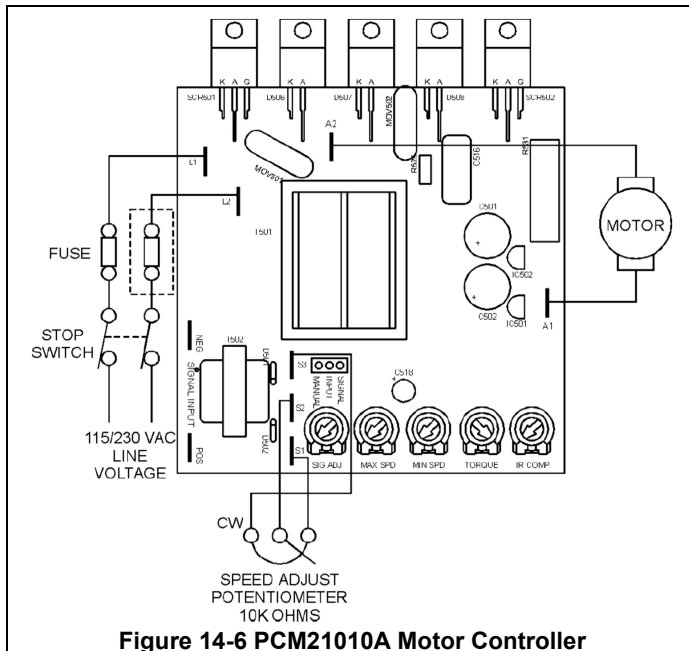

Figure 14-6 PCM21010A Motor Controller

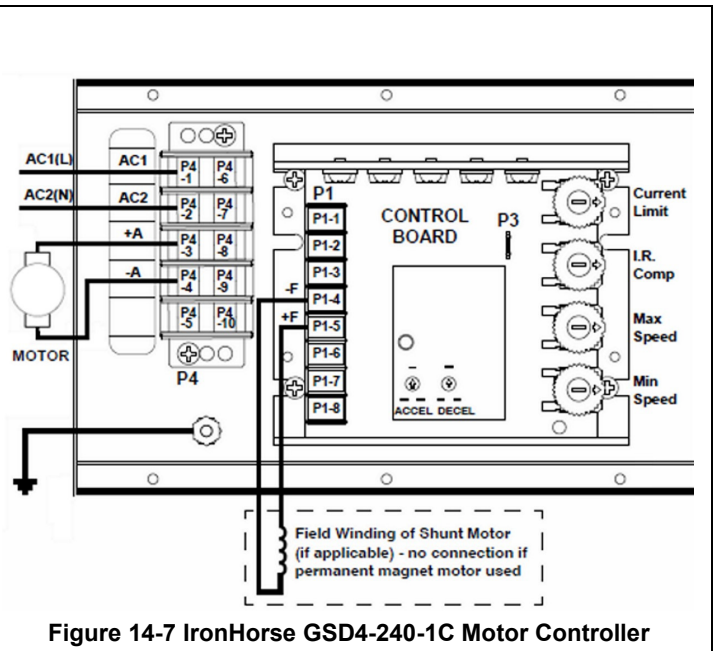

Figure 14-7 IronHorse GSD4-240-1C Motor Controller

2014 models used the IronHorse controller which requires the use of an added card to accommodate the incoming dc analog signal from the PLC. Models after 2014 incorporate the Minarik controller which has the ability to receive dc analog signals without an additional board. Either board can be installed to run the furnace.

C. Transport Drive Motor

The transport drive motor is a 1/40 HP TENV Brushless parallel shaft DC gearmotor and encoder assembly. The transport motor assembly is mounted in an enclosure at the exit end of the furnace. Drive chain and motor sprocket sized to provide the desired belt speed range shown in Table 1-4. The motor is shown in Figure 1-27 and Figure 1-28.



Figure 14-8 Drive Motor

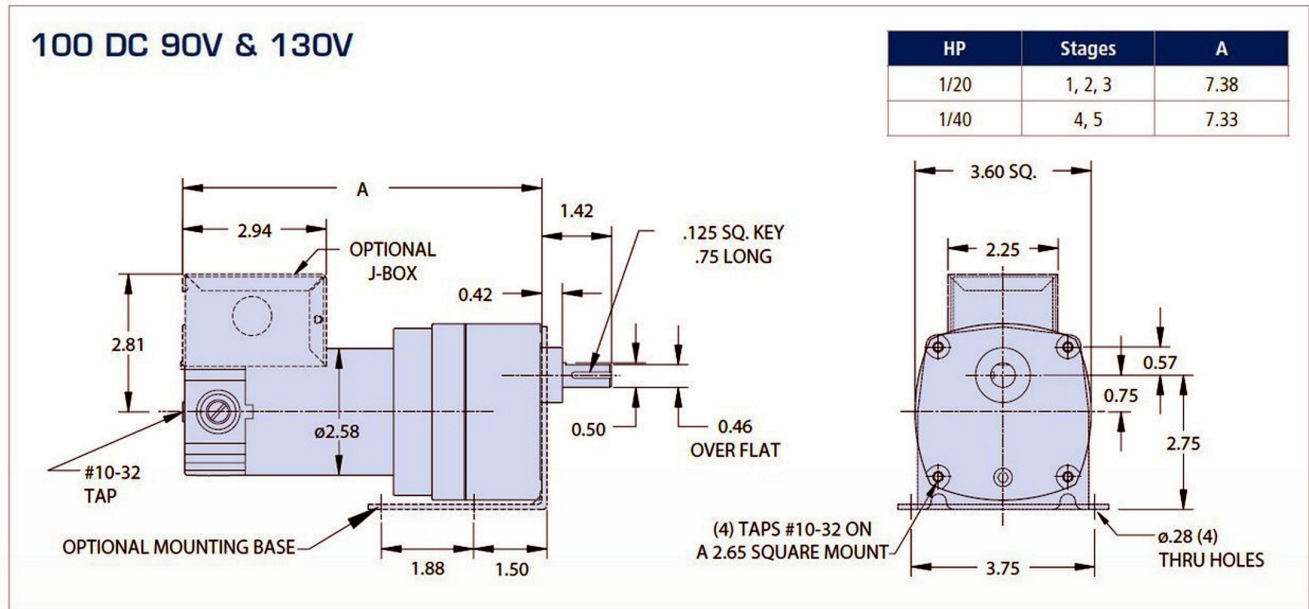

Figure 14-9 Transport Drive DC Motor

D. Speed Encoder

The motor is equipped with a 30 pulse per revolution dual channel 5-30 Vdc push-pull encoder (Figure 1-29). One channel is connected to the rate meter to report the belt speed, the other to the PLC to lock in the belt speed.

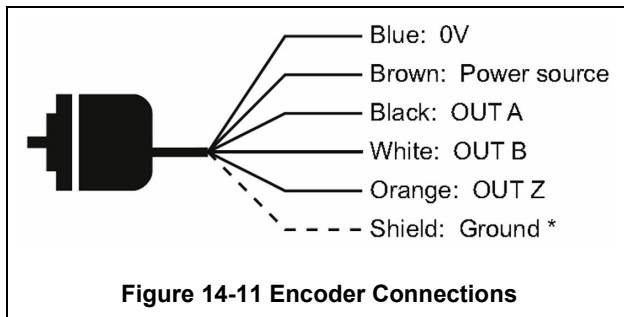

Figure 14-10 Encoder

14.3 Installation

Once located, ¼-inch diameter concrete fasteners, or equivalent, should be used to assure the RTC LA-306 model is safely secured to the facility floor. To complete proper installation follow the guidelines in Chapter 2 of this manual except as noted on drawing 803-100267 INSTALLATION DRAWING in this Chapter.

14.4 Initial Setup

Except as noted below, follow the instructions in Chapter 3 of this manual.

14.5 Operation

Except as noted below, follow the instructions in Chapter 4 of this manual.

14.6 Modifying Control Strategies

Follow the instructions in Chapter 5 of this manual.

14.7 Service & Maintenance

The guidelines Chapter 7 of this manual apply to refurbished RTC LA-306 furnaces except as noted for various installed motor equipment.

14.7.1 Motor and Motor Controller

The RTC LA-306 furnace is equipped with a 1/50 HP Bodine N1D shunt-wound 1728:5.76 rpm DC gearmotor. Alternately, a 1/40 HP Bison 100 series PMDC permanent magnet TENV 1790:6.6 rpm gearmotor may be installed. See Frame Wiring Diagram 802-101781-02 in this chapter and detail corresponding to your motor.

14.8 MSDS

The MSDS in Chapter 12 of this manual apply to refurbished RTC LA-306 furnaces.

14.9 Specifications

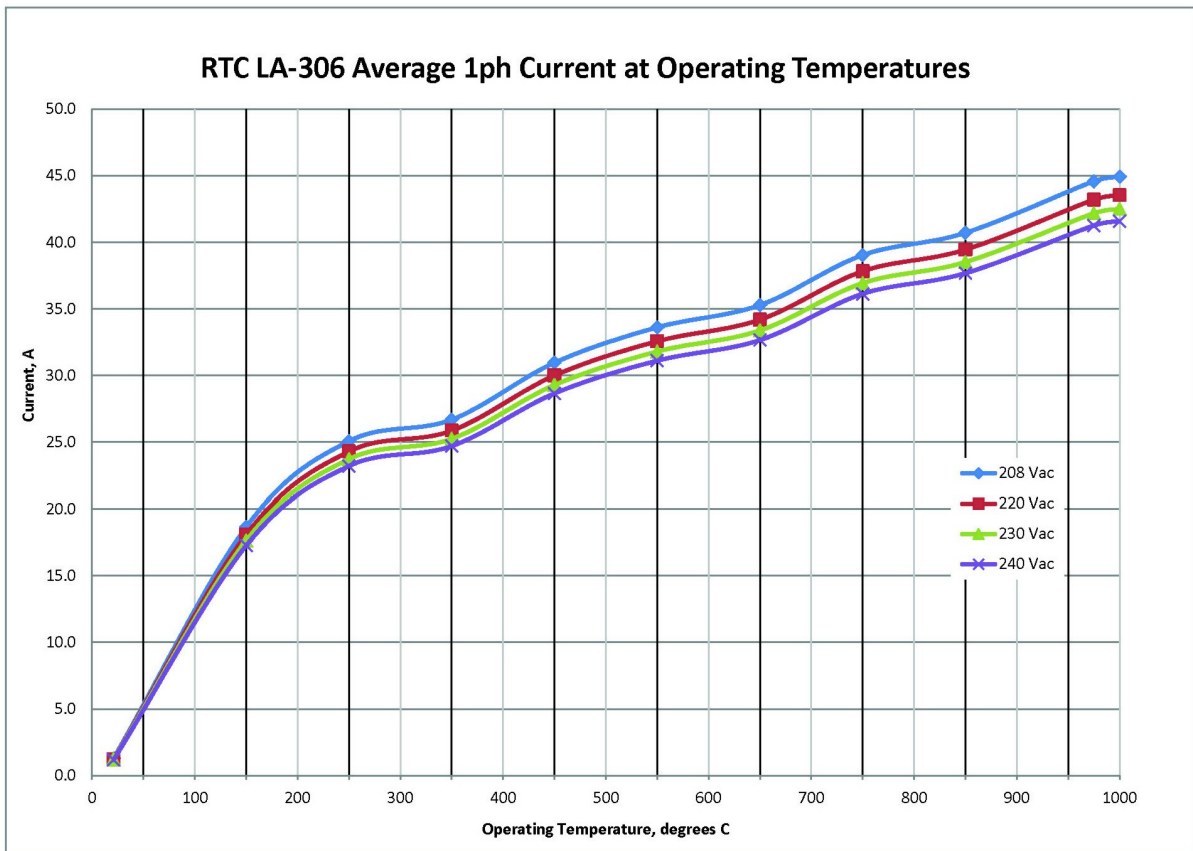
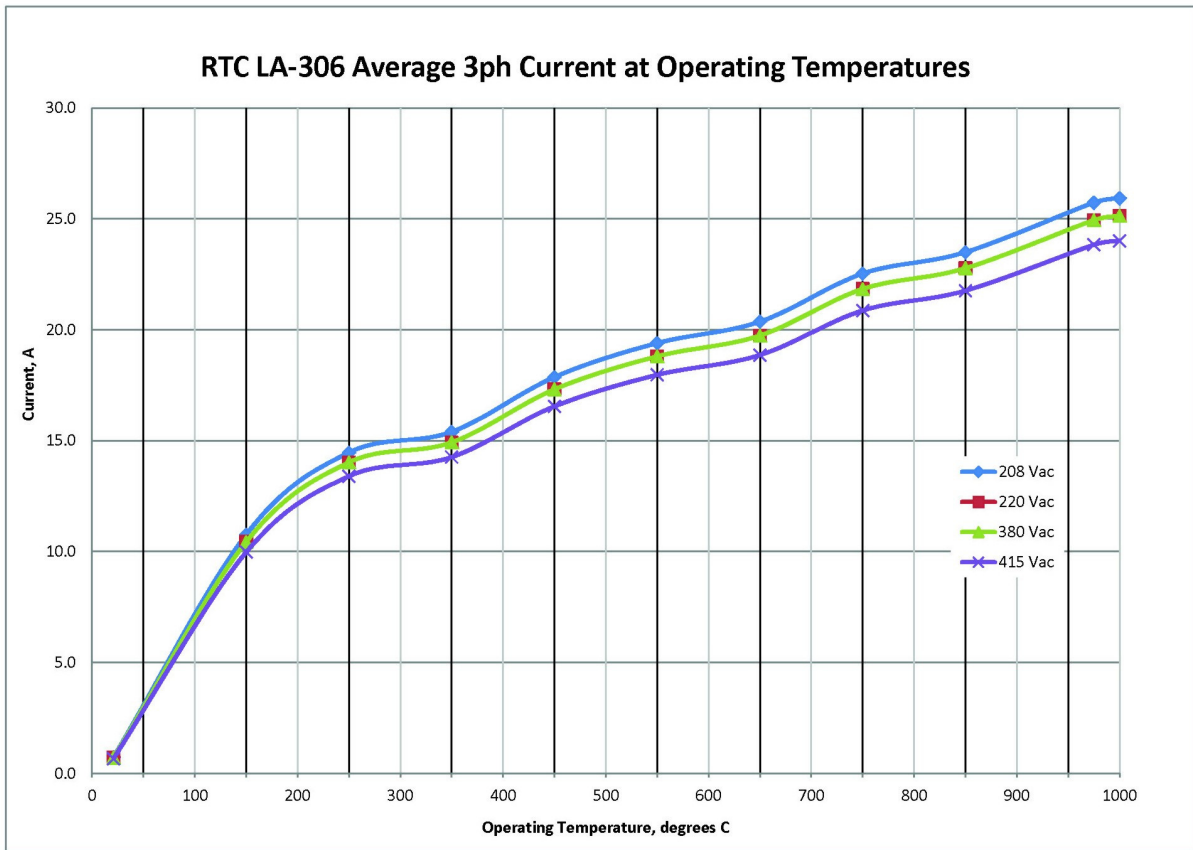

Expected three phase current draw when stabilized at various temperatures.

14.11 RTC LA-306 DRAWINGS

Refer to the following drawings in lieu of the corresponding drawings in Chapter 10. RTC's furnace chamber drawing is included to illustrate its smaller size. Two versions of the Frame Wiring drawing are included depending upon the model of Belt Speed tachometer supplied. Table 14-2 lists the drawings that are specific to an LCI rebuilt LA-306.

Table 14-2 Applicable Drawings for LCI Rebuilt RTC LA-306		
Master	Drawing Nbr.	Title
STD	803-100267	FURNACE ARRANGEMENT, RTC LA-306
STD	803-091734-02	RTC LA-306 FURNACE CHAMBER
STD	802-101781-02	FRAME WIRING SCH

14.12 Furnace Arrangement, RTC LA-306

14.13 Furnace Chamber, RTC LA-306

14.14 Frame Wiring – Refurb RTC LA-306

Furnace Configuration

15.1.1 Furnace Configuration Checklist

